

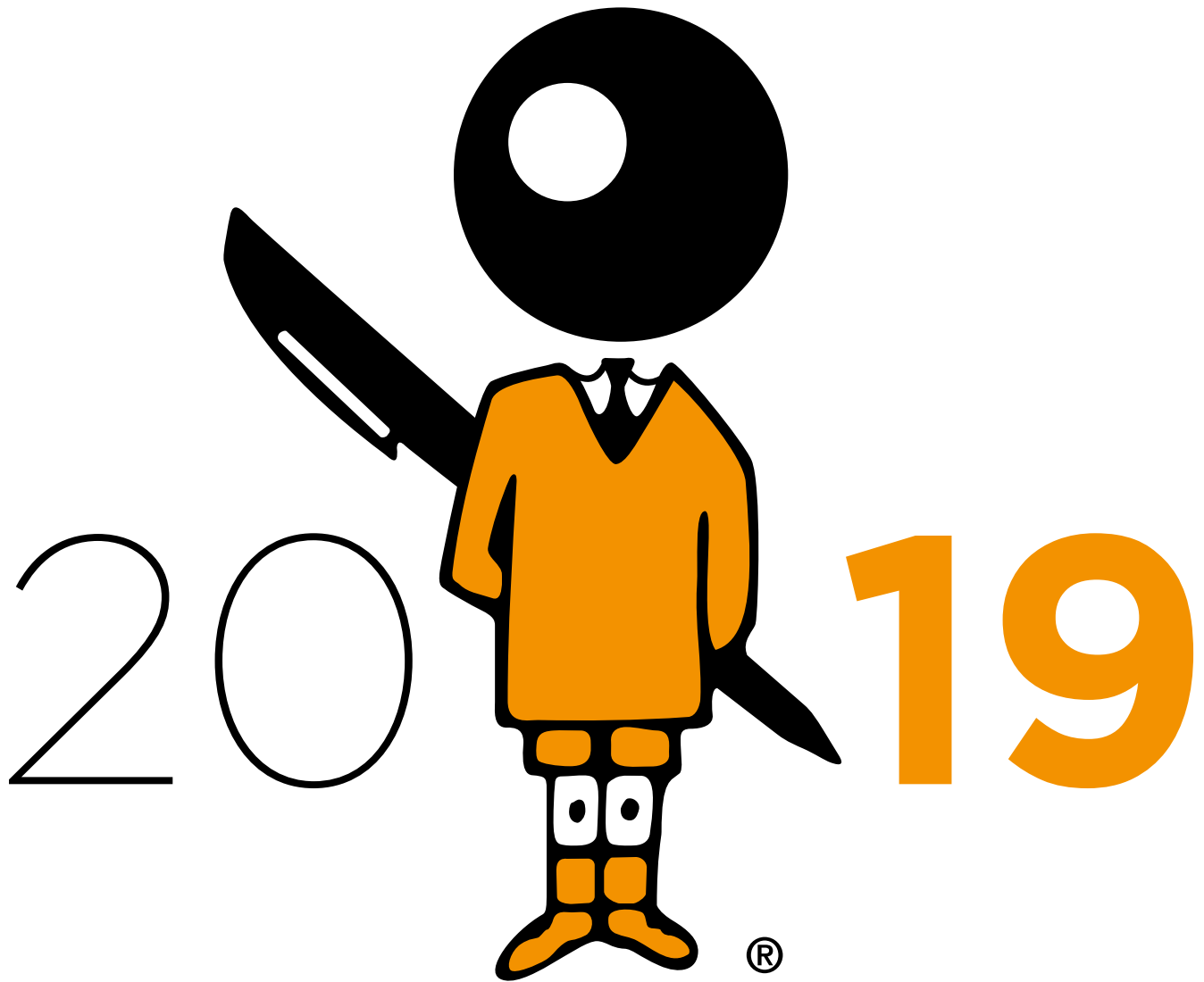

Your Brand Ambassador



WHAT'S BETTER THAN A REAL BRAND
TO PROMOTE YOURS?

> WRITING INSTRUMENTS > STICKY NOTES > NOTEBOOKS > OFFICE ACCESSORIES > LIGHTERS&CASES > SHAVERS > BAGS > TECHNOLOGY > PACKAGING



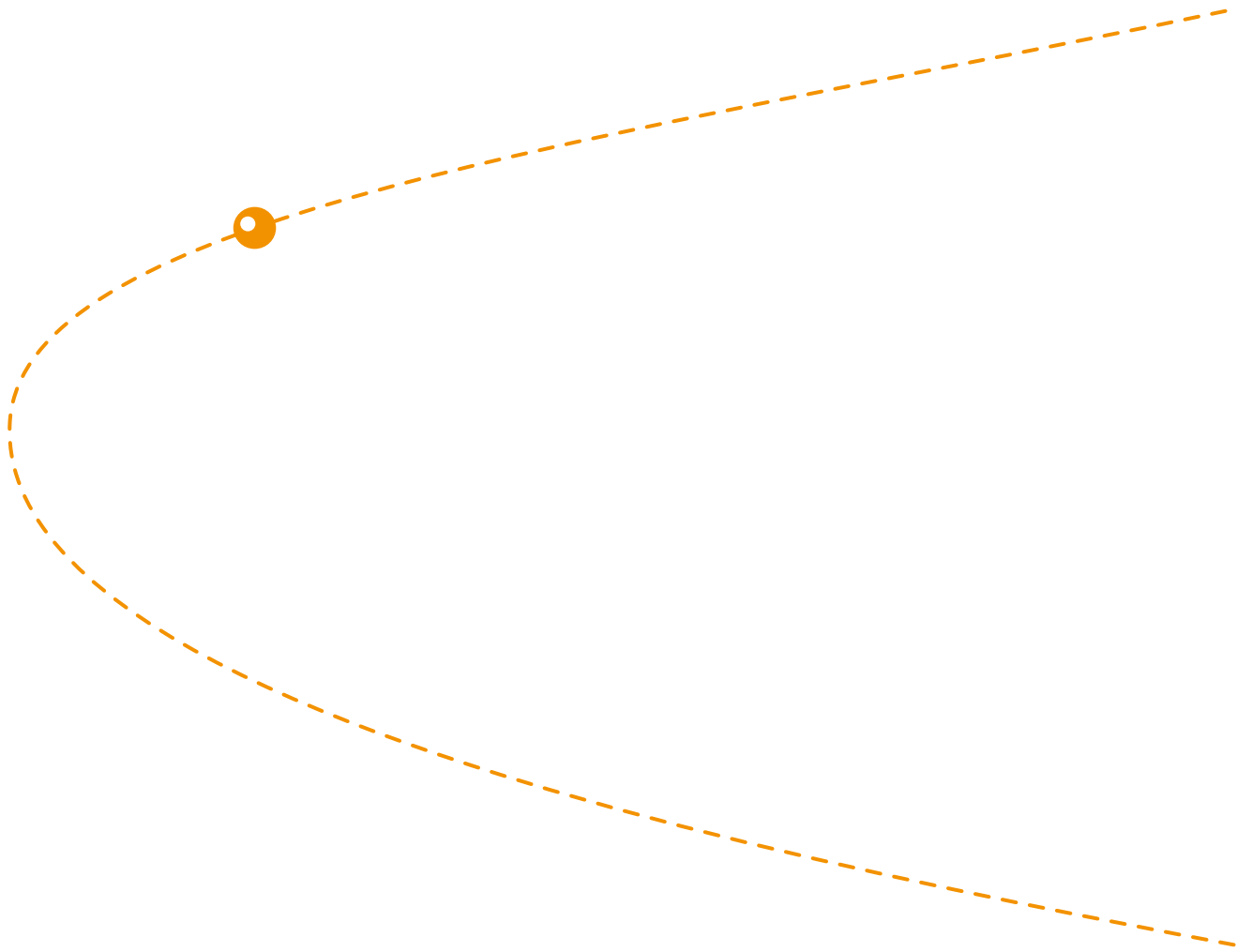



**WHAT'S BETTER THAN A REAL BRAND
TO PROMOTE YOURS?**



FR> Group

UNE PRÉSENCE MONDIALE

BIC® fabrique dans 24 de ses propres usines réparties dans le monde, pour mieux répondre aux demandes d'expertises produits et mieux servir les marchés locaux.

- 24 USINES À TRAVERS LE MONDE
- 160 PAYS
- 14,934 EMPLOYÉS DANS LE MONDE

- LA PRODUCTION COMBINÉE DE NOS 24 SITES GÉNÈRE 90 %* DES REVENUS DU GROUPE
- 100 % DES INSTRUMENTS D'ÉCRITURE SONT IMPRIMÉS CHEZ BIC GRAPHIC EUROPE
- NOUS PRODUISONS PRÈS DE CHEZ NOS CLIENTS

- 5 BRIQUETS
- 14 PAPETERIE
- 4 RASOIRS
- 1 ARTICLES PROMOTIONNELS

* EXCEPTÉ LES STYLOS CELLO

DE> Group

EINE GLOBALE PRÄSENZ

BIC® besitzt und betreibt weltweit 24 Hauptwerke, die basierend auf spezifischer Produkterfahrung aufgebaut wurden und um die lokalen Märkte der Gruppe besser bedienen zu können.

- 24 FABRIKEN WELTWEIT
- 160 LÄNDER
- 14,934 MITARBEITER WELTWEIT

- DIE KOMBINIERTER PRODUKTION DER 24 WERKE ERZEUGT 90%* DER UMSATZERLÖSE DES KONZERNS
- UND DAVON WERDEN 100% DER SCHREIBWAREN IN BIC GRAPHIC EUROPE BEDRUCKT
- WIR PRODUZIEREN IN KUNDENNÄHE

- 5 FEUERZEUGE
- 14 SCHREIBWAREN
- 4 RASIERER
- 1 WERBEARTIKEL

* AUSSGENOMMEN CELLO PENS

ES> Group

UNA PRESENCIA GLOBAL

BIC® posee y mantiene 24 plantas principales en todo el mundo, desarrolladas según el producto específico expertisen y para servir mejor a los mercados del Grupo a nivel local.

- 24 FÁBRICAS ALREDEDOR DEL MUNDO
- 160 PAÍSES
- 14,934 EMPLEADOS EN TODO EL MUNDO

- LA PRODUCCIÓN DE LAS 24 FÁBRICAS JUNTAS GENERA EL 90 %* DE LOS INGRESOS DEL GRUPO
- EL 100 % DE LOS INSTRUMENTOS DE ESCRITURA SE IMPRIMEN EN BIC GRAPHIC EUROPE
- PRODUCIMOS CERCA DE NUESTROS CLIENTES

- 5 ENCENDEDORES
- 14 ESCRITURA
- 4 MAQUINILLAS DE AFEITAR
- 1 PROMOCIONAL

* EXCLUYENDO LOS BOLÍGRAFOS CELLO

IT> Group

UNA PRESENZA MONDIALE

BIC® possiede e gestisce 24 impianti principali in in tutto il mondo, sviluppati secondo la specifica competenza di prodotto e per servire al meglio i mercati del Gruppo localmente.

- 24 FABBRICHE IN TUTTO IL MONDO
- 160 PAESI
- 14,934 IMPIEGATI A LIVELLO MONDIALE

- LA PRODUZIONE COMBINATA DEI 24 SITI GENERA IL 90%* DEL FATTURATO DEL GRUPPO
- IL 100% DEGLI STRUMENTI DI SCRITTURA VENGONO STAMPATI IN BIC GRAPHIC EUROPE
- PRODUCIAMO VICINO AI NOSTRI CLIENTI

- 5 ACCENDINI
- 14 ARTICOLI DI CANCELLERIA
- 4 RASOI
- 1 PRODOTTI PROMOZIONALI

* ESCLUSE LE PENNE CELLO





A GLOBAL PRESENCE

BIC Group owns and maintains **24 principal plants around the world**, developed according to specific product

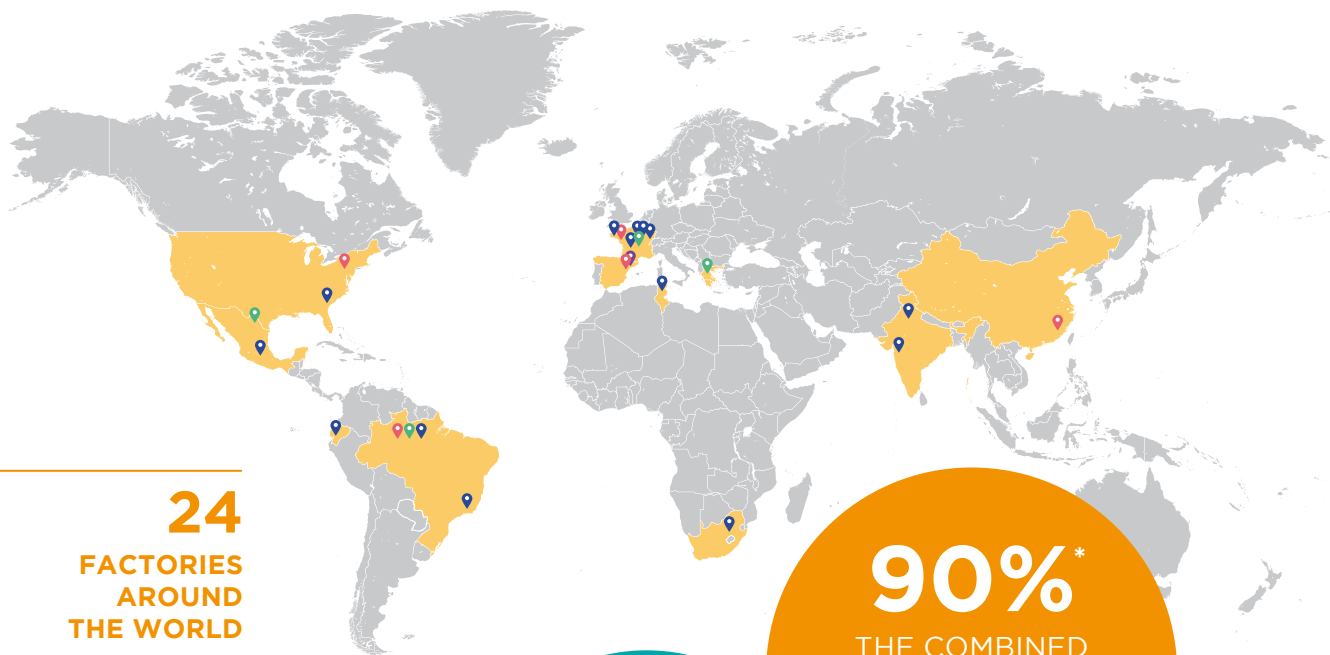

24
FACTORIES
AROUND
THE WORLD

160
COUNTRIES
IN WHICH
BIC® PRODUCTS
ARE AVAILABLE

14,934
EMPLOYEES
WORLDWIDE

AND OF THESE, THE
100%
OF WRITING
INSTRUMENTS
ARE PRINTED IN
BIC GRAPHIC
EUROPE

90%*
THE COMBINED
PRODUCTION OF THE
24 SITES GENERATES
90% OF THE GROUP'S
REVENUE

WE
PRODUCE
CLOSE
TO OUR
CUSTOMERS

5 LIGHTERS
FACTORIES

14 STATIONERY
FACTORIES

4 SHAVERS
FACTORIES

1 PROMOTIONAL PRODUCTS
FACTORIES

*EXCLUDING CELLO PENS



FR> Un peu d'histoire...

1944

MARCEL BICH ET EDOUARD BUFFARD

En 1944, Marcel Bich (1914-1994) achète une usine à Clichy, en France, et se lance dans la fabrication de pièces d'instruments d'écriture avec son associé Édouard Buffard (1908-1996).

1950

NAISSANCE DU BIC® CRISTAL®

Convaincu du potentiel du stylo à bille, Marcel Bich adapte et améliore un stylo à bille inventé par le Hongrois László Bíró. En décembre 1950, il lance en France son propre stylo à bille sous la marque BIC®, une version raccourcie de son propre nom qui se retient plus facilement. Grâce à sa qualité et à son prix abordable, le stylo à bille BIC® Cristal® est rapidement adopté par un nombre croissant de consommateurs.

1954

EXPANSION EN ITALIE

BIC® s'établit en Italie, puis aux Pays-Bas, en Autriche, en Suisse et en Espagne.

1957

DÉVELOPPEMENT AU ROYAUME-UNI ET DANS LA ZONE STERLING

BIC® achète Biro Swan au Royaume-Uni, et s'implante en Irlande, en Australie, en Nouvelle-Zélande et en Afrique du Sud.

ES> Un poco de historia...

1944

MARCEL BICH Y EDOUARD BUFFARD

En 1944, Marcel Bich (1914-1994) compra una fábrica en Clichy (Francia) y establece un negocio con su socio, Édouard Buffard (1908-1996), como fabricante de piezas de instrumentos de escritura.

1950

NACIMIENTO DE BIC® CRISTAL®

Convencido del potencial del bolígrafo, Marcel Bich adapta y mejora una esferográfica inventada por el húngaro László Bíró y, en diciembre de 1950, lanza en Francia su propio bolígrafo bajo la marca BIC®, una versión abreviada y más fácil de recordar de su apellido. Gracias a su calidad y a su precio asequible, el bolígrafo BIC® Cristal® es adoptado rápidamente por cada vez más consumidores.

1954

EXPANSIÓN A ITALIA

BIC® se establece en Italia y, más tarde, en los Países Bajos, Austria, Suiza y España.

1957

LLEGADA AL REINO UNIDO Y LA ZONA ESTERLINA

BIC® adquiere Biro Swan en el Reino Unido y, gracias a ello, se expande a Irlanda, Australia, Nueva Zelanda y Sudáfrica.

DE> Ein Stück Geschichte...

1944

MARCEL BICH UND EDOUARD BUFFARD

1944 kauft Marcel Bich (1914-1994) in Clichy, Frankreich, eine Fabrik und gründet mit seinem Geschäftspartner Édouard Buffard (1908-1996), einem Hersteller von Teilen für Schreibgeräte, ein Unternehmen.

1950

GEBURTSTUNDE DES BIC® CRISTAL®

Marcel Bich glaubte an das Potenzial des Kugelschreibers, daher adaptierte und optimierte er den von dem Ungar László Bíró entwickelten Kugelschreiber. Im Dezember 1950 brachte er in Frankreich seinen eigenen Kugelschreiber unter dem Markennamen BIC® heraus. BIC ist eine kürzere und einprägsamere Version seines eigenen Namens. Dank seiner Qualität und seines erschwinglichen Preises wurde der BIC® Cristal®-Kugelschreiber schnell von einer wachsenden Zahl von Verbrauchern angenommen.

1954

EXPANSION IN ITALIEN

BIC eröffnet Niederlassungen in Italien, den Niederlanden, Österreich, der Schweiz und Spanien.

1957

ENTWICKLUNG IM VEREINIGTEN KÖNIGREICH VON GROSSBRITANNIEN UND NORDIRLAND

BIC® übernimmt Biro Swan im Vereinigten Königreich von Grossbritannien und Nordirland und erschließt sich damit die Märkte von Irland, Australien, Neuseeland und Südafrika.

IT> Un po' di storia...

1944

MARCEL BICH ED EDOUARD BUFFARD

Nel 1944, Marcel Bich (1914-1994) acquista una fabbrica a Clichy, in Francia, e con il suo socio Édouard Buffard (1908-1996) avvia un'attività commerciale per la realizzazione di pezzi per strumenti di scrittura.

1950

NASCITA DELLA BIC® CRISTAL®

Marcel Bich, credendo nel potenziale della penna a sfera, adatta e migliora la penna a sfera inventata dall'ungherese László Bíró e, nel dicembre 1950, lancia in Francia la penna sfera con il marchio BIC®, una versione abbreviata del suo cognome, più semplice da ricordare. Grazie alla qualità e al prezzo accessibile, la penna a sfera BIC® Cristal® viene rapidamente adottata da un numero sempre più crescente di consumatori.

1954

ESPANSIONE IN ITALIA

Ingresso di BIC® in Italia, poi in Olanda, Austria, Svizzera e Spagna.

1957

SVILUPPO NEL REGNO UNITO E NELLA ZONA DELLA STERLINA

BIC® acquisisce Biro Swan nel Regno Unito muovendosi poi in Irlanda, Australia, Nuova Zelanda e Sud Africa.



A bit of story...



1944

MARCEL BICH AND EDOUARD BUFFARD

In 1944, Marcel Bich (1914-1994) buys a factory in Clichy, France, and sets up business with his partner, Édouard Buffard (1908-1996), as a maker of writing instruments parts.



1954

EXPANSION IN ITALY

BIC® establishes a presence in Italy, then in the Netherlands, Austria, Switzerland and Spain.



1950

BIRTH OF BIC® CRISTAL®

Marcel Bich, believing in the potential for the ballpoint pen, adapts and improves the ballpoint invented by the Hungarian László Bíró, and in December 1950, launches his own ballpoint pen in France under the BIC® brand, a shortened and more memorable version of his own name. The quality and affordable price of the BIC® Cristal® ballpoint pen means that it is quickly adopted by an increasing number of consumers.



1957

DEVELOPMENT IN THE UNITED KINGDOM AND THE STERLING ZONE

BIC® acquires Biro Swan in the UK, thereby moving into Ireland, Australia, New Zealand & South Africa.



FR> Un peu d'histoire...

1959

BIC® EN SCANDINAVIE

BIC® entre sur le marché scandinave.

1960

BIC® EN AFRIQUE ET AU MOYEN-ORIENT

BIC® se développe progressivement en Afrique et au Moyen-Orient en vendant ses produits par l'intermédiaire de distributeurs locaux.

1961

LE LOGO BIC® BOY EST CRÉÉ

C'est également un dessinateur français, Raymond Savignac, qui créa un personnage avec une tête en forme de bille pour la campagne "Nouvelle Bille" en 1960. Ce petit bonhomme est ensuite placé à côté des lettres B, I et C, le tout coloré en orange. Ce logo est resté identique depuis lors et la couleur orange est devenue la couleur officielle de BIC®.

1970

LANCEMENT DU BIC® 4-COULEURS™

Lancement du stylo BIC® 4-Couleurs™.

DE> Ein Stück Geschichte...

1959

BIC® IN SKANDINAVIEN

BIC® betritt den skandinavischen Markt.

1960

BIC® IN AFRIKA UND DEM NAHEN OSTEN

BIC erschließt sich schrittweise die Märkte in Afrika und dem Nahen Osten durch den Vertrieb seiner Produkte mit regionalen Vertriebspartnern.

1961

DAS BIC® BOY-LOGO ENTSTEHT

Raymond Savignac entwirft eine Figur mit einem Kugelschreiberkopf für die Kampagne "Nouvelle Bille" (neuer Kugelschreiber) 1960. Dieser kleine Junge wird dann neben die Buchstaben B-I-C gestellt, und alles in orange koloriert. Das Logo wurde seither nicht mehr verändert und Orange wurde zu BICs offizieller Unternehmensfarbe.

1970

EINFÜHRUNG DES BIC® 4-COLOR™

Einführung des BIC® 4-Color™-Kugelschreibers.

ES> Un poco de historia...

1959

BIC® EN ESCANDINAVIA

BIC® entra en el mercado escandinavo.

1960

BIC® EN ÁFRICA Y ORIENTE MEDIO

BIC® se establece progresivamente en África y regiones de Oriente Medio mediante la venta de productos a través de distribuidores locales.

1961

SE CREA EL LOGOTIPO DEL NIÑO BIC®

Raymond Savignac crea un personaje con cabeza de bolígrafo para la campaña «Nouvelle Bille» (nuevo bolígrafo) en 1960. El niño se coloca junto a las letras B-I-C y ambos se vuelven naranjas. El logotipo no se ha cambiado desde entonces y el naranja se convirtió en el color oficial de BIC®.

1970

LANZAMIENTO DE BIC® 4-COLOR™

Lanzamiento del bolígrafo BIC® 4-Color™.

IT> Un po' di storia...

1959

BIC® IN SCANDINAVIA

BIC® entra nel mercato scandinavo.

1960

BIC® IN AFRICA E NEL MEDIO ORIENTE

BIC® si sviluppa progressivamente in Africa e nelle regioni del Medio Oriente vendendo prodotti attraverso distributori locali.

1961

CREAZIONE DEL LOGO OMINO BIC®

Raymond Savignac crea un personaggio con una testa a forma di sfera per la campagna pubblicitaria "Nouvelle Bille" (nuova sfera) del 1960. Questo omino viene poi posizionato vicino alle lettere B-I-C, colorate di arancione. Da quel momento il logo rimane invariato e l'arancione diventa il colore ufficiale di BIC®.

1970

LANCIO DI BIC® 4-COLOR™

Lancio della penna BIC® 4-Color™.

A bit of story...



1959

BIC® IN SCANDINAVIA

BIC® enters the Scandinavian market.



1961

THE BIC® BOY LOGO IS CREATED

Raymond Savignac creates a character with a ballpoint head for the "Nouvelle Bille" (new ballpoint) campaign in 1960. This little boy is then placed next to the letters B-I-C, both turned to orange. The logo has remained unchanged ever since and orange became BIC®'s official color.



1960

BIC® IN AFRICA AND THE MIDDLE EAST

BIC® progressively develops the Africa and Middle East regions by selling products through local distributors.

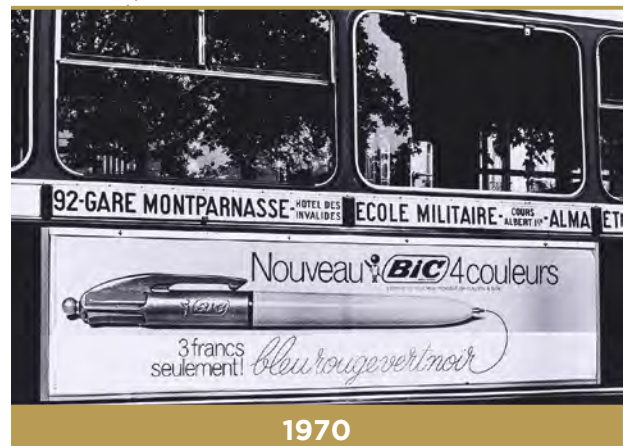

1970

LAUNCH OF BIC® 4-COLOR™

Launch of the BIC® 4-Color™ pen.

FR> Un peu d'histoire...

1973

LE GROUPE BIC® DIVERSIFIE SON CATALOGUE DE PRODUITS AVEC LE BRIQUET DE POCHE

Un an après l'acquisition de Flaminaire, un fabricant français de briquets de qualité, BIC lance le premier briquet de poche BIC® avec une flamme ajustable. Sa fiabilité et sa qualité lui assurent un succès immédiat.

1975

LANCEMENT DU PREMIER RASOIR MONOBLOC

En partenariat avec Viorex, un fabricant grec de lames de rasoir, BIC® devient la première marque à lancer un rasoir monobloc.

1979

LE GROUPE BIC® AJOUTE CONTÉ® À SON CATALOGUE

Le Groupe BIC® fait l'acquisition de Conté®, une célèbre marque française de produits de dessin et de coloriage créée deux siècles auparavant.

1997

BIC® AJOUTE TIPP-EX® À SON CATALOGUE

BIC® achète la marque Tipp-Ex®, le leader européen des produits de correction.

ES> Un poco de historia...

1973

BIC® DIVERSIFICA SU CARTERA DE PRODUCTOS CON EL ENCENDEDOR DE BOLSILLO

Tras la adquisición de Flaminaire, fabricante francés de encendedores de calidad, el año anterior, BIC® lanza el primer encendedor de bolsillo de tamaño grande y con llama ajustable. Su fiabilidad y calidad lo convirtieron en un éxito inmediato.

1975

LANZAMIENTO DE LA PRIMERA MAQUINILLA DE AFEITAR DE UNA SOLA PIEZA

Después de asociarse con Viorex, un fabricante griego de cuchillas de afeitar, BIC® es la primera marca en lanzar una maquinilla de afeitar de una sola pieza.

1979

BIC® AÑADE CONTÉ® A SU CATÁLOGO

El Grupo BIC adquiere Conté®, famosa marca francesa con 200 años de antigüedad de productos para dibujar y colorear.

1997

BIC® AÑADE TIPP-EX® A SU CATÁLOGO

BIC® adquiere la marca Tipp-Ex®, marca europea líder en productos de corrección.

DE> Ein Stück Geschichte...

1973

BIC ERWEITERT SEIN PRODUKTPORTFOLIO DURCH DAS FEUERZEUG

Nach dem Erwerb von Flaminaire, einem französischen Hersteller von hochwertigen Feuerzeugen im Jahr zuvor, bringt BIC das erste BIC®-Feuerzeug mit einstellbarer Flamme auf den Markt. Aufgrund seiner Zuverlässigkeit und Qualität hat es sofort durchschlagenden Erfolg.

1975

EINFÜHRUNG DES ERSTEN EINWEG-RASIERERS

Nach dem Zusammenschluss mit Viorex, einem griechischen Hersteller von Rasierklingen, ist BIC die erste Marke, die einen Einweg-Rasierer auf den Markt bringt.

1979

BIC ERGÄNZT SEIN PORTFOLIO DURCH CONTÉ®

BIC übernimmt Conté®, eine renommierte französische Marke für Zeichen- und Malprodukte mit 200jähriger Tradition.

1997

BIC ERGÄNZT SEIN PORTFOLIO DURCH TIPP-EX®

BIC übernimmt die Marke Tipp-Ex®, die führende europäische Marke für Korrekturprodukte.

IT> Un po' di storia...

1973

BIC® DIVERSIFICA IL PORTAFOGLIO PRODOTTI CON L'ACCENDINO TASCABILE

Dopo aver acquisito Flaminaire, un produttore francese di accendini di alta qualità, BIC® lancia il primo accendino tascabile BIC® maxi con fiamma regolabile. La sua affidabilità e qualità ne fanno immediatamente un prodotto di successo.

1975

LANCIO DEL PRIMO RASOIO MONOLAMA

A seguito di un accordo con Viorex, produttore greco di lame per rasoi, BIC® è il primo marchio a lanciare il rasoio monolama.

1979

BIC® AGGIUNGE CONTÉ® AL SUO PORTAFOGLIO

Il Gruppo BIC acquisisce Conté®, un celebre marchio francese di articoli da disegno e per colorare nato ben due secoli prima.

1997

BIC® AGGIUNGE TIPP-EX® AL SUO PORTAFOGLIO

BIC® acquista Tipp-Ex®, il marchio europeo leader nella produzione di prodotti per la correzione.





1973

BIC® DIVERSIFIES ITS PRODUCT PORTFOLIO WITH THE POCKET LIGHTER

After acquiring Flaminaire, a French manufacturer of high-quality lighters the year prior, BIC® launches the first BIC® full-size pocket lighter with an adjustable flame. Its reliability and quality make it an immediate success.

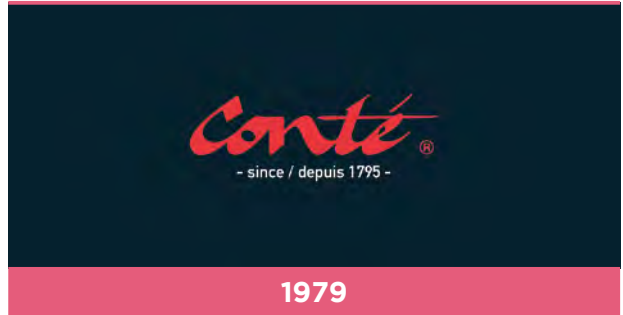

1979

BIC® ADDS CONTÉ® TO ITS PORTFOLIO

BIC Group acquires Conté®, a famous 200-year-old French brand of drawing and coloring products.



1975

LAUNCH OF THE FIRST ONE-PIECE RAZOR

After partnering with Viorex, a greek manufacturer of razor blades, BIC® is the first brand to launch a one-piece razor.



1997

BIC® ADDS TIPP-EX® TO ITS PORTFOLIO

BIC® purchases the TIPP-EX® brand, the leading European brand of correction products.



FR> Un peu d'histoire...

UNE MARQUE ASSOCIÉE À UN LOGO

Les produits et la marque BIC® se sont imposés comme un symbole du design et du produit intemporel. Des produits culte, de conception intelligente, qui ont mérité de faire partie de la collection permanente du Musée national d'Art moderne / Centre de création industrielle-Centre Georges Pompidou de Paris depuis 2006. Le stylo BIC® Cristal et le briquet BIC® font également partie de la collection permanente du Museum of Modern Art (MOMA) de New-York.

AINSI QU'À L'ART

Source d'inspiration et outil de travail indispensable pour les artistes, les dessinateurs et toutes les personnes créatives, BIC® est depuis toujours lié à la créativité. Aujourd'hui, de nombreux artistes illustrent l'importance de la marque et des produits BIC®.

BIC® soutient et favorise également la créativité et l'art, comme on a pu le voir cette année à Paris avec la première exposition de la collection BIC, qui a eu un énorme impact, tant en nombre de visiteurs qu'en notoriété.

ES> Un poco de historia...

UNA MARCA UNIDA AL DISEÑO

Los productos y la marca BIC® son símbolos reconocidos de diseño atemporal, así como productos icónicos diseñados de forma inteligente que se han ganado el derecho de formar parte de la colección permanente del Museo de Arte Moderno MOMA de Nueva York desde 2001 y del Centro de Diseño Industrial del Georges Pompidou de París desde 2006.

Y TAMBIÉN AL ARTE

Como fuente de inspiración y valiosa herramienta de trabajo para los artistas, diseñadores y las personas creativas de todo tipo, BIC® siempre ha estado ligada a la creatividad. Muchos de los artistas de hoy en día han mostrado su respeto y afecto por la marca.

BIC® también apoya la creatividad y el arte, como muestra la exposición en París de la primera colección de arte BIC, muy popular entre visitantes y críticos.

DE> Ein Stück Geschichte...

EINE MIT DESIGN VERBUNDENE MARKE

BIC®-Produkte und die Marke BIC® sind nicht nur anerkannte Symbole für zeitloses Design, sondern auch ikonenhafte, geschickt konzipierte Produkte, die sich das Recht erworben haben, seit 2001 Teil der ständigen Sammlung des Museum Of Modern ART (MOMA) in New York und seit 2006 des Industriedesign-Zentrums Georges Pompidou in Paris zu sein.

UND AUCH MIT DER KUNST

Als Quelle der Inspiration und nützliches Arbeitsmittel für Künstler, Designer und kreative Menschen jeglicher Art ist BIC® schon immer mit der Kreativität verbunden. Zahlreiche Gegenwartskünstler haben ihren Respekt und ihre Zuneigung gegenüber der Marke BIC® zum Ausdruck gebracht.

BIC® bietet auch Unterstützung für Kreativität und Kunst, wie die Ausstellung der ersten BIC-Kunstsammlung in Paris gezeigt hat, die von Besuchern und Kritikern hervorragend angenommen wurde.

IT> Un po' di storia...

UN MARCHIO LEGATO AL DESIGN

I prodotti e il marchio BIC® sono rinomati simboli del design senza tempo. Iconici e distinti da un design elegante, i prodotti BIC® si sono guadagnati il diritto di far parte dal 2001 della collezione permanente del Museum Of Modern ART (MOMA) di New York e del Centre de création industrielle Georges Pompidou di Parigi dal 2006.

E ANCHE ALL'ARTE

Fonte di ispirazione e prezioso strumento di lavoro per artisti, designer e creativi di ogni tipo, da sempre BIC® ha avuto legami con la creatività.

Molti degli artisti di oggi hanno manifestato rispetto e affetto per il marchio BIC®.

BIC® sostiene anche la creatività e l'arte, come dimostra la mostra a Parigi della prima collezione d'arte BIC, ampiamente apprezzata da visitatori e critici.

A BRAND LINKED TO DESIGN



BIC® products and the BIC® brand are recognized symbols of timeless design, as well as iconic, smartly designed products that have earned the right to form part of the permanent collection of the Museum Of Modern ART (MOMA) from New York since 2001 & for Industrial Design Centre Georges Pompidou from Paris since 2006.

AND ALSO TO ART

As a source of inspiration and a valuable working tool for artists, designers and creative people of all kinds, BIC® has always had ties with creativity. Many of today's artists have shown their respect and affection for the BIC® brand.



MAMADOU CISSÉ
SANS TITRE, 21 JUILLET 2014



VINCENT SERVOZ
UNTITLED - CIRCLE N°4



TSE & TSE
600 BIC® PENS



BIC® also provides support for creativity and art, as shown by the exhibition in Paris of the first BIC art collection, which was very popular with visitors and critics.



FR> Brand

LA MARQUE BIC® EST RECONNUE PAR 9 PERSONNES SUR 10

QU'EST-CE BIC A DE SI SPÉCIAL ?

- ÉTHIQUE, RESPONSABILITÉ, TRAVAIL D'ÉQUIPE, SIMPLICITÉ, INGÉNUIOSITÉ
- UNE VISION DEPUIS 60 ANS
- DES VALEURS FORTES
- UNE PHILOSOPHIE
- PROPOSER DES PRODUITS DE QUALITÉ, SIMPLES, INVENTIFS ET FIABLES, POUR TOUS, PARTOUT DANS LE MONDE
- HONORER LE PASSÉ E INVENTER LE FUTUR

ES> Brand

LA MARCA BIC® ES RECONOCIDA POR 9 DE CADA 10 PERSONAS

¿QUÉ TIENE DE ESPECIAL BIC®?

- ÉTICA, RESPONSABILIDAD, TRABAJO EN EQUIPO, SIMPLICIDAD, INGENIO
- 60 AÑOS DE VISIÓN
- FUERTES VALORES
- UNA FILOSOFÍA
- OFRECER OPCIONES SENCILLAS, INGENIOSAS Y FIABLES PARA TODOS, EN CUALQUIER MOMENTO Y LUGAR
- HONRAR EL PASADO E INVENTAR EL FUTURO

DE> Brand

9 VON 10 BEFRAGTE KENNEN DIE MARKE BIC®

WAS IST SO BESONDERS AN BIC?

- ETHIK VERANTWORTUNG TEAMWORK EINFACHHEIT EINFALLSREICHTUM
- EINE 60 JAHRE ALTE VISION
- STARKE WERTE
- EINE PHILOSOPHIE
- QUALITATIV HOCHWERTIGE PRODUKTE BIETEN
- DIE VERGANGENHEIT EHREN, DIE ZUKUNFT ERFINDEN

IT> Brand

IL MARCHIO BIC® È RICONOSCIUTO DA 9 PERSONE SU 10

COS'HA DI COSÌ TANTO SPECIALE BIC?

- ETICA, RESPONSABILITÀ, LAVORO DI SQUADRA, SEMPLICITÀ, INGEGNO
- 60 ANNI DI VISIONE
- FORTI VALORI
- UNA FILOSOFIA
- OFFRIRE SCELTE SEMPLICI, INGEGNOSE E AFFIDABILI PER TUTTI, IN OGNI LUOGO E MOMENTO
- ONORARE IL PASSATO E INVENTARE IL FUTURO





**THE BIC® BRAND IS RECOGNISED
BY 9 OUT OF 10 PEOPLE**



FR> Brand

VENTES NETTES EN 2017 PAR CATÉGORIE

32 MILLIONS

Produits du groupe BIC achetés chaque jour⁽¹⁾ dans le monde entier

BASE 365 JOURS

20,3 MILLIONS

Articles de papeterie achetés chaque jour dans le monde entier

7,3 MILLIONS

Rasoirs achetés chaque jour dans le monde entier

4,4 MILLIONS

Briquets achetés chaque jour dans le monde entier

ES> Brand

VENTAS NETAS 2017 POR CATEGORÍA

32 MILLONES

Productos del Grupo BIC comprados cada día ⁽¹⁾ en todo el mundo

BASE 365 DÍAS

20,3 MILLONES

Productos de Escritura comprados cada día en todo el mundo

7,3 MILLONES

Maquinillas compradas cada día en todo en mundo

4,4 MILLONES

Encendedores comprados cada día en todo el mundo

DE> Brand

2017 NETTOUMSATZERLÖSE NACH KATEGORIE

32 MILLIONEN

Produkte der BIC Group werden weltweit jeden Tag gekauft ⁽¹⁾

GRUNDLAGE 365 TAGE

20,3 MILLIONEN

Schreibwaren werden weltweit jeden Tag gekauft

7,3 MILLIONEN

Rasierer werden weltweit jeden Tag gekauft

4,4 MILLIONEN

Feuerzeuge werden weltweit jeden Tag gekauft

IT> Brand

VENDITE NETTE 2017 PER CATEGORIA

32 MILIONI

Prodotti del Gruppo BIC acquistati ogni giorno⁽¹⁾ a livello mondiale

BASE 365 GIORNI

20,3 MILIONI

Articoli di cancelleria acquistati ogni giorno a livello mondiale

7,3 MILIONI

Rasoi acquistati ogni giorno a livello mondiale

4,4 MILIONI

Accendini acquistati ogni giorno a livello mondiale



2017 NET SALES
BY CATEGORY

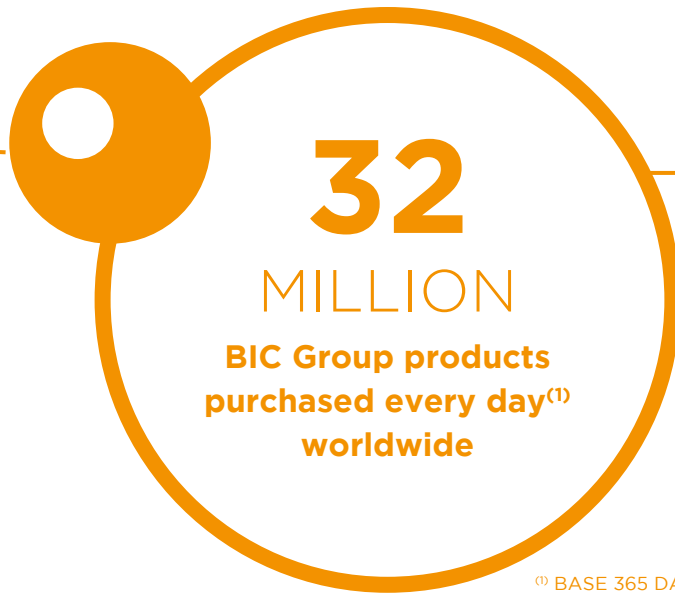

FR> Sustainable development
NOUS SAVONS FAIRE LA DIFFÉRENCE ET NOUS SAVONS
QUE LA FAÇON DONT NOUS FABRIQUONS ET DISTRIBUONS
NOS PRODUITS EST IMPORTANTE

DES PRODUITS ABORBABLES FABRIQUÉS POUR DURER.
Depuis le début, BIC® a toujours fabriqué ses produits avec le "juste nécessaire", laissant de côté le superflu. Nos priorités : économiser les matières, innover, et saisir les opportunités offertes par l'économie circulaire (destinés à réduire les déchets), tout en continuant à offrir des produits abordables, facilement disponibles et modernes.

LÉGER ET... DURABLE, ÉCONOMIQUE

REDUCTION DE NOTRE EMPREINTE ENVIRONNEMENTALE.
BIC aspire constamment à réduire l'empreinte environnementale de ses activités, agissant sur tous les fronts : systèmes de management environnemental, optimisation des consommations d'eau et d'énergie, réduction et recyclage des déchets, réduction des émissions de gaz à effet de serre, et plus encore.

USINES, TRANSPORT, PACKAGING

- 24%: Réduction de la consommation d'énergie par tonne de production dans les 10 dernières années.
- 85%: Réduction de la consommation d'eau par tonne de production dans les 10 dernières années.
- 90,3% de nos cartons d'emballages viennent d'origines certifiées et/ou recyclées.

UNIR LES PERSONNES AUTOUR DE VALEURS CLÉS.
ENGAGEMENT POUR L'ÉDUCATION

Pour en savoir plus sur le développement durable chez BIC® :
bicworld.com/en/our-commitments/overview

DE> Sustainable development
WIR SIND ÜBERZEUGT, DASS WIR ETWAS BEWEGEN KÖNNEN
UND WIR TUN ES IN DER ART, WIE WIR UNSERE PRODUKTE
HERSTELLEN UND IN UNSEREM UNTERNEHMERISCHEN HANDELN

PRODUKTE, DIE ERSCHWINGLICH UND LANGLEBIG SIND.
Bereits von Anfang an hat BIC® seine Produkte immer mit „dem Nötigsten“ hergestellt und alles Überflüssige weggelassen. Unsere Prioritäten: Material einsparen, Innovationen entwickeln, Chancen in der Kreislaufwirtschaft ergreifen (mit dem Ziel Abfall zu reduzieren), und gleichzeitig erschwingliche, jederzeit verfügbare und moderne Produkte anzubieten.

LEICHTGEWICHTIG &... LANGLEBIG, ERSCHWINGLICH

UNSEREN ÖKOLOGISCHEN FUSSABDRUCK REDUZIEREN.
BIC® strebt kontinuierlich danach, den ökologischen Fußabdruck seines Handelns zu reduzieren und arbeitet dabei in alle Richtungen: Umweltmanagementsystem, Optimierung des Wasser- und Energieverbrauchs, Reduzierung und Recycling von Abfall, Reduktion der Treibhausgasemissionen und weitere.

FABRIKEN, TRANSPORT, VERPACKUNG

- 24 %: Reduzierung des Energieverbrauchs pro Tonne Produktionsmenge in den letzten 10 Jahren.
- 85 %: Reduzierung des Wasserkonsums pro Tonne Produktionsmenge in den letzten 10 Jahren.
- 90,3 % der Kartonverpackungen kommen aus zertifizierten und/oder Recycling-Quellen.

UNSERE MITARBEITER EINIGEN SICH AUF GRUNDWERTE.
ZUR WEITERBILDUNG VERPFLICHTET

Erfahren Sie mehr über Nachhaltigkeitsentwicklung:
bicworld.com/en/our-commitments/overview

ES> Sustainable development
APOSTAMOS POR MARCAR LA DIFERENCIA Y SABEMOS
CÓMO DESARROLLAR NUESTROS PRODUCTOS Y CONDUCIR
NUESTRO NEGOCIO

PRODUCTOS ASEQUIBLES HECHOS PARA DURAR.
Desde el comienzo, BIC® siempre ha fabricado sus productos con "sólo lo necesario", dejando de lado todo lo superfluo. Nuestras prioridades: ahorrar materiales, innovar y aprovechar las oportunidades que ofrece la economía circular (destinada a reducir los residuos), mientras continuamos ofreciendo productos asequibles, fácilmente disponibles y modernos.

LIGERO Y... DE LARGA DURACIÓN, ASEQUIBLE

REDUCIENDO NUESTRA HUELLA AMBIENTAL.
BIC® se esfuerza constantemente en reducir su huella ambiental en sus operaciones, actuando en todos los frentes: sistemas de gestión ambiental, optimización del consumo de agua y energía, reducción y reciclaje de residuos, reducción de emisiones de gases de efecto invernadero, y más.

FÁBRICAS, TRANSPORTE, EMBALAJE

- 24%: reducción en el consumo de energía por tonelada de producción en los últimos 10 años.
- 85%: reducción en el consumo de agua por tonelada de producción en los últimos 10 años.
- 90,3% de envases de cartón proviene de fuentes certificadas y/o recicladas.

UNIENDO A NUESTRAS PERSONAS ALREDEDOR DE VALORES CLAVE.
COMPROMISO CON LA EDUCACIÓN

Más información sobre Desarrollo Sostenible en:
bicworld.com/en/our-commitments/overview

IT> Sustainable development
NOI CREDIAMO NEL FARE LA DIFFERENZA E SAPIAMO COME
REALIZZARE I NOSTRI PRODOTTI E CONDURRE I NOSTRI AFFARI

PRODOTTI ECONOMICI FATTI PER DURARE.
Fin dal principio, BIC® ha sempre realizzato i suoi prodotti "solo con il necessario", tralasciando tutto il superfluo. Le nostre priorità: risparmiare materiale, innovare e cogliere l'opportunità offerta dall'economia circolare (destinata a ridurre i rifiuti), nel mentre continuare ad offrire prodotti economici, prontamente disponibili e moderni.

LEGGERO E...DI LUNGA DURATA, ECONOMICO

RIDUCENDO IL NOSTRO IMPATTO AMBIENTALE.
BIC è costantemente impegnata a ridurre l'impatto ambientale delle sue operazioni, agendo su ogni fronte: sistemi di gestione ambientali, ottimizzazione dei consumi di acqua ed energia, riduzione e riciclo dei rifiuti, diminuzione delle emissioni di gas a effetto serra, e oltre.

FABBRICHE, TRASPORTO, IMBALLAGGIO

- 24%: Riduzione del consumo di energia per tonnellata di produzione negli ultimi 10 anni.
- 85%: Riduzione nel consumo di acqua per tonnellata di produzione negli ultimi 10 anni.
- 90,3% di cartone per imballaggio proviene da fonti certificate e/o riciclate.

UNENDO LE NOSTRE PERSONE ATTORNO AI VALORI CHIAVE.
IMPEGNO ALL'ISTRUZIONE

Maggiori informazioni riguardo allo Sviluppo Sostenibile:
bicworld.com/en/our-commitments/overview





sustainable development

WE BELIEVE IN MAKING A DIFFERENCE

AND WE KNOW THAT HOW WE MAKE OUR PRODUCTS AND CONDUCT OUR BUSINESS MATTERS

AFFORDABLE PRODUCTS MADE TO LAST.

From the beginning, BIC® has always made its products with “just what’s necessary,” leaving out anything superfluous. Our priorities: save materials, innovate, and seize opportunities offered by the circular economy (aimed at reducing waste), while continuing to offer affordable, readily available, and modern products.



LIGHTWEIGHT &...



... LONG LASTING



AFFORDABLE

REDUCING OUR ENVIRONMENTAL FOOTPRINT.

BIC® is constantly striving to reduce the environmental footprint of its operations, acting on every front: environmental management systems, optimisation of water and energy consumption, reduction and recycling of waste, reducing greenhouse gas emissions, and more.



FACTORIES



TRANSPORTATION



PACKAGING



24%

Reduction in energy consumption per ton of production in the past 10 years.



85%

Reduction in water consumption per ton of production in the past 10 years.



90,3%

Of cardboard packaging comes from certified and/or recycled sources.

UNITING OUR PEOPLE AROUND KEY VALUES



COMMITMENT TO EDUCATION



Learn more about Sustainable Development:
bicworld.com/en/our-commitments/overview

FR> Sustainable development
ÉCRIRE LE FUTUR ENSEMBLE
UNE NOUVELLE AMBITION POUR 2025

Notre vision s'exprime dans le slogan « Écrire le futur ensemble », et englobe cinq engagements ambitieux alignés sur la stratégie du groupe :

#1 Promouvoir l'innovation responsable dans les produits BIC® :
D'ici 2025, l'empreinte écologique et/ou sociale des produits BIC® sera améliorée..

#2 Agir contre le réchauffement climatique :
D'ici 2025, BIC utilisera 80 % d'électricité renouvelable.

#3 S'engager pour un environnement de travail sûr :
D'ici 2025, BIC vise zéro accidents pour toutes ses opérations.

#4 Impliquer proactivement les fournisseurs :
D'ici 2025, BIC travaillera de manière responsable avec ses fournisseurs stratégiques pour s'assurer un approvisionnement plus sécurisé, innovant et efficace.

#5 Améliorer des vies grâce à l'éducation :
D'ici 2025, BIC améliorera les conditions d'apprentissage pour 250 millions d'enfants du monde entier.

ES> Sustainable development
ESCRIBIENDO EL FUTURO JUNTOS
UNA NUEVA AMBICIÓN PARA 2025

Nuestra visión queda plasmada en el lema «Escribiendo el futuro juntos», que engloba cinco compromisos ambiciosos en línea con la estrategia del Grupo:

#1 Fomentar la innovación sostenible en los productos BIC®:
De aquí a 2025, se prevé mejorar la huella de los productos BIC® en el medio ambiente y la sociedad.

#2 Actuar contra el cambio climático:
De aquí a 2025, BIC utilizará un 80 % de electricidad renovable.

#3 Comprometerse con un entorno de trabajo seguro:
De aquí a 2025, BIC pretende conseguir que no se produzca ningún accidente en su cadena productiva.

#4 Implicar a los proveedores de forma proactiva:
De aquí a 2025, BIC trabajará de manera responsable con sus proveedores estratégicos para garantizar un abastecimiento lo más seguro, innovador y eficiente posible.

#5 Mejorar las vidas mediante la educación:
De aquí a 2025, BIC mejorará las condiciones de aprendizaje de 250 millones de niños en todo el mundo.

DE> Sustainable development
ZUSAMMEN DIE ZUKUNFT SCHREIBEN
EIN NEUES ZIEL FÜR 2025

Unsere Vision kommt in unserer Signatur "Zusammen die Zukunft schreiben" zum Ausdruck. Dazu gehören fünf ehrgeizige Verpflichtungen, die mit der Strategie der Gruppe auf einer Linie liegen:

#1 Förderung nachhaltiger Entwicklung bei BIC®-Produkten:
Bis 2025 werden ökologischer und/ oder gesellschaftlicher Fußabdruck der BIC®-Produkte verbessert worden sein.

#2 Kampf gegen den Klimawandel:
Bis 2025 wird BIC zu 80 % regenerativen Strom einsetzen.

#3 Verpflichtung zu einer sicheren Arbeitsumgebung:
Bis 2025 strebt BIC null Unfälle in allen Betrieben an.

#4 Lieferanten proaktiv involvieren:
Bis 2025 wird BIC mit den strategischen Lieferanten verantwortungsvoll zusammenarbeiten, um eine so sichere, innovative und effiziente Beschaffung wie möglich sicherzustellen.

#5 Durch Bildung Leben verbessern:
Bis 2025 wird BIC die Lernbedingungen von 250 Millionen Kindern weltweit verbessern.

IT> Sustainable development
SCRIVERE IL FUTURO INSIEME
UNA NUOVA AMBIZIONE PER IL 2025

La nostra visione è espressa nella firma "Scrivere il futuro insieme", che comprende cinque impegni ambiziosi in linea con la strategia del Gruppo:

#1 Promuovere l'innovazione sostenibile nei prodotti BIC®:
Entro il 2025, l'impronta ambientale e/o sociale dei prodotti BIC® sarà migliorata.

#2 Agire contro il cambiamento climatico:
Entro il 2025, BIC utilizzerà l'80% di elettricità rinnovabile.

#3 Impegnarsi per un ambiente di lavoro sicuro:
Entro il 2025, BIC mira ad azzerare gli incidenti in tutte le operazioni di processo.

#4 Coinvolgere proattivamente i fornitori:
Entro il 2025, BIC lavorerà in modo responsabile con i suoi fornitori strategici per garantire forniture più sicure, innovative ed efficienti.

#5 Migliorare la vita attraverso l'educazione:
Entro il 2025, BIC migliorerà le condizioni di apprendimento di 250 milioni di bambini in tutto il mondo.





WRITING THE FUTURE TOGETHER

A NEW AMBITION FOR 2025

Our vision is expressed in the signature **“Writing the Future, Together”**, encompassing five ambitious commitments in line with the Group’s strategy:

#1 Fostering sustainable innovation in BIC® products:

By 2025, the environmental and/or societal footprint of BIC® products will be improved.

#2 Acting against climate change:

By 2025, BIC Group will use 80% renewable electricity.

#3 Committing to a safe work environment:

By 2025, BIC Group aims for zero accidents across all operations.

#4 Proactively involving suppliers:

By 2025, BIC Group will work responsibly with its strategic suppliers to ensure the most secure, innovative and efficient sourcing.

#5 Improving lives through education:

By 2025, BIC Group will improve learning conditions for 250 million children globally.



FR> Sustainable development

UBICUITY™ : UN MODÈLE D'ÉCONOMIE CIRCULAIRE UNIQUE

En partenariat avec Plas Eco, BIC présente Ubiuity™, la première gamme de meubles d'extérieur fabriqués à partir de stylos recyclés.

TROIS ÉTAPES:

1. VOUS COLLECTEZ
2. NOUS RECYCLONS
3. NOUS TRANSFORMONS

DE> Sustainable development

**UBICUITY™: EIN EINZIGARTIGES
KREISLAUFWIRTSCHAFTSMODELL**

In Partnerschaft mit Plas Eco stellt BIC Ubiuity™ vor, das erste Outdoormöbelsortiment aus recycelten Stiften.

DREI SCHRITTE:

1. SIE SAMMELN
2. WIR RECYCELN
3. WIR WANDELN UM

ES> Sustainable development

UBICUITY™: UN MODELO ECONÓMICO CIRCULAR ÚNICO

En colaboración con Plas Eco, BIC presenta Ubiuity™, la primera gama de muebles de exterior fabricada con bolígrafos reciclados.

TRES FASES:

1. TÚ HACES LA RECOGIDA SELECTIVA
2. NOSOTROS RECICLAMOS LOS BOLÍGRAFOS
3. NOSOTROS LOS TRANSFORMAMOS

IT> Sustainable development

UBICUITY™: UN MODELLO ECONOMICO CIRCOLARE UNICO

In collaborazione con Plas Eco, BIC presenta Ubiuity™, la prima gamma di arredamento per esterni realizzata con penne riciclate.

TRE FASI:

1. TU RACCOGLI
2. NOI RICICLIAMO
3. NOI TRASFORMIAMO





sustainable development

UBICUITY™: A UNIQUE CIRCULAR ECONOMY MODEL

In partnership with Plas Eco, BIC® presents Ubicuity™, the first range of outdoor furniture made from recycled pen and other stationery products.



UBICUITY™

THREE STEPS:



FR> Sustainable development RESPONSABILITÉ SOCIALE D'ENTREPRISE

NOS PRIX

DEUX ANNÉES DE SUITE

- 2017 : 1ER PRIX EXCELLENCE ÉCONOMIQUE / 1ER PRIX PRODUIT DURABLE
- 2018 : 1ER PRIX INITIATIVE SOCIALE / 3ÈME PRIX INITIATIVE ENVIRONNEMENTALE

Considéré par Intertek comme conforme aux exigences de :
ÉVALUATION DES CONDITIONS DE TRAVAIL
Prix d'excellence

NOS CERTIFICATIONS

BIC s'est vu décerner un niveau de reconnaissance GOLD par EcoVadis.

CERTIFIÉS PAR L'AUDIT SMETA 4-PILERS

Nos produits certifiés NF :

- BIC® 4 Colours et BIC® 4 Colours Fine
- BIC® Atlantis® et BIC® Atlantis® Clear
- BIC® Matic® Ecolutions®
- BIC® Evolution® Ecolutions®

En juin 2018, BIC GRAPHIC EUROPE a renouvelé avec succès l'audit social Coca-Cola avec un score de 0 non-conformités. Ce résultat permet de renforcer notre relation commerciale avec Coca-Cola et d'autres membres du forum AIM PROGRESS (www.aim-progress.com), et fait toute la différence au sein de l'industrie des produits promotionnels. Les entreprises les plus importantes reconnaissent les résultats de notre audit !

BIC Graphic Europe est un membre officiel de la famille du Pacte mondial des Nations Unies, la plus importante initiative de durabilité des entreprises au monde.

DE> Sustainable development SOZIALE VERANTWORTUNG DES UNTERNEHMENS

UNSERE PREISE

ZWEI JAHRE NACHEINANDER

- 2017: GEWINNER 1. PLATZ WIRTSCHAFTLICHE EXZELLENZ / GEWINNER 1. PLATZ NACHHALTIGES PRODUKT
- 2018: GEWINNER 1. PLATZ SOZIALE INITIATIVE / GEWINNER 3. PLATZ UMWELTINITIATIVE

Erfüllt gemäß der Bewertung von Intertek die Anforderungen gemäß:
BEWERTUNG DER BEDINGUNGEN AM ARBEITSPLATZ
Leistungspreis

UNSERE ZERTIFIZIERUNGEN

Wurde von EcoVadis mit dem GOLD-Level ausgezeichnet.

ZERTIFIZIERT GEMÄSS SMETA 4-SÄULEN

Unsere NF-zertifizierten Produkte:

- BIC® 4 Colours & BIC® 4 Colours Fine
- BIC® Atlantis® & BIC® Atlantis® Clear
- BIC® Matic® Ecolutions®
- BIC® Evolution® Ecolutions®

Im Juni 2018 erneuerte BIC GRAPHIC EUROPE erfolgreich das soziale Audit von Coca-Cola mit einem Ergebnis von 0 Nichtkonformitäten. So können wir unsere Geschäftsbeziehung mit der Coca-Cola-Gruppe und anderen Mitgliedern des AIM-PROGRESS-Forum (www.aim-progress.com) stärken und das unterscheidet uns von anderen in der Werbeartikelbranche. Die wichtigsten Unternehmen erkennen unser Audit an!

BIC Graphic Europe ist offiziell Teil der Familie des UN Global Compact - der weltweit größten Initiative für Nachhaltigkeit von Unternehmen.

ES> Sustainable development RESPONSABILIDAD SOCIAL CORPORATIVA

NUESTROS PREMIOS

DURANTE DOS AÑOS CONSECUTIVOS

- 2017: GANADOR DEL 1.er PUESTO EN EXCELENCIA ECONÓMICA / GANADOR DEL 1.er PUESTO EN PRODUCTOS SOSTENIBLES
- 2018: GANADOR DEL 1.er PUESTO EN INICIATIVA SOCIAL / GANADOR DEL 3.er PUESTO EN INICIATIVA MEDIOAMBIENTAL

BIC ha recibido el asesoramiento de Intertek para cumplir los requisitos de: EVALUACIÓN DE CONDICIONES LABORALES
Certificado de conformidad

NUESTRAS CERTIFICACIONES

EcoVadis nos ha concedido la medalla de oro.

CERTIFICADO POR LA AUDITORÍA SMETA DE 4 PILARES

Nuestros productos certificados por NF:

- BIC® 4 Colours y BIC® 4 Colours Fine
- BIC® Atlantis® y BIC® Atlantis® Clear
- BIC® Matic® Ecolutions®
- BIC® Evolution® Ecolutions®

En junio de 2018, BIC GRAPHIC EUROPE volvió a superar con éxito la auditoría social de Coca-Cola con un resultado de 0 no conformidades. Esta es una de las formas de reforzar nuestra relación comercial con el Grupo Coca-Cola y otros miembros del foro AIM-PROGRESS (www.aim-progress.com). Además, marca la diferencia en el sector de los productos promocionales. ¡Las empresas más importantes reconocen nuestra auditoría!

BIC Graphic Europe forma parte, oficialmente, de la familia del Pacto Mundial de Naciones Unidas, la mayor iniciativa mundial sobre sostenibilidad corporativa.

IT> Sustainable development RESPONSABILITÀ SOCIALE AZIENDALE

I NOSTRI PREMI

PER DUE ANNI DI FILA

- 2017: 1° POSTO VINCITORE DELL'ECCELLENZA ECONOMICA / 1° POSTO VINCITORE DEL PRODOTTO SOSTENIBILE
- 2018: 1° POSTO VINCITORE DELL'INIZIATIVA SOCIALE / 3° POSTO VINCITORE DELL'INIZIATIVA AMBIENTALE

BIC è stata valutata da Intertek come conforme ai requisiti di:
VALUTAZIONE DELLE CONDIZIONI DI LAVORO
Achievement Award

LE NOSTRE CERTIFICAZIONI

BIC è stata premiata con il "GOLD Recognition Level" da EcoVadis.

CERTIFICAZIONE SMETA 4-PILLAR

I nostri prodotti certificati NF:

- BIC® 4 Colours e BIC® 4 Colours Fine
- BIC® Atlantis® e BIC® Atlantis® Clear
- BIC® Matic® Ecolutions®
- BIC® Evolution® Ecolutions®

Nel mese di giugno 2018, BIC GRAPHIC EUROPE ha rinnovato con successo l'audit sociale Coca-Cola con un punteggio di 0 non conformità. Questo è un modo per rafforzare i nostri rapporti commerciali con il Gruppo Coca-Cola e altri membri del forum AIM-PROGRESS (www.aim-progress.com), facendo la differenza nel settore dei prodotti promozionali. Le aziende più importanti riconoscono il nostro audit!

BIC Graphic Europe è ufficialmente parte della famiglia Global Compact delle Nazioni Unite, la più grande iniziativa di sostenibilità aziendale del mondo.



CORPORATE SOCIAL RESPONSIBILITY



OUR AWARDS

FOR TWO YEARS IN A ROW



2017

1ST PLACE WINNER
ECONOMIC EXCELLENCE
1ST PLACE WINNER
SUSTAINABLE PRODUCT



2018

1ST PLACE WINNER
SOCIAL INITIATIVE
3RD PLACE WINNER
ENVIRONMENT INITIATIVE



**WORKPLACE
CONDITIONS
ASSESSMENT**

Has been assessed by Intertek as conforming to the requirements of:

Workplace Conditions Assessment

Achievement Award

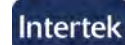

OUR CERTIFICATIONS



Integrated Management System Certifications for the Tarragona facilities from Lloyd's Register.

ISO 9001 - ISO 14001



Our NF certified products:

- BIC® 4 Colours & BIC® 4 Colours Fine
- BIC® Atlantis® & BIC® Atlantis® Clear
- BIC® Matic® Ecolutions®
- BIC® Evolution® Ecolutions®



has been granted a

GOLD
Recognition
Level by

ecovadis



In June 2018, BIC GRAPHIC EUROPE successfully renewed the Coca-Cola social audit with a score of 0 non-conformities. This is a way to reinforce our business relationships with Coca-Cola Group and other members of the AIM-PROGRESS forum (www.aim-progress.com) and it makes the difference in the promotional product industry.
The most important companies recognize our audit!



- Environmental
- Business Ethics
- Health & Safety
- Labour



SMETA 4-PILLAR CERTIFIED



**United Nations
Global Compact**

BIC Graphic Europe is officially part of the UN Global Compact family – **the world's largest corporate sustainability initiative.**

FR> BIC® and Education

L'éducation, un engagement à long terme du groupe BIC

Depuis 1950, BIC a toujours encouragé l'éducation et aidé les enfants à réussir leur éducation en offrant de meilleures conditions d'apprentissage et en faisant la promotion de l'écriture manuelle et de ses avantages.

Pour aller encore plus loin, BIC a lancé son Programme de Développement Durable à l'horizon 2025 dont l'éducation constitue l'un des piliers, avec l'objectif ambitieux d'améliorer les conditions d'apprentissage pour 250 millions d'enfants dans le monde d'ici 2025.

Pour soutenir cet objectif et cet engagement, BIC a organisé sa première Semaine Mondiale de l'Éducation en octobre 2018.

Pendant la Semaine Mondiale de l'Éducation BIC, les membres de nos équipes dans 40 pays et sur 63 sites BIC® du monde entier ont eu la possibilité de consacrer une journée de travail à des actions permettant d'améliorer les conditions d'apprentissage des enfants et des élèves de leur communauté locale, et de se mobiliser pour apporter un changement durable, par l'intermédiaire d'actions concrètes allant du soutien scolaire (avec les devoirs) à la réhabilitation de locaux.

DE> BIC® and Education

Bildung, ein seit langem bestehendes Engagement des BIC-Konzerns

Seit 1950 hat BIC Bildung immer gefördert und den Lernerfolg von Kindern durch die Schaffung besserer Lernbedingungen und durch die Förderung des Schreibens mit der Hand und dessen Vorteilen unterstützt.

Mit dem Wunsch, noch mehr zu leisten, hat BIC das Programm für nachhaltige Entwicklung 2025 ins Leben gerufen, in dem Bildung eine wichtige Säule ist. Wir haben uns das ehrgeizige Ziel gesetzt, bis 2025 die Lernbedingungen von 250 Millionen Kindern weltweit zu verbessern.

Zur Unterstützung dieses Ziels und dieser Verpflichtung hat BIC im Oktober 2018 die erste Weltbildungswoche, die Global Education Week, gestartet.

Während der BIC Global Education Week haben unsere BIC-Teammitglieder in 40 Ländern und an 63 BIC®-Standorten freiwillig bis zu einen Arbeitstag lang geholfen, die Lernbedingungen für Schüler in ihren lokalen Gemeinschaften zu verbessern. So haben sie ihren Teil dazu beigetragen, dauerhaft etwas zu bewirken. Das geschah durch vielgestaltige sinnvolle Aktionen, die von der Unterstützung von Kindern bei den Hausaufgaben bis zur kompletten Renovierung von Schulen reichten.

ES> BIC® and Education

La educación, un consolidado compromiso del Grupo BIC

Desde 1950, BIC siempre ha promovido la educación y ha ayudado a los niños en su aprendizaje ofreciéndoles mejores condiciones de estudio y fomentando la escritura a mano y sus beneficios.

Con la voluntad de llegar aún más lejos, BIC ha lanzado su programa de desarrollo sostenible para 2025, en el que la educación es un pilar esencial, con el objetivo ambicioso de mejorar las condiciones de aprendizaje de 250 millones de niños en todo el mundo de aquí a 2025.

Para respaldar su objetivo y su compromiso, BIC organizó en octubre de 2018 la primera Semana Mundial de la Educación.

Durante la Semana Mundial de la Educación de BIC, los miembros del equipo de 40 países y de más de 63 plantas de BIC® participaron como voluntarios durante una jornada de trabajo para ayudar a mejorar las condiciones de aprendizaje de los niños y estudiantes de sus comunidades, aportando su granito de arena para marcar una diferencia duradera, mediante varias acciones significativas, que van desde ayudar a los niños con los deberes hasta reformar escuelas completas.

IT> BIC® and Education

Istruzione, un impegno a lungo termine del Gruppo BIC

Dal 1950, BIC ha promosso l'istruzione e aiutato i bambini nella formazione fornendo loro migliori condizioni di apprendimento e sostenendo la promozione della scrittura a mano e dei suoi vantaggi.

Con il desiderio di andare oltre, BIC ha lanciato il suo programma di sviluppo sostenibile 2025 in cui l'istruzione è un pilastro fondamentale, con l'ambizioso obiettivo di migliorare le condizioni di apprendimento per 250 milioni di bambini in tutto il mondo entro il 2025.

A sostegno di questo obiettivo e impegno, nell'ottobre 2018 BIC ha lanciato la sua prima Settimana Mondiale dell'Istruzione.

Durante la Settimana Mondiale dell'Istruzione BIC, i membri del nostro team in 40 paesi e in 63 siti BIC® nel mondo hanno dedicato volontariamente fino a una giornata lavorativa per contribuire a migliorare le condizioni di apprendimento di bambini e studenti all'interno delle loro comunità locali, nell'obiettivo di fare una differenza duratura, con varie azioni significative che vanno dal supporto ai bambini con i compiti al completamento dei lavori di ristrutturazione delle scuole.

GLOBAL EDUCATION WEEK



EDUCATION, A LONG-STANDING COMMITMENT OF THE BIC® GROUP

Since 1950, BIC® has always been promoting Education and helping children succeed in learning by providing better conditions of learning and through the promotion of handwriting and its benefits.

With the desire to go further, BIC® has launched its 2025 sustainable development program in which Education is a key pillar, with an ambitious goal of improving learning conditions for 250 million children globally by 2025.

In support of this objective and commitment, BIC® launched in October 2018 its first Global Education Week.

During the BIC Global Education Week, our team members in 40 countries and across 63 BIC® sites around the world volunteered up to a day of work to help to improve learning conditions for children and students within their local communities, doing their share to make a lasting difference, with varied meaningful actions ranging from homework support for children to complete school refurbishments.



FR> BIC® and Education

LA FONDATION D'ENTREPRISE BIC

LA FONDATION D'ENTREPRISE BIC A POUR MISSION D'AMÉLIORER L'ACCÈS À L'ÉDUCATION ET D'ASSURER LA QUALITÉ DE L'ENSEIGNEMENT DES ENFANTS ET DE LA JEUNESSE DANS LE MONDE.

SES VOLETS D'ACTION SONT LES SUIVANTS :

- Lutte contre le décrochage scolaire
- Meilleur accès à l'éducation pour les femmes et les filles
- Éducation environnementale

PAR LA PROMOTION DU PARTENARIAT SOCIAL DES ENTREPRENEURS

Nous soutenons actuellement 18 projets dans le monde entier !

Découvrez certains d'entre eux :

- PROMOTION DE LA RÉUSSITE SCOLAIRE » - CROIX-ROUGE ESPAGNE / OÙ? TARRAGONE, (ESPAGNE). Offre aux enfants défavorisés un espace leur permettant de renforcer leurs compétences scolaires, afin de promouvoir le développement personnel et la prise de bonnes habitudes.
- PROGRAMME DE MENTORAT - AFEV / OÙ? BREST, REIMS, BORDEAUX (FRANCE). Des étudiants de l'université servent de mentors à des élèves en risque de décrochage scolaire. Ils les aident à faire leur devoir et offrent un espace de récréation afin de les aider à retrouver le goût des études.
- LE « TERRAIN BUT EN OR » - SPORTS DANS LA VILLE / OÙ? BOBIGNY (FRANCE). Favoriser l'insertion sociale et professionnelle au moyen du sport, en aidant chaque enfant et chaque jeune à acquérir de la confiance en soi et des valeurs essentielles qui leur permettront de réussir leur projet de vie.

Nous soutenons aussi...

- PROJET « RADIO INDIFESA », ONG TERRE DES HOMMES, ITALIE
- CENTRE KIDS ARE KIDS, LE FONDS DE BIENFAISANCE « MOSAIC OF HAPPINESS », (RUSSIE)

DE> BIC® and Education

STIFTUNG BIC CORPORATE FOUNDATION

AUFGABE DER STIFTUNG BIC CORPORATE FOUNDATION IST DIE VERBESSERUNG DES ZUGANGS ZU BILDUNG.

DIE SÄULEN IHRER ARBEIT SIND:

- Kampf gegen Schulabbruch
- Besserer Bildungszugang für Frauen und Mädchen
- Umweltbildung

DURCH DIE FÖRDERUNG SOZIALEN UNTERNEHMERTUMS

Wir unterstützen derzeit 16 Projekte auf der ganzen Welt! Sehen Sie sich einige davon einmal an:

- „SCHULERFOLG“ SPANISCHES ROTES KREUZ / WO? TARRAGONA, SPANIEN. Bietet Kindern, die in prekären sozialen Verhältnissen leben, einen Raum, um ihre schulischen Fähigkeiten zu stärken, ihre persönliche Entwicklung und gesunde Gewohnheiten zu fördern.
- MENTORINGPROGRAMM - AFEV / WO? BREST, REIMS, BORDEAUX, FRANKREICH. Universitätsstudenten betreuen einen Schüler, bei dem das Risiko besteht, dass er die Schule abbricht. Sie helfen bei Schularbeiten und bieten einen Raum für Erholung, der dazu beitragen soll, wieder Interesse an Bildung zu wecken.
- FUSSBALLZENTRUM „TERRAIN BUT EN OR“ - SPORTS DANS LA VILLE / WO? BOBIGNY, FRANKREICH. Aufbau gesellschaftlicher und beruflicher Eingliederung durch Sport. Jedem Kind oder Jugendlichen wird geholfen, Selbstvertrauen und wesentliche Werte zu erwerben, die sie in die Lage versetzen, mit ihrem Lebensprojekt Erfolg zu haben.

Wir unterstützen auch...

- PROJEKT „RADIO INDIFESA“, NGO TERRE DES HOMMES, ITALIEN
- ZENTRUM KINDER, KINDER WOHLTÄTIGKEITS-FONDS „MOSAIC OF HAPPINESS“, RUSSLAND

ES> BIC® and Education

BIC CORPORATE FOUNDATION

LA MISIÓN DE LA FUNDACIÓN BIC ES MEJORAR EL ACCESO A LA EDUCACIÓN.

SUS LÍNEAS DE ACCIÓN SON:

- Luchar contra el abandono escolar
- Facilitar el acceso a la educación a niñas y mujeres
- Fomentar la educación medioambiental

MEDIANTE LA PROMOCIÓN DE LA EMPRENDEDURÍA SOCIAL

Actualmente, respaldamos 16 proyectos en todo el mundo. Estos son algunos de ellos:

- «PROMOCIÓN DEL ÉXITO ESCOLAR» - CRUZ ROJA ESPAÑOLA / ¿DÓNDE? TARRAGONA, ESPAÑA. Con este proyecto, se ofrece a los niños que viven en condiciones sociales precarias un espacio para reforzar su competencias académicas y fomentar su desarrollo personal y hábitos saludables.
- PROGRAMA DE ORIENTACIÓN - AFEV / ¿DÓNDE? BREST - REIMS - BURDEOS, FRANCIA. Los estudiantes universitarios ejercen de mentores con escolares con riesgo de abandonar los estudios. Les ayudan con los deberes y les ofrecen un espacio de ocio que contribuye a que recobren su interés por la educación.
- CENTRO FUTBOLÍSTICO «TERRAIN BUT EN OR» - SPORTS DANS LA VILLE / ¿DÓNDE? BOBIGNY, FRANCIA. Contribuimos a la inserción social y profesional a través del deporte, ayudando a que los niños y los adolescentes ganen confianza en sí mismos e integren valores esenciales que les permitan tener éxito en su proyecto vital.

También ofrecemos nuestro apoyo a...

- PROYECTO «RADIO INDIFESA», ONG TERRE DES HOMMES, ITALIA
- CENTRO KIDS ARE KIDS, ORGANIZACIÓN BENÉFICA «MOSAIC OF HAPPINESS» (RUSIA)

IT> BIC® and Education

LA BIC CORPORATE FOUNDATION

LA MISSIONE DELLA BIC CORPORATE FOUNDATION È MIGLIORARE L'ACCESSO ALL'ISTRUZIONE.

I SUOI PILASTRI DI AZIONE SONO:

- Lotta contro l'abbandono scolastico
- Migliore accesso all'istruzione per donne e ragazze
- Educazione ambientale

TRAMITE LA PROMOZIONE DELL'IMPRENDITORIA SOCIALE

Al momento stiamo sostenendo 16 progetti in tutto il mondo! Dai un'occhiata ad alcuni di questi:

- “SUCCESSO SCOLASTICO” - CROCE ROSSA, SPAGNA / DOVE? TARRAGONA, SPAGNA. Offre ai bambini che vivono in condizioni sociali precarie uno spazio che li aiuti a rafforzare le proprie competenze accademiche, promuovere lo sviluppo personale e le sane abitudini.
- PROGRAMMA DI MENTORING - AFEV / DOVE? BREST - REIMS - BORDEAUX, FRANCIA. Studenti universitari supportano uno studente scolastico a rischio di abbandono della scuola. Offrono il loro supporto tramite il lavoro scolastico e uno spazio ricreativo per aiutarli a recuperare interesse per l'istruzione.
- CENTRO CALCISTICO “TERRAIN BUT EN OR” - SPORTS DANS LA VILLE / DOVE? BOBIGNY, FRANCIA. Creare l'inserimento sociale e professionale attraverso lo sport, aiutando ogni bambino o ragazzo ad acquisire la sicurezza e i valori essenziali che gli consentano di avere successo nel suo progetto di vita.

Inoltre, sosteniamo...

- PROGETTO “RADIO INDIFESA”, ONG TERRE DES HOMMES, ITALIA
- CENTRO “KIDS ARE KIDS”, IL FONDO DI BENEFICENZA “MOSAIC OF HAPPINESS”, RUSSIA.



THE BIC CORPORATE FOUNDATION

THE BIC CORPORATE FOUNDATION'S MISSION IS TO IMPROVE THE ACCESS TO EDUCATION, ALSO ENSURING A QUALITY EDUCATION FOR CHILDREN & YOUTHS AROUND THE WORLD.

ITS PILLARS OF ACTION ARE:

 <p>Fight against school dropout</p>	 <p>Better access to education for women and girls</p>	 <p>Environmental education</p>
EDUCATION		

THROUGH THE PROMOTION OF SOCIAL ENTREPRENEURSHIP

We currently support 16 projects all around the world! Take a look at some of them:



“SCHOOL SUCCESS” RED CROSS SPAIN

WHERE? TARRAGONA, SPAIN
Offers children living in precarious social conditions a space to reinforce their academic competencies, to promote personal development and healthy habits.



MENTORING PROGRAM - AFEV

WHERE? BREST, REIMS, BORDEAUX, FRANCE
University students mentor a school student at risk of school dropout. They help with school work and provide a recreation space to help them regain interest in education.



“GOLDEN GOAL” SOCCER CENTER - SPORTS DANS LA VILLE

WHERE? BOBIGNY, FRANCE
Build-up social and professional insertion through sport, helping each child or youngster to gain self-confidence and essential values that will allow them to succeed in their life project.

We also support...



**PROJECT “RADIO INDIFESA”
NGO TERRE DES HOMMES
ITALY**



**KIDS ARE KIDS CENTER
THE CHARITY FUND
“MOSAIC OF HAPPINESS”
RUSSIA**



FR> Safety & Quality

La qualité et la sécurité ne sont pas seulement des thèmes à la mode. Chez BIC Graphic Europe, elles constituent un actif stratégique et font partie de l'ADN du groupe BIC. 32 millions de produits sont fabriqués chaque jour sur les sites de production BIC. Leur qualité est vérifiée à l'aide de nombreux contrôles qui respectent les réglementations et les exigences nationales et internationales en termes de sécurité. Des employés bien formés, un système de contrôle de la qualité rigoureux et une logique d'amélioration continue de notre équipe de Recherche et Développement garantissent des produits BIC® de qualité élevée.

ARTICLES DE PAPERIE BIC®. 100 % de nos stylos à bille sont fabriqués au moyen d'un processus strictement contrôlé. Parfaitement sphériques, ils sont presque plus durs qu'un diamant. 7250 kilomètres : la longueur des tests d'écriture réalisés en 2015 sur des lots de stylos à bille, stylos à encre gel et rollers.

BRIQUETS BIC®. Un quart de chaque journée de travail d'un opérateur dans un site de production de briquets BIC® est consacré aux contrôles qualité. Les briquets BIC® sont soumis à plus de 50 vérifications automatiques de la qualité et de la sécurité avant de quitter le site de production. Tous les briquets de poche BIC® sont conformes ou dépassent les normes et réglementations internationales.

RASOIRS BIC®. 100 % des lames de rasoir sont inspectées visuellement : contrôles statistiques des dimensions, mesures des angles de coupe, évaluation de la régularité parfaite du tranchant de la lame, etc. 30 contrôles différents pour fabriquer un rasoir à 3, 4 ou 5 lames conforme aux normes de qualité strictes de BIC. Les trois sites de production des célèbres rasoirs BIC ont reçu trois certifications : ISO 9001, ISO 14001 et OHSAS 18001.

IMPRESSION. Nos encres sont conformes aux réglementations européennes. Chaque technique d'impression est validée grâce à 5 tests distincts :

- Test d'adhésion
- Test de résistance aux rayures (ISO 12137:11)
- Test d'abrasion
- Test de résistance
- Test d'exposition à la transpiration par simulation

Chaque commande de produits imprimés passe 4 contrôles distincts :
• Contrôle de l'apparence cosmétique • Contrôle de la couleur imprimée
• Contrôle de l'adhérence de l'impression • Résistance à la détérioration

DE> Safety & Quality

Qualität und Sicherheit sind nicht nur Trendthemen. Bei BIC Graphic Europe sind sie ein strategisches Asset und gehören zur DNA der BIC Group. 32 Millionen Produkte werden in den BIC-Werken täglich hergestellt. Ihre Qualität wird in vielfachen Kontrollen geprüft, die nationale und internationale Sicherheitsvorschriften und Anforderungen einhalten. Gut ausgebildete Mitarbeiter, ein strenges Qualitätskontrollsystem und Fokussierung auf kontinuierliche Verbesserung durch das Forschungs- und Entwicklungsteam stellen sicher, dass BIC®-Produkte höchste Qualität sind.

BIC®-SCHREIBWAREN. 100 % der Kugeln für Kugelschreiber werden in einem streng kontrollierten Prozess hergestellt. Sie sind perfekt kugelförmig und fast härter als ein Diamant. 7.250 Kilometer Die Länge der Schreibtests, die 2015 mit Losen von Kugelschreibern, Gelschreibern und Rollerballs durchgeführt wurden.

BIC®-FEUERZEUGE. Ein Viertel seines Arbeitstags verbringt ein Arbeiter in einem BIC®-Feuerzeugwerk mit Qualitätskontrollen. Jedes BIC®-Feuerzeug durchläuft mehr als 50 automatische Qualitäts- und Sicherheitskontrollen, bevor es das Werk verlässt. Alle BIC®-Taschenfeuerzeuge erfüllen oder sind besser als internationale Standards und regulatorische Anforderungen.

BIC®-RASIERER. 100 % aller Rasierklingen werden durch Sichtkontrolle geprüft: dimensionale Statistikkontrollen, Schärfwinkelmessungen, Beurteilungen der perfekten Glätte der Klingenkante usw. 30 verschiedene Kontrollen, um einen 3-, 4- oder 5-Klingen-Rasierer herzustellen, der den strengen Qualitätsstandards von BIC entspricht. Mehrfach zertifiziert. BICs drei Rasiererproduktionswerke sind dreifach zertifiziert: ISO 9001, ISO 14001 und OHSAS 18001.

DRUCK. Unsere Druckfarben entsprechen den EU-Vorschriften. Alle Aufdrucktechniken werden durch 5 verschiedene Tests validiert:
• Haftungstest • Kratztest (ISO 12137:11)
• Abriebtest • Falltest
• Test mit Einwirkung von künstlichem Schweiß

Jede Druckbestellung durchläuft 4 verschiedene Kontrollen:
• Kontrolle der optischen Erscheinung • Aufdruckfarbkontrolle
• Kontrolle der Haftung des Aufdrucks • Kratzfestigkeit

ES> Safety & Quality

La calidad y la seguridad no son solo temas que están de moda. En BIC Graphic Europe, también son un activo estratégico y forman parte del ADN de los 32 millones de productos que se fabrican a diario en las fábricas de BIC. Su calidad es sometida a múltiples controles que cumplen las normativas y requisitos nacionales e internacionales en materia de seguridad. La buena formación de los empleados, un sistema de control de la calidad riguroso y el enfoque centrado en la mejora continua del equipo de Investigación y Desarrollo garantizan la calidad óptima de los productos BIC®.

PRODUCTOS DE PAPELERÍA BIC®. El 100 % de los bolígrafos se fabrican mediante un proceso altamente controlado. Su punta, totalmente esférica, es casi más dura que el diamante. 7250 km: esa es la longitud de las pruebas de escritura llevadas a cabo en 2015 con varios lotes de bolígrafos, bolígrafos de gel y rollers.

ENCENDEDORES BIC®. Los trabajadores de las fábricas de encendedores BIC® dedican una cuarta parte de su jornada a realizar controles de calidad. Todos los encendedores BIC® se someten a más de 50 controles de calidad y seguridad antes de salir de la fábrica. Todos los encendedores de bolsillo BIC® cumplen o superan la reglamentación y los estándares internacionales.

MAQUINILLAS DE AFEITAR BIC®. El 100 % de todas las hojas de afeitar se inspeccionan visualmente: control de estadística dimensional, medición de ángulos de afilado, verificación de perfecta suavidad en el borde de la hoja, etc. Se necesitan 30 controles diferentes para que una maquinilla de afeitar de 3, 4 o 5 hojas cumpla con los estrictos estándares de calidad de BIC. Las tres fábricas de producción de maquinillas de afeitar de BIC han sido triplemente certificadas: ISO 9001, ISO 14001 y OHSAS 18001.

IMPRESIÓN. Nuestras tintas cumplen con la normativa de la UE. Todas las técnicas de impresión se validan tras someterlas a cinco pruebas distintas:

- Prueba de adhesión
- Prueba de arañazos (ISO 12137:11)
- Prueba de abrasión
- Prueba de resistencia
- Prueba de exposición a la transpiración artificial

Todos los pedidos de productos imprimidos pasan 4 controles distintos:
• Control de aspecto estético • Control del color de impresión
• Control de la adherencia de impresión • Resistencia a los arañazos

IT> Safety & Quality

Qualità e sicurezza non sono solo tematiche di tendenza. Per BIC Graphic Europe sono un asset strategico e fanno parte del DNA del gruppo BIC. Ogni giorno negli stabilimenti BIC vengono fabbricati 32 milioni di prodotti. La loro qualità viene verificata da più controlli che rispettano le norme e i requisiti di sicurezza nazionali e internazionali. La professionalità dei dipendenti unita a un sistema rigoroso di controllo qualità e una costante attenzione all'innovazione tecnologica assicurano ai prodotti BIC® una qualità superiore.

ARTICOLI DI CANCELLERIA BIC®. Il 100% delle penne a sfera sono realizzate attraverso un processo altamente controllato. Perfettamente sferiche, sono quasi più dure di un diamante. 7.250 chilometri: la lunghezza dei test di scrittura effettuati nel 2015 su lotti di penne a sfera, penna a gel e roller.

ACCENDINI BIC®. Un quarto di una giornata lavorativa di un dipendente nella fabbrica di accendini BIC® è dedicato ai controlli di qualità. Ogni accendino BIC® è sottoposto a oltre 50 processi automatici di controllo qualità e sicurezza. Tutti gli accendini tascabili BIC® soddisfano o eccedono i requisiti delle normative internazionali.

RASOI BIC®. Il 100% delle lame dei rasoi sono sottoposte a ispezioni visive: controlli statistici dimensionali, misurazioni angolari dell'affilatura, valutazioni della perfetta morbidezza del filo della lama, ecc. 30 diversi controlli per produrre un rasoio a 3, 4 o 5 lame conforme ai rigidi standard qualitativi BIC. 3 volte certificate. I tre stabilimenti di produzione di rasoi BIC vantano una tripla certificazione: ISO 9001, ISO 14001 e OHSAS 18001.

STAMPA. I nostri inchiostri sono conformi alle normative UE. Ogni tecnica di stampa viene convalidata attraverso 5 diversi test:

- Test adesione
- Test graffi (ISO 12137:11)
- Test abrasione
- Test impatto
- Esposizione al test di sudorazione artificiale

Ogni ordine stampato supera 4 diversi controlli:
• Controllo dell'aspetto cosmetico • Controllo del colore della stampa
• Controllo dell'aderenza della stampa • Resistenza ai graffi





safety & Quality

Quality & safety are not just trendy topics. At BIC Graphic Europe it's a strategic asset and it's part of the DNA of the BIC Group. 32 million products are manufactured daily in BIC Group factories. Their quality is checked by multiple controls that respect national and international safety regulations and requirements.

Well-trained employees, a rigorous quality control system and a focus on continuous improvement by the Research & Development team, ensure BIC® products are of the highest quality.



BIC® STATIONERY PRODUCTS

100% of pen balls are made through a highly-controlled process. Perfectly spherical, they are almost harder than a diamond.

7,250 kilometers the length of writing tests carried out in 2015 on batches of ballpoint pens, gel pens and rollers.



BIC® LIGHTERS

One quarter of an operator's workday in a BIC® lighter factory is dedicated to quality checks.

Every BIC® lighter undergoes more than 50 automatic quality and security checks before leaving the factory.

All BIC® pocket lighters meet or exceed international standards and regulatory requirements. (ISO 9994, EN13869).

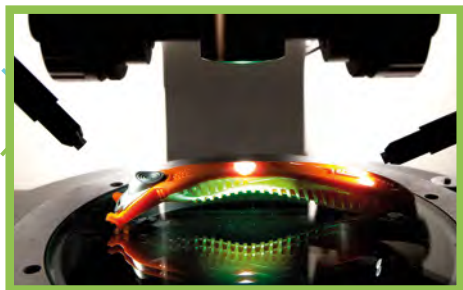

BIC® SHAVERS

100% of all razor blades are visually inspected: dimensional statistics checks, sharpening angle measurements, perfect smoothness of the blade-edge assessments, etc.

30 different controls to make a 3, 4 or 5-blade razor that conforms to BIC®'s stringent quality standards.

BIC®'s three shaver production factories have been triple-certified: ISO 9001, ISO 14001 and OHSAS 18001.



PRINTING

Our inks are compliant with the EU regulations.

Printing tests. Every imprint technique is validated through 5 different tests:

- Adhesion Test
- Abrasion Test
- Exposure to artificial perspiration test
- Scratch test (ISO 12137:11)
- Tumble Test

Every **imprinted order** passes 4 different controls:

- Cosmetic Appearance control
- Imprint adherence control
- Imprint Colour control
- Resistance to scratch



FR> Nos avantages BIC Graphic

MARQUE BIC®

Votre nom sera associé à des produits de qualité.
La marque BIC® est reconnue par 9 personnes sur 10 !

INNOVATION

Fabriqué et imprimé en EUROPE

EXPERTISE EN MATIÈRE D'IMPRESSION

Plus de 50 années d'expérience dans le domaine de l'impression

CERTIFICATIONS ISO 9001 ET ISO 14001

Par Lloyd's Register, relatives aux systèmes de gestion intégrée pour les installations de Tarragone (Espagne)

MONDE EN LIGNE

MIX & MATCH

Plus de 10.000 combinaisons de couleurs GRATUITES pour les composants standard!

GARANTIE STOCK

Des centaines d'articles toujours en stock

SERVICE D'IMPRESSION EN 48 HEURES GRATUIT !

Plus de 100 produits !

GRATUIT !

- Coûts de préparation
- Échantillons virtuels
- Conception graphique
- Échantillons physiques
- Etc.

DE> Unsere BIC-Graphic-Vorteile BIC®-MARKE

Ihr Name wird mit Qualitätsprodukten assoziiert.
9 von 10 Personen kennen die Marke BIC®

INNOVATION

Hergestellt und gedruckt in EUROPA

ERFAHRUNG IN DRUCKTECHNIKEN

Über 50 Jahre Erfahrung im Drucken

ISO 9001 - ISO 14001 ZERTIFIZIERUNGEN

Für integrierte Qualitäts- und Umweltmanagementsysteme für ihre Werke in Tarragona (Spanien) vom Lloyd's Register erhalten

ONLINE-WELT

MIX & MATCH

Über 10.000 KOSTENLOSE Farbkombinationen bei den Standardkomponenten!

LAGERBESTANDS-VERSPRECHEN

Hunderte von Artikeln immer am Lager

48-STUNDEN-DRUCKSERVICE KOSTENLOS!

Für über 100 Produkte!

KOSTENLOS!

- Druckeinrichtungskosten
- Virtuelle Muster
- Graphik und Design
- Materialmuster
- Und vieles andere mehr...

ES> Nuestras ventajas BIC® Graphic

MARCA BIC®

Tu nombre estará asociado a productos de calidad.
La marca BIC® es reconocida por 9 de cada 10 personas

INNOVACIÓN

Fabricado e impreso en EUROPA

EXPERIENCIA EN IMPRESIÓN

Más de 50 años de experiencia en impresión

CERTIFICACIONES ISO 9001 - ISO 14001

Sistemas Integrados de Gestión para las instalaciones de Tarragona, por Lloyd's Register

MUNDO ONLINE

MIX & MATCH

Más de 10.000 combinaciones de colores GRATUITAS para componentes estándar

PROMESA DE INVENTARIO

Cientos de artículos siempre en stock

¡SERVICIO DE IMPRESIÓN EN 48 HORAS GRATIS!

¡En más de 100 productos!

GRATIS

- Gastos fijos de impresión
- Muestras virtuales
- Artes gráficas
- Muestras físicas
- Y mucho más...

IT> I nostri vantaggi BIC Graphic MARCHIO BIC®

Il tuo nome sarà associato a prodotti di altissima qualità.
Il marchio BIC® è riconosciuto da 9 persone su 10

INNOVAZIONE

Prodotto e stampato in EUROPA

COMPETENZA NELLA STAMPA

Oltre 50 anni di esperienza nella stampa

CERTIFICAZIONI ISO 9001 - ISO 14001

Da Lloyd's Register, al Sistema di Gestione Integrato per gli stabilimenti di Tarragona (Spagna)

MONDO ONLINE

MIX & MATCH

Oltre 10.000 combinazioni di colori GRATUITE per i componenti!

SICUREZZA DI INVENTARIO

Centinaia di articoli sempre disponibili

SERVIZIO DI STAMPA IN 48 ORE GRATIS!

Oltre 100 prodotti!

GRATIS!

- Costi d'impianto
- Campioni virtuali
- Bozza grafica
- Campioni fisici
- E altro ancora...



BIC graphic our advantages



BIC® BRAND

Your name will be associated with quality products.
The BIC® brand is recognised by 9 out of 10 people



INNOVATION

Manufactured and printed in EUROPE

CMYK

PRINTING EXPERTISE

Over **50 years of printing** expertise



ISO 9001 - ISO 14001

Integrated Management System Certifications for the Tarragona facilities from Lloyd's Register



ONLINE WORLD

www.bicgraphic.eu



MIX & MATCH

MIX & MATCH

OVER 10,000 FREE standard component colour combinations!



INVENTORY PROMISE

Hundreds of items **always** in stock



FREE 48H PRINTING SERVICE!

For over 100 products!

FREE!

FREE

- » Set up charges
- » Visuals
- » Artwork proofs
- » Physical samples
- » And much more...



FR> Techniques d'impression

FAITES RESSORTIR VOTRE MARQUE GRÂCE À NOS TECHNIQUES D'IMPRESSION ET FINITIONS

- SÉRIGRAPHIE (y compris les encres en relief et métalliques)
- TAMPOGRAPHIE
- IMPRESSION NUMÉRIQUE
- GRAVURE LASER
- BRITEPIX™
- DOMING
- MARQUAGE À CHAUD
- TEXTURE BRITEPIX™
- GAUFRAGE
- IMPRESSION TRANSFERT
- IMPRESSION RELIEF 3D
- SUBLIMATION
- ENCRE MÉTALLIQUE
- FLUORESCENT

LA GARANTIE INHÉRENTE À PLUS DE 50 ANNÉES D'EXPÉRIENCE !

ES> Técnicas de impresión

HAZ QUE TU MARCA DESTAQUE CON NUESTROS ACABADOS Y TÉCNICAS DE IMPRESIÓN

- SERIGRAFÍA (Incluye Puffy y tintas metálicas)
- TAMPOGRAFÍA
- IMPRESIÓN DIGITAL
- GRABADO LÁSER
- BRITEPIX™
- GOTA DE RESINA
- TERMOGRABADO CON COLOR
- BRITEPIX™ TEXTURE
- TERMOGRABADO
- TRANSFER SERIGRAFICO
- IMPRESIÓN PUFFY EN 3D
- SUBLIMACIÓN
- TINTA METÁLICA
- BRILLA EN LA OSCURIDAD

IMÁS DE 50 AÑOS DE EXPERIENCIA NOS AVALAN!

DE> Drucktechniken

STELLEN SIE IHRE MARKE MIT UNSEREN DRUCKTECHNIKEN UND -OBERFLÄCHEN IN DEN VORDERGRUND

- SIEBDRUCK (einschließlich Puffy- und Metallic-Farben)
- TAMPONDRUCK
- DIGITALDRUCK
- LASERGRAVUR
- BRITEPIX™
- DOMING
- HEISSPRÄGEN
- BRITEPIX™ TEXTURE
- TIEFPRÄGUNG (DEBOSSING)
- SIEBTRANSFERDRUCK
- 3D-PUFFY-DRUCK
- SUBLIMATION
- METALLIC-FARBE
- GLANZ IM DUNKELN

ÜBER 50 JAHRE GARANTIERTE ERFAHRUNG!

IT> Tecniche di stampa

METTI IN LUCE IL TUO MARCHIO GRAZIE ALLE NOSTRE TECNICHE DI STAMPA E FINITURE

- SERIGRAFIA (compresi inchiostri puffy e metallici)
- STAMPA A TAMPONE
- STAMPA DIGITALE
- INCISIONE LASER
- BRITEPIX™
- DOMING
- STAMPA A CALDO
- TEXTURE BRITEPIX™
- STAMPA DEBOSSING
- TRANSFER SERIGRAFICO
- STAMPA A RILIEVO PUFFY 3D
- SUBLIMAZIONE
- INCHIOSTRO METALLICO
- FOSFORESCENZA

CON OLTRE 50 ANNI DI ESPERIENZA COME GARANZIA!



MAKE YOUR BRAND
STAND OUT WITH OUR
 PRINTING TECHNIQUES AND FINISHES

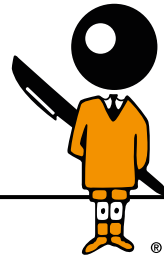

SCREEN PRINTING
 (Including Puffy & Metallic inks)



PAD PRINTING



DIGITAL PRINTING



LASER ENGRAVING



BRITEPIX™



DOMING



HOT STAMPING



BRITEPIX™ TEXTURE



DEBOSSING



SCREEN TRANSFER

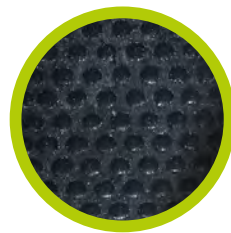

3D PUFFY PRINTING



SUBLIMATION



METALLIC INK



GLOW IN THE DARK

**WITH MORE THAN 50
 YEARS OF EXPERIENCE
 AS GUARANTEE!**



FR> Partner brands

T'nB®, notre partenaire technologique exclusif depuis plus de 30 ans, est conforme aux réglementations strictes sur les produits technologiques et apporte une conception française unique et une optique de qualité à nos clients.

Découvrez Sprout™, le crayon qui va faire verdier d'envie les crayons plastique ! Utilisez votre crayon, puis plantez-le et regardez-le pousser.

SKROSS® - réputé dans le monde entier pour sa sécurité, sa simplicité et sa nationalité Suisse : profitez pleinement de votre voyage grâce au n° 1 des adaptateurs de voyage !

ES> Partner brands

T'nB® - nuestro exclusivo colaborador de tecnología que lleva innovando más de 30 años, cumple con las estrictas normativas de los productos tecnológicos, aporta a sus clientes un diseño francés único y la excelencia en calidad a los clientes.

Conoce Sprout™, ¡el lápiz que hace que los bolígrafos de plástico se pongan verdes de envidia! Usa el lápiz, luego plántalo y mira como crece.

SKROSS® - reconocido mundialmente como seguro, simple y Suizo: ¡disfruta de una viaje inolvidable con el número 1 en potencia!

DE> Partner brands

T'nB®, unsere seit mehr als 30 Jahren innovativ arbeitende exklusive Technologiepartnermarke, erfüllt die strengen Vorschriften für Technologieprodukte und bringt unseren Kunden einzigartiges französisches Design in hochwertiger Qualität.

Lernen Sie Sprout™ kennen, den Bleistift, bei dem Plastikstifte grün vor Neid werden! Benutzen Sie Ihren Bleistift, pflanzen Sie ihn danach ein und schauen Sie zu, wie er wächst.

SKROSS® - auf der ganzen Welt berühmt als sicher, simpel, aus der Schweiz: Genießen Sie eine unvergessliche Reise mit der Nr. 1 in Sachen Strom auf Reisen!

IT> Partner brands

T'nB®, il nostro esclusivo marchio partner in tecnologia innovativa da oltre 30 anni, rispetta le severe regolamentazioni sui prodotti tecnologici e offre ai tuoi clienti un design francese unico e una qualità eccellente!

Scopri Sprout™, la matita che fa diventare le penne in plastica verdi d'invidia! Usa la tua matita, poi piantala e guardala crescere.

SKROSS® - globalmente riconosciuto come sicuro, semplice e svizzero: Goditi un viaggio indimenticabile con il numero 1 negli adattatori da viaggio!





T'nB® - our exclusive technology partner brand innovating for more than 30 years, meets the strict regulations of technological products bringing a unique French design and quality excellence to your clients.



Sprout

Meet Sprout™, the pencil that makes plastic pens green with envy! Use your pencil, then plant it and watch it grow.



SKROSS® - globally renowned as safe, simple and Swiss: Enjoy an unforgettable journey with the # 1 in travel power!



FR> Outils numériques
DESSINÉ POUR VOUS!
PRATIQUE ET UTILE!

BIC GRAPHIC APP

- **VIVEZ** UNE EXPÉRIENCE INCROYABLE DE RÉALITÉ AUGMENTÉE AVEC DES EFFETS SURPRENANTS.
- **JOUEZ** AVEC LE CONFIGURATEUR PRODUIT 3D POUR SÉLECTIONNER VOTRE CHOIX DE COMBINAISONS DE COULEURS
- **TÉLECHARGEZ** VOTRE LOGO
- **REGARDEZ** LES VIDÉOS DES PRODUITS BIC® LES PLUS ICONIQUES
- **CUSTOMISEZ** VOS IMAGES AVEC LE SERVICE DE PERSONALISATION

SCANNEZ CETTE ICONE SUR LES PAGES PRODUITS ET VOUS VERREZ LES PRODUITS PRENDRE VIE!

DE> Digitale Tools
FÜR SIE ENTWORFEN!
PRAKTISCH UND HILFREICH!

BIC GRAPHIC APP

- **ERLEBEN** SIE EINE UNGLAUBLICHE ERFAHRUNG DER „ERWEITERTEN REALITÄT“ MIT ÜBERRASCHENDEN EFFEKTEN
- **SPIELEN** SIE MIT DEM 3D-PRODUKTKONFIGURATOR UM IHRE GEWÜNSCHTE FARBKOMBINATION AUSZUWÄHLEN
- **LADEN** SIE IHR LOGO HOCH
- **SEHEN** SIE SICH DIE PRODUKTVIDEOS DER KULTIGSTEN BIC®-PRODUKTE AN
- **PASSEN** SIE IHRE FOTOS MIT DEM PERSONALISIERUNGSSERVICE AN

SCANNEN SIE DIESES ICON AUF DEN PRODUKTSEITEN UND ERLEBEN SIE, WIE DAS PRODUKT ZUM LEBEN ERWECKT WIRD!

ES> Herramientas digitales
DISEÑADA PARA TI!
PRÁCTICA Y ÚTIL!

BIC GRAPHIC APP

- **VIVE** UNA EXPERIENCIA INCREIBLE DE REALIDAD AUMENTADA CON EFECTOS SORPRENENTES
- **JUEGA** CON EL CONFIGURADOR DE PRODUCTOS 3D Y SELECCIONA LA COMBINACIÓN DE COLORES.
- **CARGA** TU LOGO
- **MIRA** LOS VIDEOS DE LOS PRODUCTOS MÁS EMBLEMÁTICOS DE BIC®
- **MODIFICA** TUS IMÁGENES CON EL SERVICIO DE PERSONALIZACIÓN

¡AL ESCANEAR UNA DE LAS PÁGINAS DEL CATÁLOGO QUE PRESENTA EL SIGUIENTE ICONO, PODRÁS VER QUE EL PRODUCTO SE CONVIERTE EN REALIDAD!

IT> Strumenti digitali
PROGETTATI PER TE!
PRATICI E UTILI!

BIC GRAPHIC APP

- **VIVI** UN'ESPERIENZA INCREDIBILE DI REALTÀ AUMENTATA CON EFFETTI SORPRENENTI.
- **GIOCA** CON IL CONFIGURATORE DI PRODOTTI 3D E SELEZIONA LA TUA COMBINAZIONE DI COLORI.
- **CARICA** IL TUO LOGO.
- **GUARDA** IL VIDEO DEI PRODOTTI PIÙ ICONICI DI BIC
- **MODIFICA** LA TUA IMMAGINE CON IL SERVIZIO DI PERSONALIZZAZIONE

SCANNERIZZA QUESTA ICONA NELLE PAGINE DEI PRODOTTI E VEDRAI IL PRODOTTO PRENDERE VITA!



DESIGNED FOR YOU!
PRACTICAL AND USEFUL!

BIC GRAPHIC APP



LIVE

AN INCREDIBLE EXPERIENCE
OF **AUGMENTED REALITY**
WITH SURPRISING EFFECTS

PLAY

AROUND WITH THE **3D
PRODUCT CONFIGURATOR**
TO SELECT YOUR DECIDED
COLOUR COMBINATION

UPLOAD

YOUR **LOGO**

WATCH

THE PRODUCT VIDEOS OF THE
MOST ICONIC BIC® PRODUCTS

CUSTOMISE

YOUR PICTURES WITH
PERSONALIZATION SERVICE

SCAN THIS ICON
ON THE PRODUCT
PAGES AND



YOU'LL SEE THAT
THE PRODUCT
COMES TO LIFE!



FR> Outils numériques

LE CATALOGUE BIC GRAPHIC TOUJOURS AVEC VOUS

LA VERSION NUMÉRIQUE DU CATALOGUE GÉNÉRAL 2019

Information mise à jour continuellement!

Disponibilité des produits, calculateur de prix, stock, recherche avancée, marque pages, promotions en cours et bien plus encore...

NOTRE BOUTIQUE EN LIGNE

SAISISSEZ VOS COMMANDES RAPIDEMENT ET FACILEMENT!

- Complétez l'information produit : détails produits et images, disponibilité du stock, prix, possibilités d'impression, packaging et les outils multimedia.
- Configurateur produit: configurateur 2D et 3D pour tous les produits. Téléchargez votre logo et obtenez une maquette virtuelle.
- Prix tout inclus : facile, un prix avec tout inclus: set up charges, impression et coût de transport.
- E-cotation: les conditions tarifaires avec toutes les informations requises avec votre logo en un seul click !
- Commande en ligne : processus de commande complet, une vue des commandes en cours ou passées, les attentes d'accord sur les fiches de marquage et les factures, etc.
- Assistance en ligne : tchat en ligne.
- Besoin d'un site internet ? : Construction facile de votre propre site internet basé sur notre propre modèle, gratuitement !

DE> Digitale Tools

BIC GRAPHIC KATALOG FÜR UNTERWEGS

DIE DIGITALE VERSION DES 2019 GESAMTKATALOGES

Konstant aktualisierte Informationen!

Produktverfügbarkeit, Preiskalkulator, Lagerbestand, erweiterte Suche, Lesezeichen, laufende Promotions und vieles mehr...

UNSER ONLINE SHOP

PLATZIEREN SIE IHRE BESTELLUNGEN SCHNELLER UND EINFACHER!

- Vollständige Produktinformation: Produktdetails und -fotos, Lagerverfügbarkeit, Preis, Druckmöglichkeiten, Verpackung und Multimedia Tools.
- Produktkonfigurator: 2D- und 3D- Konfigurator für alle Artikel. Laden Sie Ihr Logo hoch und erhalten Sie ein kostenloses virtuelles Muster.
- All-inklusive-Preis: einfach, ein Preis inklusive aller Extras: Einrichtungskosten, Druck- und Transportkosten.
- E-Angebot: alle benötigten Informationen inklusive Ihres eigenen Logos und Preiskonditionen mit nur einem Klick!
- Online-Bestellungen: vollständige Bestellabwicklung, Überblick über aktuelle und frühere Bestellungen, anstehende Druckvorlagen, Freigaben und Rechnungen etc.
- Online-Assistenz: Live-Chat.
- Sie benötigen eine Website?: Erstellen Sie sich Ihre eigene.

ES> Herramientas digitales

CATÁLOGO BIC GRAPHIC EN MARCHA

LA VERSIÓN DIGITAL DEL CATÁLOGO GENÉRICO 2019

¡Un lugar donde la información está siempre actualizada!

Disponibilidad del producto, calculadora de precios, inventario, búsqueda avanzada, marcadores, promociones en curso y mucho más...

NUESTRA TIENDA ONLINE

¡HAZ TUS PEDIDOS MÁS RÁPIDO Y MÁS FÁCIL!

- Información completa del producto: detalles e imágenes del producto, disponibilidad de stock, precio, posibilidades de impresión, embalaje y herramientas multimedia.
- Configurador de productos: configurador 2D y 3D para todos los artículos. Sube tu logo y obtén una muestra virtual gratuita. Precio todo incluido: fácil, un precio que lo incluye todo: gastos de instalación, impresión y transporte.
- E-quotation: itoda la información requerida con tu propio logo y tus condiciones de precios con un solo clic!
- Pedidos en línea: proceso completo de pedidos, resumen de pedidos actuales y pasados, aprobaciones y facturas pendientes de artes finales, etc.
- Asistencia online: chat en vivo.
- ¿Necesitas un sitio web?: ¡Crea fácilmente tu propio sitio web basado en nuestro propio modelo, gratis!

IT> Strumenti digitali

CATALOGO BIC GRAPHIC IN MOVIMENTO

VERSIONE DIGITALE DEL CATALOGO GENERALE 2019

Informazioni costantemente aggiornate!

Disponibilità prodotti, calcolatore prezzi, stock, ricerca avanzata, segnalibri, promozioni in corso e molto di più...

IL NOSTRO NEGOZIO ONLINE

FAI I TUOI ORDINI PIU' VELOCEMENTE E PIU' FACILMENTE!

- Informazione completa del prodotto: dettagli e immagini del prodotto, disponibilità, prezzo, possibilità di stampa, imballo e strumenti multimedia.
- Configuratore prodotto: configuratore 2D e 3D per tutti gli articoli. Carica il tuo logo e ottieni un campione virtuale.
- Prezzo all inclusive: facile, un prezzo con tutto incluso: impianto, stampa e trasporto.
- E-quotation: tutte le informazioni con il tuo logo e le tue condizioni di prezzo con un solo clic!
- Ordini online: processo completo dell'ordine, visualizzazione degli ordini in corso e passati, approvazione delle bozze in attesa e fatture, etc.
- Assistenza online: live chat.
- Necessiti di un sito?:
- Crea facilmente il tuo sito sulla base del nostro gratuitamente!

BIC GRAPHIC CATALOGUE ON THE GO



THE DIGITAL VERSION OF THE 2019 GENERAL CATALOGUE

Information constantly updated!
Product availability, stock,
advanced searching, bookmarks, ongoing
promotions and much more...



OUR ONLINE SHOP

PLACE YOUR ORDERS FASTER AND EASIER!

- **Complete product information:** product details and images, stock availability, price, printing possibilities, packaging and multimedia tools
- **Product configurator:** 2D and 3D configurator for all items. Upload your logo and get a free visual.
- **All inclusive price:** easy, one price with everything included: set up charges, printing & transport costs
- **E-quotation:** all the information required with your own logo and pricing conditions with just one click!
- **Online orders:** complete order processing, overview of current and past orders, pending artworks approvals and invoices, etc.
- **Online assistance:** live chat
- **Need a website?:** Easily build your own website based on our own model for free!

www.bicgraphic.eu





Table of contents

BIC® WRITING INSTRUMENTS

BALLPENS - 44
METALLIC PENS - 122
ROLLERS & GELS - 130
HIGHLIGHTERS & MARKERS - 150
PENCILS - 160
Sprout PENCIL - 172
COLOURING PENS - 176
CORRECTION - 190

OTHER WRITING INSTRUMENTS

PLASTIC PENS - 194
STYLUS PENS - 202

BIC® STICKY NOTES

ADHESIVE NOTEPADS - 206
BOOKLETS - 224
SCRATCH PAD - 242

BIC® NOTEBOOKS

NOTEBOOKS - 248

OFFICE ACCESSORIES

MOUSE PAD - 258
MUGS - 259



BIC® LIGHTERS & CASES

LIGHTERS - 266
LIGHTER CASES - 290
OTHER PRODUCTS - 296

BIC® SHAVERS

FOR MEN - 302
FOR WOMEN - 308

BIC® BAGS

BACKPACKS - 318
ACCESSORIES - 322

TECHNOLOGY

 - 326

 **SKROSS®** - 350
ADAPT TO THE WORLD

BIC® PACKAGING

WRITING INSTRUMENTS SPECIAL PACKAGING - 355
LIGHTERS SPECIAL PACKAGING - 357

GENERAL INFORMATION

48-HOUR PRINTING SERVICE! - 359
STICKY NOTES GENERAL INFORMATION - 361
SYMBOLS & ABBREVIATIONS - 363
GENERAL INFORMATION - 365
PRODUCT INDEX - 366
COLOUR TABLE - 367
MAKE IT SIMPLE! - 368



BALLPENS

- 110 BIC® 4 Colours
- 121 BIC® 4 Colours 3+1HB
- 114 BIC® 4 Colours Fashion
- 118 BIC® 4 Colours Fine
- 119 BIC® 4 Colours Fluo
- 112 BIC® 4 Colours Mini
- 116 BIC® 4 Colours Shine
- 120 BIC® 4 Colours Stylus
- 113 BIC® 4 Colours Sun
- 100 BIC® Atlantis®
- 104 BIC® Clic Ecolutions®
- 107 BIC® Clic Gold Ecolutions®
- 70 BIC® Clic Stic
- 72 BIC® Clic Stic Ecolutions®
- 75 BIC® Clic Stic Mini Digital
- 74 BIC® Clic Stic Softfeel®
- 74 BIC® Clic Stic Stylus
- 54 BIC® M10® Clic
- 58 BIC® Media Clic
- 63 BIC® Media Clic Ecolutions®
- 64 BIC® Media Clic Grip®
- 65 BIC® Media Clic Grip Ecolutions®
- 69 BIC® Media Clic Premium
- 48 BIC® Round Stic®
- 51 BIC® Round Stic® Ecolutions®
- 44 BIC® Style
- 46 BIC® Style Clear

- 80 BIC® Super Clip
- 86 BIC® Super Clip Advance
- 83 BIC® Super Clip Ecolutions®
- 90 BIC® Wide Body™
- 94 BIC® Wide Body™ Chrome
- 93 BIC® Wide Body™ Ecolutions®
- 95 BIC® Wide Body™ Mini Digital
- 95 BIC® Wide Body™ Mini Digital Chrome

METALLIC PENS

- 124 BIC® Attriant®
- 125 BIC® Protrusion Grip
- 129 BIC® Tri-Tone Twist
- 126 BIC® Wide Body™ Metal

ROLLERS & GELS

- 134 BIC® Atlantis® Gel
- 130 BIC® Gel-Ocity® Illusion
- 136 BIC® Grip Roller
- 139 BIC® Grip Roller Gold
- 140 BIC® Intensity® Gel Clic
- 144 BIC® Roller Glide® PRO
- 146 BIC® XS Finestyle

HIGHLIGHTERS & MARKERS

- 150 BIC® Brite Liner® Grip
- 158 BIC® Mark-it Permanent Marker
- 159 BIC® Permanent Marker Ecolutions®
- 156 BIC® Velleda® White Board Marker Fine
- 157 BIC® Velleda® White Board Marker Grip

PENCILS

- 166 BIC® Evolution® Ecolutions®
- 160 BIC® Matic®
- 163 BIC® Matic® Ecolutions®
- 164 BIC® Matic® Grip
- 164 BIC® Matic® Quartz
- 58 BIC® Media Clic
- 63 BIC® Media Clic Ecolutions®
- 64 BIC® Media Clic Grip
- 172 Sprout™

COLOURING PENS

- 187 BIC® Evolution® Ecolutions® Colouring set
- 179 BIC® Evolution® Ecolutions® set of 6 colouring pencils
- 185 BIC® Plastidecor® Colouring Set
- 177 BIC® Plastidecor® set of 6 crayons
- 186 BIC® Visa® Colouring Set
- 178 BIC® Visa® set of 6 felt pens
- 188 Conté® by BIC® Colouring Set
- 180 Conté® set of 6 colouring pencils

CORRECTION

- 190 Tipp-EX® Mini Pocket Mouse *briteDix*™

OTHER WRITING INSTRUMENTS

- 194 Basic pen
- 196 Click pen
- 202 Sleek Stylus Executive pen
- 202 Sleek Stylus Matt pen
- 202 Sleek Stylus pen
- 198 Striped Grip pen
- 200 White Striped Grip pen





writing instruments





Worldwide recognised BIC® cap shape in opaque & clear finishes. Excellent value for money.

FR > La célèbre forme du capuchon BIC® en finition claire et opaque. Excellent rapport qualité/prix.

ES > Tapón BIC® reconocido mundialmente, en sus acabados opaco y clear. Excelente relación precio-calidad.

DE > Auf der ganzen Welt bekannte BIC®-Kappenform in opaker und durchsichtiger Ausführung. Hervorragendes Preis-Leistungs-Verhältnis.

IT > Il cappuccio BIC® riconosciuto in tutto il mondo con finiture opache e lucide. Eccellente rapporto qualità/prezzo.





BALLPENS
BIC® WRITING INSTRUMENTS





BIC® style
OPAQUE - 1610

CLEAR - 1610

BIC® WRITING INSTRUMENTS
BALLPENS



01/01 01/03 01/05 01/04

Colour ink
Encre de couleur
Color de la tinta
Schreibfarbe
Colore inchiostro



02/02



01/02



92 87 93 88 89 8H



93



MOQ 500v.

Decoration:

Personnalisation / Personalización / Dekoration / Decorazione

BIC® Style

1610

A SP: max. 2 col.

BIC® Style Clear

1610

B SP: max. 1 col.

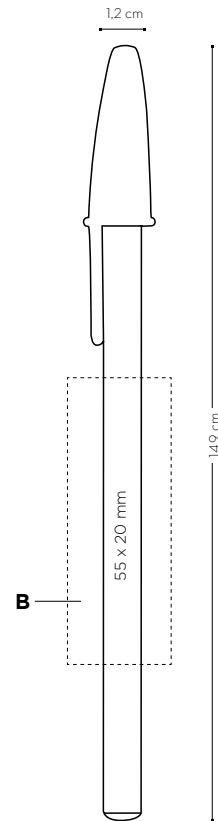
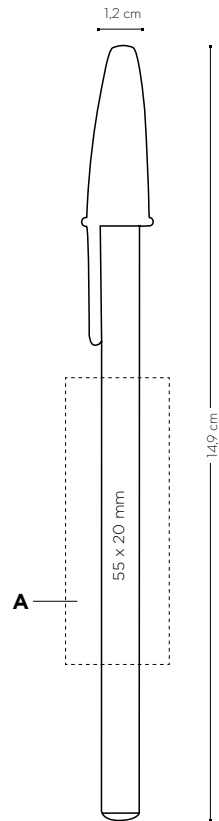

Price (€)

BIC® Style / BIC® Style Clear	500-999	1000-2499	2500-4999	5000-9999	10000-24999	25000-49999
1610						
SP	0,42	0,38	0,36	0,34	①	①

ADDITIONAL IMPRINT CHARGE PER COLOUR & POSITION frais d'impression supplémentaires par couleur et position / cargo por impresión adicional por color y posición / zusätzliche druckkosten pro farbe & position / costo marchio aggiuntivo per colore e posizione

SP	0,13	0,13	0,13	0,12	①	①
-----------	------	------	------	------	---	---

Prices include 1 colour screenprint in one position. Les prix incluent la sérigraphie 1 couleur sur un emplacement. En precio incluye un color en serigrafía en una posición. In den Preisen inbegriffen ist 1 Siebdruck-Farbaufdruck auf 1 Position. I prezzi includono 1 colore a serigrafia in una posizione.

① Price under request. Prix sur demande. Precio bajo consulta. Preis auf Anfrage. Prezzi su richiesta.

Writing modes:

Mode écriture / Modos de escritura / Schreibmodi / Modalità di scrittura

Ballpen



M

Printing techniques:

Techniques d'impression / Técnicas de impresión / Drucktechniken / Tecniche di stampa



(SP) SCREEN PRINTING

External packaging:

Emballage externe / Envasado exterior / Außenverpackung / Imballaggio esterno



500 ± 3,5 Kg



The iconic BIC® Round Stic® offers timeless style and high quality. Its classic design is easy to identify and symbolises long-term reliability.

FR > L'icône BIC® Round Stic® offre un style in démodable et une très grande qualité. Son design classique est facile à identifier et symbolise une fiabilité à long terme.

ES > El icónico BIC® Round Stic® ofrece un estilo atemporal y de calidad. Su diseño clásico se identifica fácilmente y simboliza la fiabilidad a largo plazo.

DE > Unser kultiger BIC® Round Stic® bietet zeitloses Design in hoher Qualität. Sein klassisches Design ist einfach zu erkennen und steht für lang anhaltende Zuverlässigkeit.

IT > L'iconica BIC® Round Stic offre uno stile intramontabile ed alta qualità. Il suo design classico la rende facilmente riconoscibile ed è prova di una lunga affidabilità.

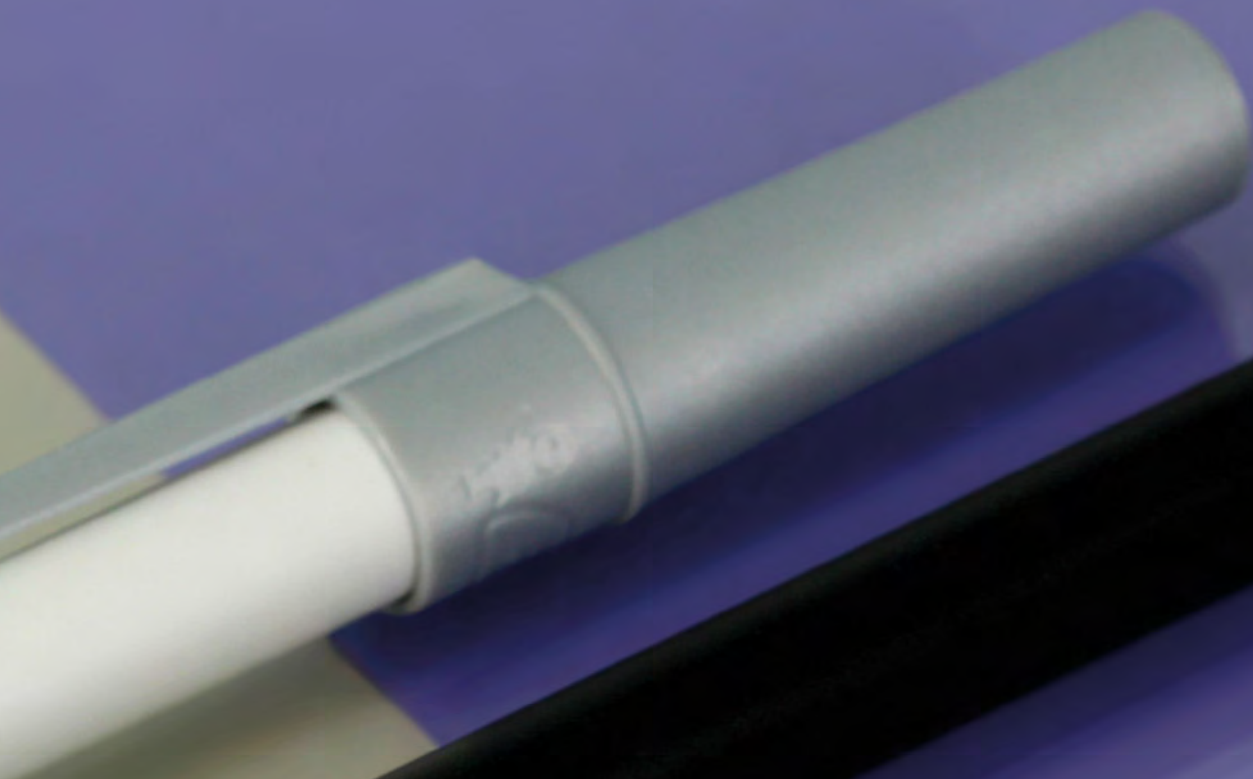



OPAQUE - 1010

FROSTED - 1010

Iconic BIC® Boy is embossed

BIC® WRITING INSTRUMENTS

BALLPENS

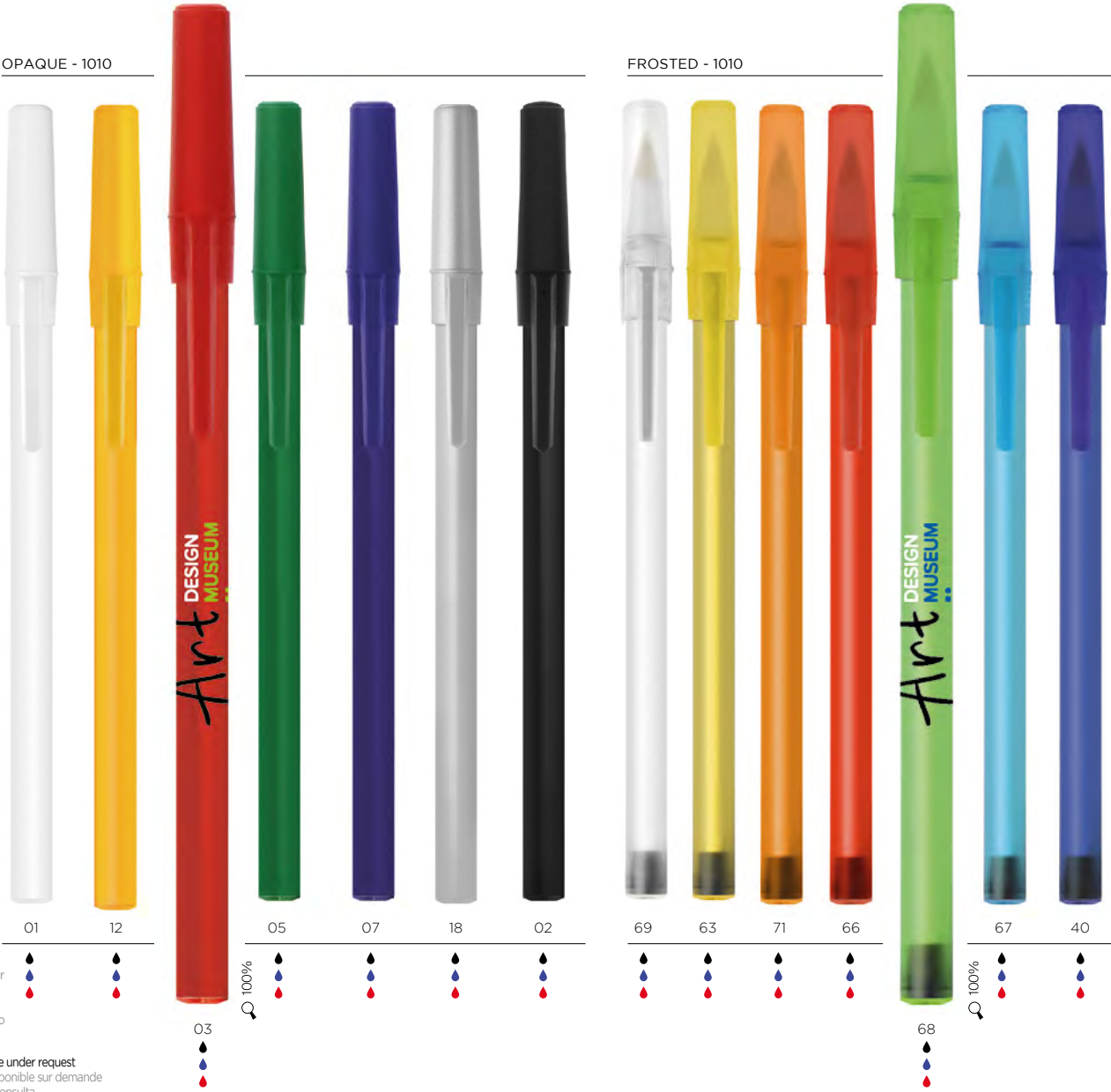

Colour ink
Encre de couleur
Color de la tinta
Schreibfarbe
Colore inchiostro

Red Ink available under request
Encre rouge disponible sur demande
Tinta roja bajo consulta
Rote Tinte auf Anfrage erhältlich
Inchiostro rosso disponibile su richiesta



*48h not available in Digital finishes 48h not available in Digital finishes / 48h not available in Digital finishes / 48h not available in Digital finishes / 48h not available in Digital finishes



ecolutions® 69%
 OPAQUE - 1E10



1E/8E

1E/7E

1E/10E



ecolutions® 69%
 FROSTED - 1E10



1E/3E

2E/8E

2E/7E

2E/10E



2E/3E

Digital Printing!

BIC® Round stic® Digital
 ecolutions®
 Version Available
 OPAQUE - 1010/1E10



1E/10E

360°



01

available in white barrel
 disponible en corps blanc
 disponible en cuerpo blanco
 mit weißem schaft erhältlich
 disponibile in fusto bianco

BALLPENS
 BIC® WRITING INSTRUMENTS



MOA 500v.

Standard colours combination

Combinaison de couleurs standards / Combinación de colores estandar / Standardfarbkombination / Combinazione colori standard

Plug

Bouton / Botón / Endstück / Pulsante



Clip

Clip / Clip / Clip / Clip

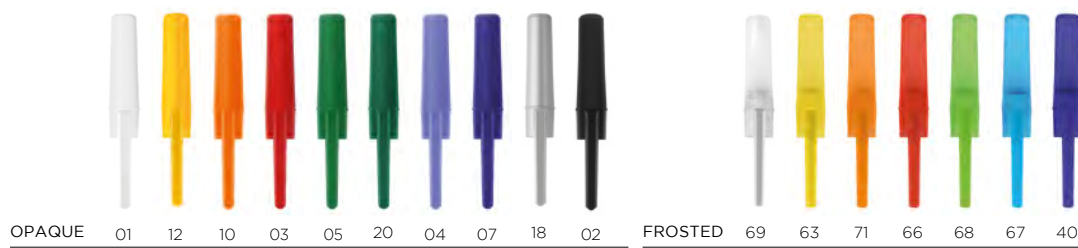

Section

Section / Sección / Teil / Sezione

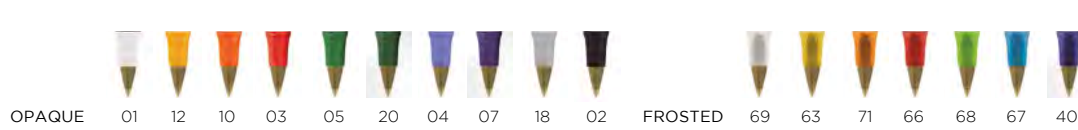

Barrel

Corps / Cuerpo / Schaft / Fusto



eColutions® standard colours combination



Exact colour match:

Correspondance exacte des couleurs / Color exacto / Exakte Farbübereinstimmung / Esatta corrispondenza di colore

≥ 10.000 units



eColutions® Made with 69% recycled material.

The percentage is calculated based on the total weight of the product.

Add the Möbius loop to your artwork at no additional charge. Please be sure to specify "Print the Möbius loop" on your order. (Möbius loop imprint defaults to left-hand hand corner.)

FR > Le pourcentage est calculé sur le poids total du produit. Ajoutez l'anneau Möbius à votre article sans frais supplémentaire. N'oubliez pas de préciser « Imprimer l'anneau Möbius » dans votre commande. (L'anneau Möbius est imprimé par défaut dans le coin supérieur gauche)

ES > El porcentaje está calculado basado en el peso total del producto. Anade el Möbius loop a tu arte final sin cargo adicional. Por favor asegúrate de especificar "imprimir el Möbius loop" en tu pedido. (La impresión del Möbius loop a mano izquierda en la esquina)

DE > Der Prozentsatz ist auf der Grundlage des Gesamtgewichts des Produkts berechnet. Zu Artwork Möbius-Loop hinzufügen, ohne Zusatzkosten. Vergessen Sie nicht "Möbius-Loop drucken" auf der Bestellung anzugeben (Möbius-Loop-Abdruck standardmäßig auf der linken Ecke).

IT > La percentuale è calcolata in base al peso totale del prodotto. Aggiungi l'anello di Möbius al tuo disegno senza costi aggiuntivi. Assicurati di specificare "Stampare anello di Möbius" nel tuo ordine. (La stampa dell'anello di Möbius va in default nell'angolo sinistro)

Writing modes:

Mode écriture / Modos de escritura / Schreibmodi / Modalità di scrittura

Ballpen



M

Printing techniques:

Techniques d'impression / Técnicas de impresión / Drucktechniken / Tecniche di stampa



(SP) SCREEN PRINTING



(DG) DIGITAL

External packaging:

Emballage externe / Envasado exterior / Außenverpackung / Imballaggio esterno



500 ± 2,5 Kg



MADE IN SPAIN

Decoration:

Personnalisation / Personalización / Dekoration / Decorazione

BIC® Round stic®

1010

@CColutions® 1E10

A SP: max. 3 col.

B SP: max. 1 col.

C DG: full-colour (available in white barrel)

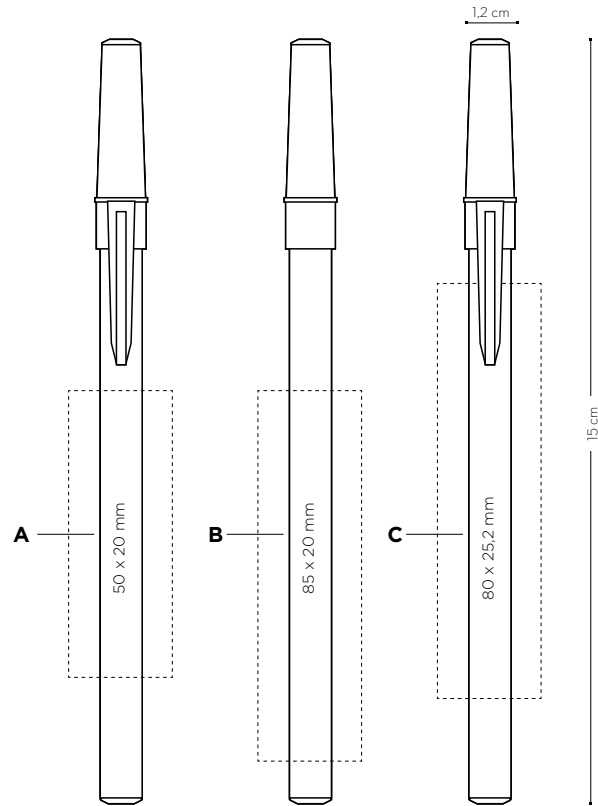

Price (€)

BIC® Round stic®

500-111 1000-2411 2500-4111 5000-9111 10000-24111 25000-41111

1010

SP	0,50	0,48	0,45	0,42	0,39	0,36
DG	0,69	0,66	0,62	0,58	①	①

@CColutions® 1E10

SP	0,56	0,53	0,49	0,46	①	①
DG	0,75	0,71	0,66	0,62	①	①

ADDITIONAL IMPRINT CHARGE PER COLOUR & POSITION frais d'impression supplémentaires par couleur et position / cargo por impresión adicional por color y posición / zusätzliche druckkosten pro farbe & position / costo marchio aggiuntivo per colore e posizione

SP 0,13 0,13 0,13 0,12 0,11 0,11

Prices include one imprint in one position according to specified technique. Les prix incluent une impression sur un emplacement avec la technique spécifiée / Los precios incluyen una impresión en una posición acorde con la técnica especificada / In den Preisen inbegriffen ist ein Aufdruck auf einer Position gemäß angegebener Technik / I prezzi includono una stampa in una posizione a seconda della tecnica specificata.

① Price under request. Prix sur demande. Precio bajo consulta. Preis auf Anfrage. Prezzi su richiesta.



A classic that transcends time with modern colours and high quality at a competitive price.



FR > Un classique revisité avec des couleurs modernes - la qualité à un prix concurrentiel.

ES > Un clásico que trasciende con colores modernos y una alta calidad a un precio competitivo.

DE > Ein Klassiker, der sich selbst übertrifft, mit modernen Farben und hoher Qualität zum attraktiven Preis.

IT > Un classico inimitabile in colori moderni e altissima qualità a un prezzo competitivo.





BIC[®] MIO[®] clic
1590



Iconic BIC[®] Boy is embossed

side push button

BIC[®] WRITING INSTRUMENTS

BALLPENS



Colour ink
Encre de couleur
Color de la tinta
Schreibfarbe
Colore inchiostro

FR > Bouton-poussoir latéral

ES > Botón pulsador lateral

DE > Seitlicher Druckknopf

IT > Pulsante laterale a pressione



MOQ 500v.

Decoration:

Personnalisation / Personalización / Dekoration / Decorazione

BIC® MIO® Clic

1590

A SP: max. 2 col.

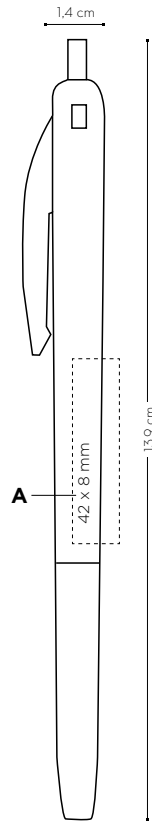

Price (€)

BIC® MIO® Clic	500-499	1000-2499	2500-4999	5000-9999	10000-24999	25000-49999
1590						
SP	0,52	0,50	0,47	0,44	0,41	0,37

ADDITIONAL IMPRINT CHARGE PER COLOUR & POSITION frais d'impression supplémentaires par couleur et position / cargo por impresión adicional por color y posición / zusätzliche druckkosten pro farbe & position / costo marchio aggiuntivo per colore e posizione

SP	0,13	0,13	0,13	0,12	0,11	0,11
-----------	------	------	------	------	------	------

Prices include 1 colour screenprint in one position. Les prix incluent la sérigraphie 1 couleur sur un emplacement. En precio incluye un color en serigrafía en una posición. In den Preisen inbegriffen ist 1 Siebdruck-Farbaufdruck auf 1 Position. I prezzi includono 1 colore a serigrafia in una posizione.

Writing modes:

Mode écriture / Modos de escritura / Schreibmodi / Modalità di scrittura

Ballpen



M

Printing techniques:

Techniques d'impression / Técnicas de impresión / Drucktechniken / Tecniche di stampa



(SP) SCREEN PRINTING

External packaging:

Emballage externe / Envasado exterior / Außenverpackung / Imballaggio esterno



1000 ± 8 Kg

Check out the video

Regardez la video / Mira el video / Produktvideo / Guarda il video



MADE IN FRANCE



White colour
MADE IN SAF

Media Clic

The promotional writing instrument of excellence, our number one, the original. Multiple printing possibilities on the barrel and on the clip in up to 4 colours, and thousands of colour combinations for maximum personalisation!



FR > L'outil d'écriture publicitaire par excellence, notre numéro un, l'original. De nombreuses possibilités d'imprimer jusqu'à 4 couleurs sur le corps et sur le clip, et des milliers de combinaisons de teintes pour une personnalisation maximale!

DE > Das Schreibgerät par excellence unter den Werbegeschenken, die Nummer Eins unserer Kunden, das Original. Vielfältige Druckmöglichkeiten auf Schaft und Clip in bis zu 4 Farben und tausende von Farbkombinationen für maximale Personalisierung!

ES > El instrumento de escritura promocional por excelencia, nuestro número uno, el original. ¡Múltiples posibilidades de impresión en el cuerpo y en el clip hasta 4 colores, y miles de combinaciones de colores para una máxima personalización!

IT > Lo strumento di scrittura promozionale per eccellenza, il nostro numero uno, l'originale. Molteplici possibilità di stampa sul corpo e sulla clip fino a 4 colori e migliaia di combinazioni di colore per la massima personalizzazione!





POLISHED BALLPEN - 1025



Iconic BIC® Boy is embossed

BIC® WRITING INSTRUMENTS

BALLPENS



1T 8T 6P 3T 9T 5P 5T 4T 7T 8L 2T

Colour ink
Encre de couleur
Color de la tinta
Schreibfarbe
Colore inchiostro



Red Ink available under request
Encre rouge disponible sur demande
Tinta roja bajo consulta
Rote Tinte auf Anfrage erhältlich
Inchiostro rosso disponibile su richiesta

6T 100%



*48h not available in Digital finishes
*48h non disponibile en impression numérique / *48h no disponible en acabados digitales / *48h bei digitalen Ausführungen nicht erhältlich / *48h non disponibile in finiture digitali



CLEAR BALLPEN - 1025



More than 10000 clicks!

BALLPENS
BIC® WRITING INSTRUMENTS

FR > Plus de 10 000 clics !

ES > ¡Más de 10000 clics!

DE > Mehr als 10000 Klicks!

IT > Più di 10.000 clic!





OPAQUE BALLPEN - 1025 / PENCIL 1028

BIC® WRITING INSTRUMENTS

BALLPENS

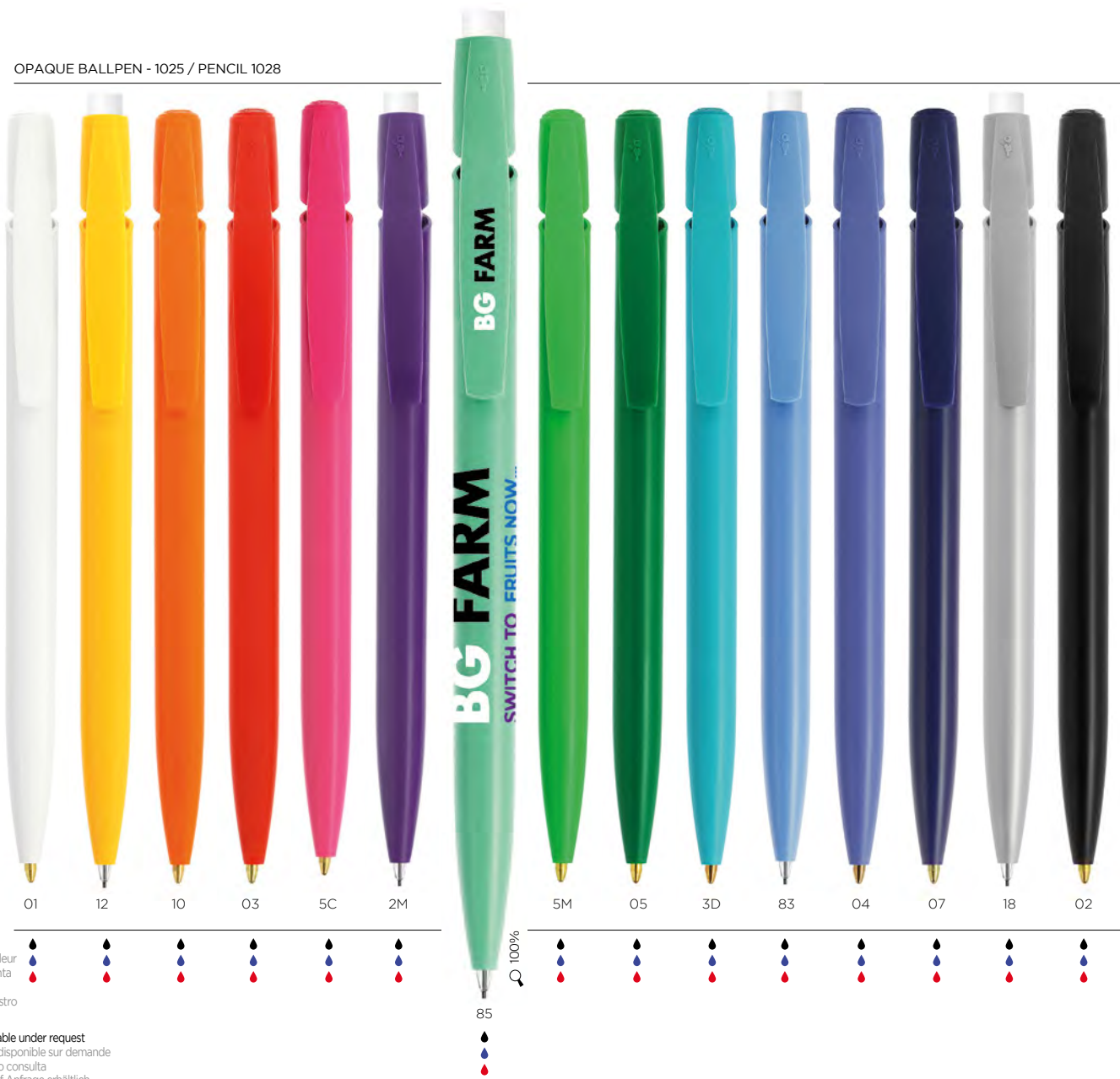

Colour ink
Encre de couleur
Color de la tinta
Schreibfarbe
Colore inchiostro

Red Ink available under request
Encre rouge disponible sur demande
Tinta roja bajo consulta
Rote Tinte auf Anfrage erhältlich
Inchiostro rosso disponibile su richiesta



*48h not available in Digital finishes
*48h non disponibile en impression numérique / *48h no disponible en acabados digitales / *48h bei digitalen Ausführungen nicht erhältlich / *48h non disponibile in finiture digitali



FROSTED BALLPEN - 1025 / PENCIL 1028

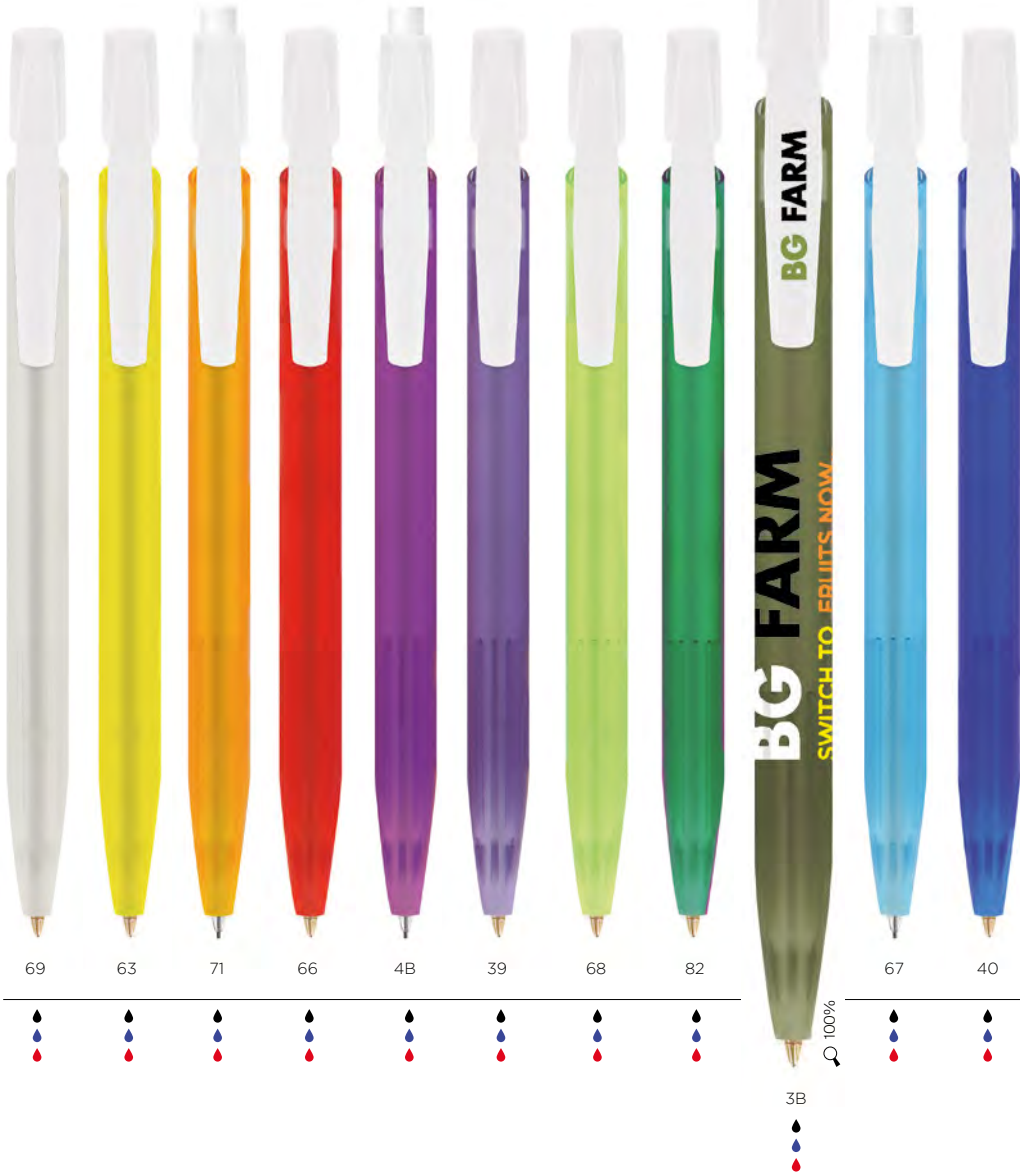

BALLPENS
BIC® WRITING INSTRUMENTS





Grip



OPAQUE BALLPEN - 1020
PENCIL 1021

FROSTED BALLPEN - 1020 / PENCIL 1021

BIC® WRITING INSTRUMENTS

BALLPENS



Colour ink
Encre de couleur
Color de la tinta
Schreibfarbe
Colore inchiostro

Red Ink available under request
Encre rouge disponible sur demande
Tinta roja bajo consulta
Rote Tinte auf Anfrage erhältlich
Inchiostro rosso disponibile su richiesta



*48h not available in Digital finishes
*48h non disponibile en impression numérique / *48h no disponible en acabados digitales / *48h bei digitalen Ausführungen nicht erhältlich / *48h non disponibile in finiture digitali



ecolutions®

OPAQUE BALLPEN - 1E20
PENCIL 1E21



01/12

01/03

01/05

01/02



01/07



Digital Printing!

BIC® Media Clic Digital

OPAQUE BALLPEN - 1025
PENCIL 1028

BIC® Media Clic Grip Digital

OPAQUE BALLPEN - 1020 / 1E20
PENCIL 1021 / 1E21



01

01/05

01/12



Only available in white barrel
Disponible en corps blanc
Solo disponible en cuerpo blanco
Mit weißem Schaft erhältlich
Disponibile solo in fusto bianco

01



Only available in white barrel
Disponible en corps blanc
Solo disponible en cuerpo blanco
Mit weißem Schaft erhältlich
Disponibile solo in fusto bianco

01/12



Check out the video

Regardez la vidéo / Mira el vídeo /
Produktvideo / Guarda il video



MOQ 500v.

Standard colours combination

Combinaison de couleurs standards / Combinación de colores estandar / Standardfarbkombination / Combinazione colori standard

Plug

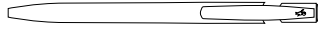

Bouton / Botón / Endstück / Pulsante

OPAQUE 01 12 10 03 5C 2D 13 84 85 5M 05 3D 83 04 07 29 2B 18 02 FROSTED 69

Clip

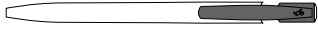

Clip / Clip / Clip / Clip

OPAQUE 01 12 10 03 5C 2D 13 84 85 5M 05 3D 83 04 07 29 2B 18 02 FROSTED 69

Barrel



Corps / Cuerpo / Schaft / Fusto

OPAQUE 01 8D 12 10 03 5C 2M 85 5M 05 3D 83 04 07 3C 18 02 BARREL & GRIP 01/12 01/03 01/05 01/07 01/02

FROSTED 69 63 71 66 4B 39 68 82 67 40 3B BARREL & GRIP 01/69 69/69 71/69 66/69 82/69 40/69

POLISHED 1T 8T 6P 3T 6T 9T 5P 5T 4T 7T 8L 2T

CLEAR 1R 4D 92 87 95 93 88 72 4R 7R 91

Exact colour match:

Correspondance exacte des couleurs / Color exacto / Exakte Farbübereinstimmung / Esatta corrispondenza di colore

≥ 10.000 units 1025/1028

≥ 20.000 units 1020/1021

Writing modes:

Mode écriture / Modos de escritura / Schreibmodi / Modalità di scrittura

Ballpen



M

Mechanical pencil



MPØ0,7mm

Printing techniques:

Techniques d'impression / Técnicas de impresión / Drucktechniken / Tecniche di stampa



(SP) SCREEN PRINTING



(DG) DIGITAL



(LE) LASER

MOA 500v.

@CColutions® standard colours combination

Combinaison de couleurs standards / Combinación de colores estandar / Standardfarbcombination / Combinazione colori standard

Plug

Bouton / Botón / Endstück / Pulsante



Clip

Clip / Clip / Clip / Clip

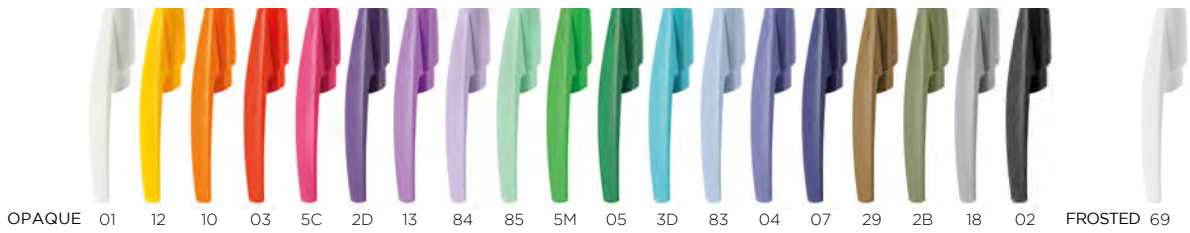

Barrel

Corps / Cuerpo / Schaft / Fusto

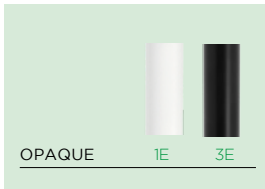

OPAQUE

1E

3E



@CColutions® Made with 39% recycled material.
The percentage is calculated based on the total weight of the product.
Add the Möbius loop to your artwork at no additional charge. Please be sure to specify "Print the Möbius loop" on your order. (Möbius loop imprint defaults to left-hand hand corner.)



BARREL & GRIP

01/12 01/03 01/05 01/07 01/02



@CColutions® Made with 37% recycled material.
The percentage is calculated based on the total weight of the product.

FR > Le pourcentage est calculé sur le poids total du produit.
Ajoutez l'anneau Möbius à votre article sans frais supplémentaire. N'oubliez pas de préciser « Imprimer l'anneau Möbius » dans votre commande. (L'anneau Möbius est imprimé par défaut dans le coin supérieur gauche)

ES > El porcentaje está calculado basado en el peso total del producto.
Añade el Möbius loop a tu arte final sin cargo adicional. Por favor asegúrate de especificar "imprimir el Möbius loop" en tu pedido. (La impresión del Möbius loop a mano izquierda en la esquina)

DE > Der Prozentsatz ist auf der Grundlage des Gesamtgewichts des Produkts berechnet.
Zu Artwork Möbius-Loop hinzufügen, ohne Zusatzkosten.
Vergessen Sie nicht "Möbius-Loop drucken" auf der Bestellung anzugeben (Möbius-Loop-Druck standardmäßig auf der linken Ecke).

IT > La percentuale è calcolata in base al peso totale del prodotto.
Aggiungi l'anello di Möbius al tuo disegno senza costi aggiuntivi. Assicurati di specificare "Stampare anello di Möbius" nel tuo ordine. (La stampa dell'anello di Möbius va in default nell'angolo sinistro)

Exact colour match:

Correspondance exacte des couleurs / Color exacto / Exakte Farbübereinstimmung / Esatta corrispondenza di colore

≥ 10.000 units

1E25/1E28
1E20/1E21

≥ 20.000 units

1E20 digital/1E21 digital

Writing modes:

Mode écriture / Modos de escritura / Schreibmodi / Modalità di scrittura

Ballpen



M

Mechanical pencil



MPØ0,7mm

Printing techniques:

Techniques d'impression / Técnicas de impresión / Drucktechniken / Tecniche di stampa



(SP) SCREEN PRINTING



(DG) DIGITAL



(LE) LASER

Decoration:

Personalisation / Personalización / Dekoration / Decorazione

BIC® Media Clic

- 1025 (ballpen)
- 1028 (pencil)
- ©©©olutions® 1E25 (ballpen)
- ©©©olutions® 1E28 (pencil)
- A SP:** max. 4 col.
- B SP:** max. 2 col.
- C DG:** full-colour

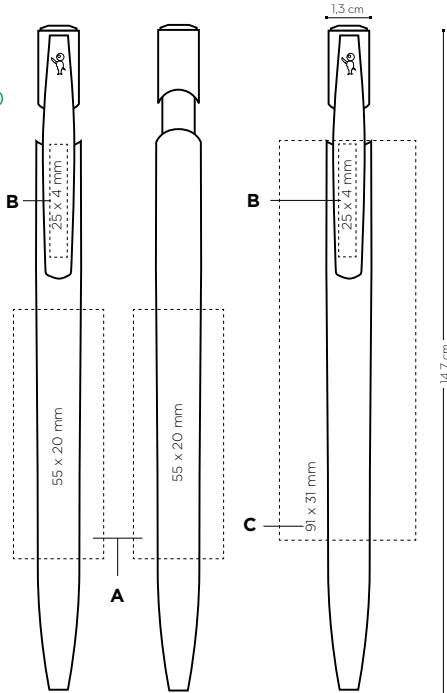

BIC® Media Clic Grip

- 1020 (ballpen)
- 1021 (pencil)
- ©©©olutions® 1E20 (ballpen)
- ©©©olutions® 1E21 (pencil)
- D SP:** max. 4 col.
- E SP:** max. 2 col.
- F DG:** full-colour

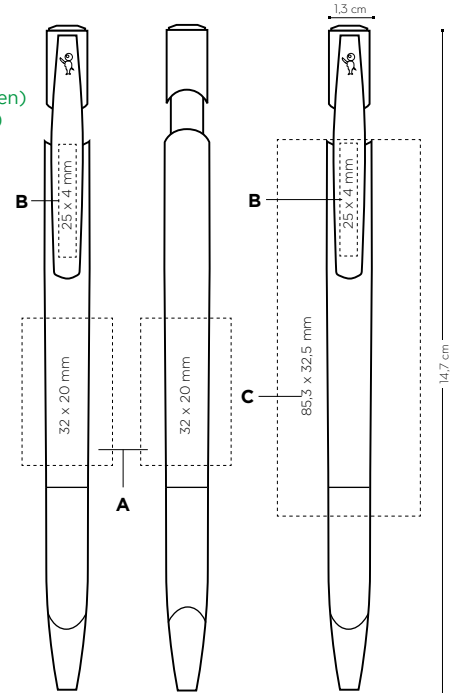

BIC® WRITING INSTRUMENTS
BALLPENS

	Price (€)					
BIC® Media Clic	500-499	1000-2499	2500-4999	5000-9999	10000-24999	25000-49999
1025 (ballpen)						
SP	0.60	0.56	0.52	0.48	0.45	0.42
DG	0.82	0.77	0.71	0.67	①	①
1028 (pencil)						
SP	0.78	0.73	0.68	0.64	0.60	0.56
DG	0.92	0.86	0.80	0.76	①	①
©©©olutions® 1E25 (ballpen)						
SP	0.65	0.60	0.56	0.53	①	①
©©©olutions® 1E28 (pencil)						
SP	0.86	0.80	0.74	0.70	①	①

ADDITIONAL IMPRINT CHARGE PER COLOUR & POSITION frais d'impression supplémentaires par couleur et position / cargo por impresión adicional por color y posición / zusätzliche druckkosten pro farbe & position / costo marchio aggiuntivo per colore e posizione

SP	0,13	0,13	0,13	0,12	0,11	0,11
-----------	------	------	------	------	------	------

Prices include one imprint in one position according to specified technique. Les prix incluent une impression sur un emplacement avec la technique spécifiée / Los precios incluyen una impresión en una posición acorde con la técnica especificada / In den Preisen inbegriffen ist ein Aufdruck auf einer Position gemäß angegebener Technik / I prezzi includono una stampa in una posizione a seconda della tecnica specificata.

① Price under request. Prix sur demande. Precio bajo consulta. Preis auf Anfrage. Prezzi su richiesta.

	Price (€)					
BIC® Media Clic Grip	500-499	1000-2499	2500-4999	5000-9999	10000-24999	25000-49999
1020 (ballpen)						
SP	0.90	0.84	0.79	0.73	0.68	0.63
DG	1.12	1.05	0.98	0.92	①	①
1021 (pencil)						
SP	1.00	0.93	0.87	0.82	0.76	0.71
DG	1.22	1.14	1.06	1.01	①	①
©©©olutions® 1E20 (ballpen)						
SP	1.00	0.93	0.87	0.82	①	①
DG	1.22	1.14	1.06	1.01	①	①
©©©olutions® 1E21 (pencil)						
SP	1.08	1.01	0.94	0.89	①	①
DG	1.30	1.22	1.13	1.08	①	①

ADDITIONAL IMPRINT CHARGE PER COLOUR & POSITION frais d'impression supplémentaires par couleur et position / cargo por impresión adicional por color y posición / zusätzliche druckkosten pro farbe & position / costo marchio aggiuntivo per colore e posizione

SP	0,13	0,13	0,13	0,12	0,11	0,11
-----------	------	------	------	------	------	------

Prices include one imprint in one position according to specified technique. Les prix incluent une impression sur un emplacement avec la technique spécifiée / Los precios incluyen una impresión en una posición acorde con la técnica especificada / In den Preisen inbegriffen ist ein Aufdruck auf einer Position gemäß angegebener Technik / I prezzi includono una stampa in una posizione a seconda della tecnica specificata.

① Price under request. Prix sur demande. Precio bajo consulta. Preis auf Anfrage. Prezzi su richiesta.

External packaging:

Emballage externe / Envasado exterior / Außenverpackung / Imballaggio esterno



500 ± 4,1 Kg

External packaging:

Emballage externe / Envasado exterior / Außenverpackung / Imballaggio esterno



500 ± 4,3 Kg

Check out the video

Regardez la video / Mira el video / Produktvideo / Guarda il video



MADE IN SPAIN

BIC® Media Clic Premium
OPAQUE BALLPEN - 1D25



Colour ink
Encre de couleur
Color de la tinta
Schreibfarbe
Colore inchiostro

4A

5A

7A
100%

8A

Red ink available under request
Encre rouge disponible sur demande
Tinta roja bajo consulta
Rote Tinte auf Anfrage erhältlich
Inchiostro rosso disponibile su richiesta

BIC® Media Clic Premium

1D25

A SP: max. 4 col.

B SP: max. 1 col.

C LE

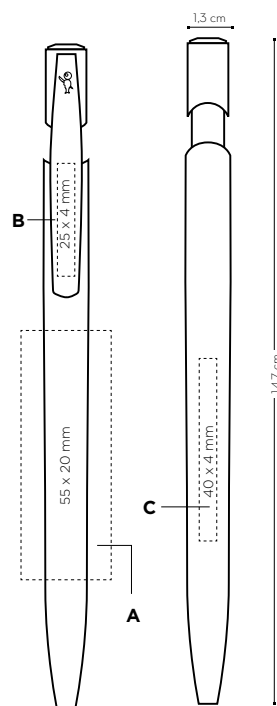

MOQ 500v.

Standard colours combination

Combinaison de couleurs standards / Combinación de colores estandar / Standardfarbkombination / Combinazione colori standard

Plug

Bouton / Botón / Endstück / Pulsante

PREMIUM 35

Clip

Clip / Clip / Clip / Clip



PREMIUM 4A 5A*

Barrel

Corps / Cuerpo / Schaft / Fusto

PREMIUM

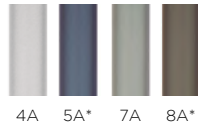

4A 5A* 7A 8A*

Price (€)

BIC® Media Clic Premium 250-499 500-999 1000-2499 2500-4999 5000-9999 10000-24999 25000-49999

1D25

SP	1,49	1,35	1,25	1,16	1,09	1,01	0,95
LE	2,54	2,31	2,08	1,99	1,93	1,86	1,80

ADDITIONAL IMPRINT CHARGE PER COLOUR & POSITION frais d'impression supplémentaires par couleur et position / cargo por impresión adicional por color y posición / zusätzliche druckkosten pro farbe & position / costo marchio aggiuntivo per colore e posizione

SP	0,16	0,13	0,13	0,13	0,12	0,11	0,11
LE	1,21	1,09	0,96	0,96	0,96	0,96	0,96

Prices include one imprint in one position according to specified technique. Les prix incluent une impression sur un emplacement avec la technique spécifiée / Los precios incluyen una impresión en una posición acorde con la técnica especificada / In den Preisen inbegriffen ist ein Aufdruck auf einer Position gemäß angegebener Technik / I prezzi includono una stampa in una posizione a seconda della tecnica specificata.

Writing modes:

Mode écriture / Modos de escritura / Schreibmodi / Modalità di scrittura



M

Printing techniques:

Techniques d'impression / Técnicas de impresión / Drucktechniken / Tecniche di stampa



(SP) SCREEN PRINTING



(LE) LASER

External packaging:

Emballage externe / Envasado exterior / Außenverpackung / Imballaggio esterno



500 ± 3,7 Kg



*until stock lasts

Jusqu'à épuisement du stock / Hasta que se acabe el stock / Solange der Vorrat reicht / Fino a esaurimento scorte

www.bicgraphic.eu 69

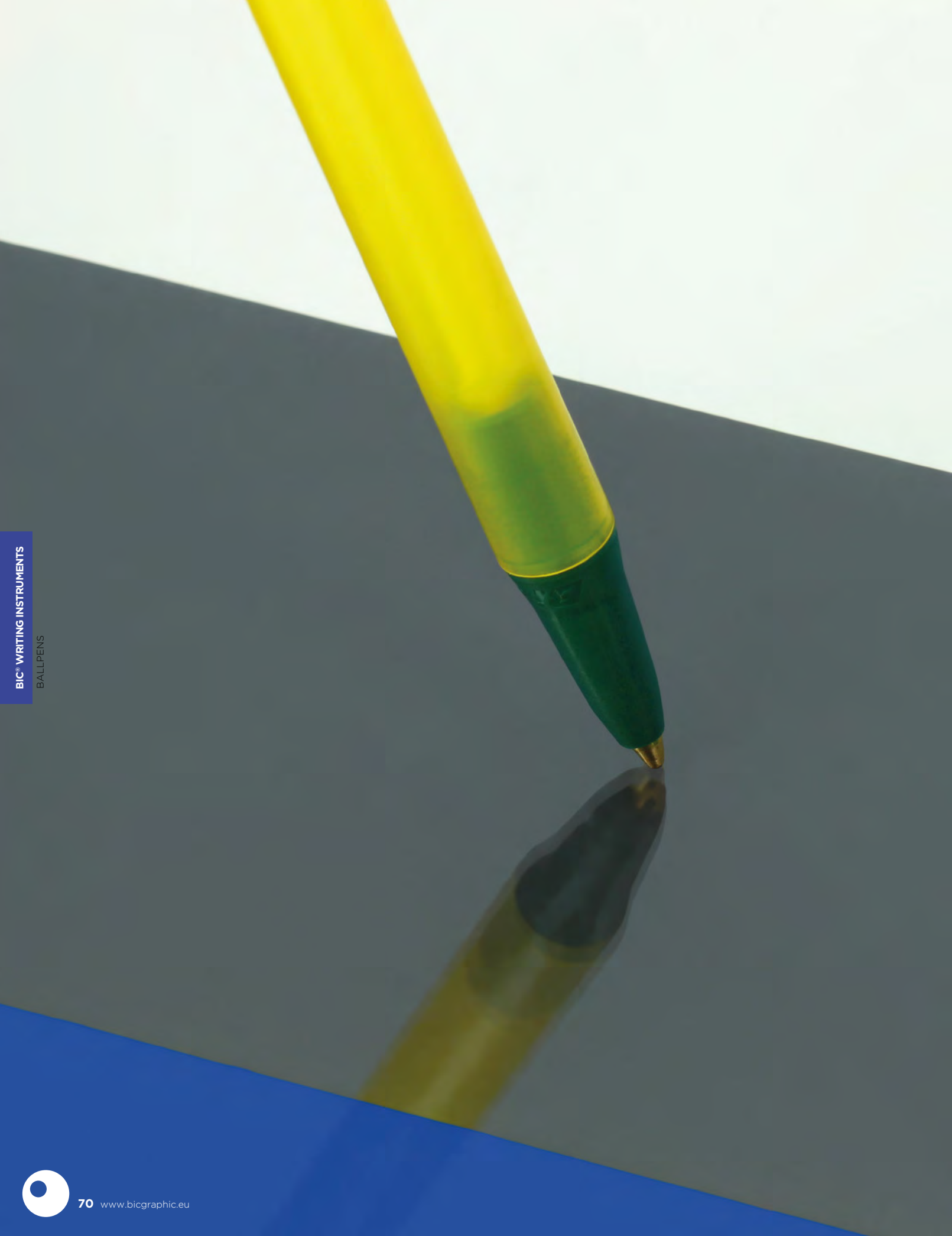

BIC® WRITING INSTRUMENTS

BALLPENS





Modern, flexible, reliable. That's how BIC® Clic Stic is!
A large variety of finishes such as Digital, Stylus, Softfeel®
or Mini, and thousands of colour combinations!

FR > Moderne, fiable, flexible.
C'est la définition même du BIC®
Clic Stic! Une grande variété de
finitions telles que Digital, Stylus,
Softfeel® ou Mini, et plus de mille
combinaisons de couleurs!

ES > Moderno, flexible, fiable. ¡Así
es BIC® Clic Stic! Amplia variedad
de acabados, como Digital,
Stylus, Softfeel® o Mini y miles de
combinaciones de colores!

DE > Modern, flexibel, zuverlässig.
So ist BIC® Clic Stic! In einer
großen Vielfalt von Oberflächen
wie Digital, Stylus, Softfeel®
oder Mini und tausenden von
Farbkombinationen erhältlich!

IT > Moderna, flessibile, affidabile.
Ecco com'è BIC® Clic Stic! Una
grande varietà di rifiniture come
Digital, Stylus, Softfeel® o Mini,
e migliaia di combinazioni di
colore!



BALLPENS
BIC® WRITING INSTRUMENTS





MIX & MATCH



OPAQUE - 1000



01 12 03 05 07 18 02

Colour ink
Encre de couleur
Color de la tinta
Schreibfarbe
Colore inchiostro

Red Ink available under request
Encre rouge disponible sur demande
Tinta roja bajo consulta
Rote Tinte auf Anfrage erhältlich
Inchiostro rosso disponibile su richiesta

100%
04

Iconic BIC® Boy is embossed

ecolutions®
OPAQUE - 1E00



1E/8E 1E/7E 1E/3E

100%
1E/10E



FROSTED - 1000

Break resistant clip!



ecolutions®
FROSTED - 1E00



BIC® clic stic Mini
OPAQUE - 1892



BALLPENS
BIC® WRITING INSTRUMENTS

FR > Clip résistant incassable !

ES > iClip irrompibile!

DE > Bruchsicherer Clip!

IT > Clip indistruttibile!





BIC® Clic Stic softfeel®
OPAQUE - 1005

FROSTED - 1005

BIC® Clic Stic stylus
OPAQUE - 1847



Colour ink
Encre de couleur
Color de la tinta
Schreibfarbe
Colore inchiostro

Red Ink available under request
Encre rouge disponible sur demande
Tinta roja bajo consulta
Rote Tinte auf Anfrage erhältlich
Inchiostro rosso disponibile su richiesta

BIC® WRITING INSTRUMENTS
BALLPENS



*48h not available in Digital finishes
*48h non disponible en impression numerique / *48h non disponible en acabados digitales / *48h bei digitalen Ausführungen nicht erhältlich / *48h non disponibile in finiture digitali

Digital Printing!

BIC® Clic Stic
Digital
OPAQUE - 1000



01



100%

BIC® Clic Stic
Mini Digital
OPAQUE - 1892



01



100%

BIC® Clic Stic
Stylus Digital
OPAQUE - 1847



01



100%



Only available in white barrel
Disponible en corps blanc
Solo disponible en cuerpo blanco
Mit weißem Schaft erhältlich
Disponibile solo in fusto bianco



MOQ 500v.

Standard colours combination

Combinaison de couleurs standards / Combinación de colores estandar / Standardfarbkombination / Combinazione colori standard

Plug

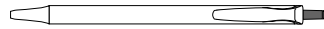

Bouton / Botón / Endstück / Pulsante

OPAQUE	01	12	10	03	05	20	04	07	18	02	FROSTED	69	63	71	66	68	67	40
--------	----	----	----	----	----	----	----	----	----	----	---------	----	----	----	----	----	----	----

Clip



Clip / Clip / Clip / Clip

OPAQUE	01	12	10	03	05	20	04	07	18	02	FROSTED	69	63	71	66	68	67	40
--------	----	----	----	----	----	----	----	----	----	----	---------	----	----	----	----	----	----	----

Section

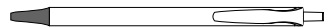

Section / Sección / Teil / Sezione

OPAQUE	01	12	10	03	05	20	04	07	18	02
--------	----	----	----	----	----	----	----	----	----	----

STYLUS

FROSTED	69	63	71	66	68	67	40	OPAQUE	02
---------	----	----	----	----	----	----	----	--------	----

Barrel



Corps / Cuerpo / Schaft / Fusto

OPAQUE	01	12	03	05	04	07	18	02
--------	----	----	----	----	----	----	----	----

SOFTFEEL®

OPAQUE	20	07	02
--------	----	----	----

MINI

OPAQUE	01
--------	----

SOFTFEEL®

FROSTED	69	63	66	68	67	40	71	OPAQUE	40
---------	----	----	----	----	----	----	----	--------	----

Exact colour match:

Correspondance exacte des couleurs / Color exacto / Exakte Farbübereinstimmung / Esatta corrispondenza di colore

≥ 10.000 units

Writing modes:

Mode écriture / Modos de escritura / Schreibmodi / Modalità di scrittura



M

Printing techniques:

Techniques d'impression / Técnicas de impresión / Drucktechniken / Tecniche di stampa



(SP) SCREEN PRINTING



(DG) DIGITAL

MOA 500v.

ecolutions® standard colours combination

Combinaison de couleurs standards / Combinación de colores estandar / Standardfarbkombination / Combinazione colori standard

Plug

Bouton / Botón / Endstück / Pulsante

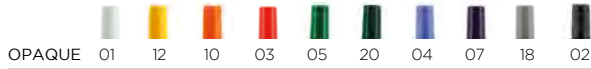
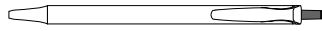

Clip

Clip / Clip / Clip / Clip

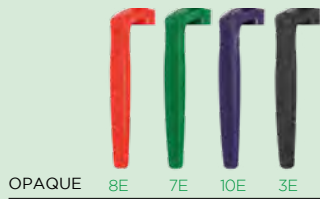
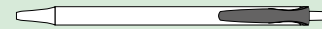

Section

Section / Sección / Teil / Sezione



Barrel

Corps / Cuerpo / Schaft / Fusto

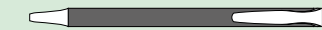

ecolutions® Made with 58% recycled material.

The percentage is calculated based on the total weight of the product.

Add the Möbius loop to your artwork at no additional charge. Please be sure to specify "Print the Möbius loop" on your order. (Möbius loop imprint defaults to left-hand hand corner.)

FR > Le pourcentage est calculé sur le poids total du produit.

Ajoutez l'anneau Möbius à votre article sans frais supplémentaire. N'oubliez pas de préciser « Imprimer l'anneau Möbius » dans votre commande. (L'anneau Möbius est imprimé par défaut dans le coin supérieur gauche.)

ES > El porcentaje está calculado basado en el peso total del producto.

Añade el Möbius loop a tu arte final sin cargo adicional. Por favor asegúrate de especificar "imprimir el Möbius loop" en tu pedido. (La impresión del Möbius loop a mano izquierda en la esquina.)

DE > Der Prozentsatz ist auf der Grundlage des Gesamtgewichts des Produkts berechnet.

Zu Artwork Möbius-Loop hinzufügen, ohne Zusatzkosten. Vergessen Sie nicht "Möbius-Loop drucken" auf der Bestellung anzugeben (Möbius-Loop-Aufdruck standardmäßig auf der linken Ecke).

IT > La percentuale è calcolata in base al peso totale del prodotto.

Aggiungi l'anello di Möbius al tuo disegno senza costi aggiuntivi. Assicurati di specificare "Stampare anello di Möbius" nel tuo ordine. (La stampa dell'anello di Möbius va in default nell'angolo sinistro.)

Exact colour match:

Correspondance exacte des couleurs / Color exacto / Exakte Farbübereinstimmung / Esatta corrispondenza di colore

≥ 10.000 units

Writing modes:

Mode écriture / Modos de escritura / Schreibmodi / Modalità di scrittura

Ballpen



M

Printing techniques:

Techniques d'impression / Técnicas de impresión / Drucktechniken / Tecniche di stampa



(SP) SCREEN PRINTING



(DG) DIGITAL



Decoration:

Personalisation / Personalización /
Dekoration / Decorazione

BIC® Clic Stic
1000
eCOlutions® 1E00

BIC® Clic Stic Stylus
1847

- A SP:** max. 3 col.
- B SP:** max. 1 col.
- C SP:** max. 2 col.
- D DG:** full-colour (area for text)
(available in white barrel)
- E DG:** full-colour (area for images)
(available in white barrel)

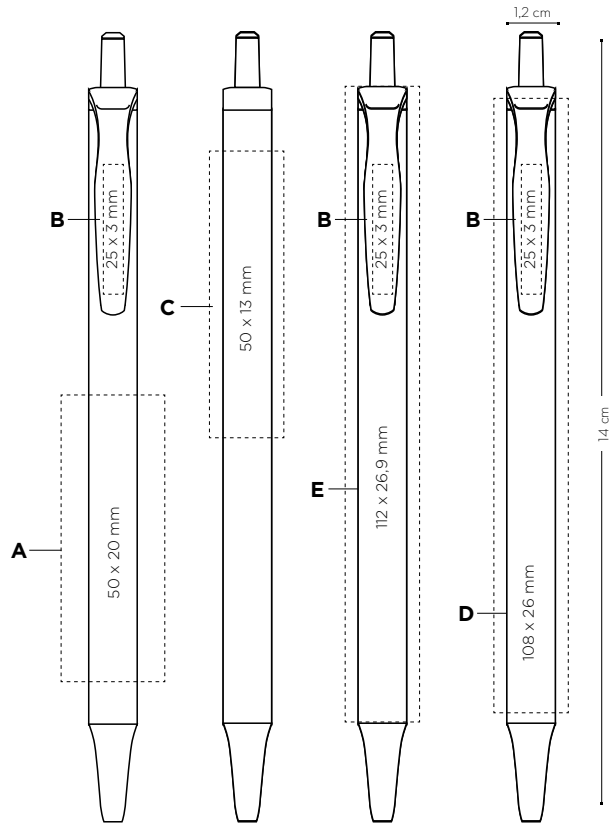

Price (€)

BIC® Clic Stic	500-444	1000-2444	2500-4444	5000-4444	10000-24444	25000-44444
1000						
SP	0,74	0,69	0,65	0,61	0,57	0,53
DG	0,98	0,91	0,85	0,80	Ⓜ	Ⓜ
eCOlutions® 1E00						
SP	0,82	0,75	0,70	0,66	Ⓜ	Ⓜ
DG	1,06	0,97	0,90	0,85	Ⓜ	Ⓜ
1847						
SP	0,88	0,82	0,77	0,72	Ⓜ	Ⓜ
DG	1,12	1,04	0,97	0,91	Ⓜ	Ⓜ

ADDITIONAL IMPRINT CHARGE PER COLOUR & POSITION frais d'impression supplémentaires par couleur et position / cargo por impresión adicional por color y posición / zusätzliche druckkosten pro farbe & position / costo marchio aggiuntivo per colore e posizione

SP 0,13 0,13 0,13 0,12 0,11 0,11

Prices include one imprint in one position according to specified technique. Les prix incluent une impression sur un emplacement avec la technique spécifiée / Los precios incluyen una impresión en una posición acorde con la técnica especificada / In den Preisen inbegriffen ist ein Aufdruck auf einer Position gemäß angegebener Technik / I prezzi includono una stampa in una posizione a seconda della tecnica specificata.

Ⓜ Price under request. Prix sur demande. Precio bajo consulta. Preis auf Anfrage. Prezzi su richiesta.

External packaging:

Emballage externe / Envasado exterior /
Außenverpackung / Imballaggio esterno



500 ± 2,9 Kg



MADE IN
SPAIN

BIC® Clic Stic softfeel®

1005

A/B SP: max. 1 col.

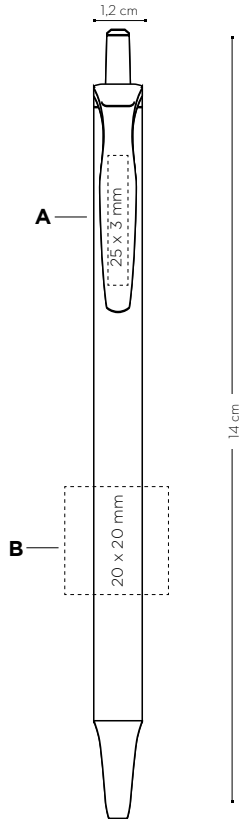

Price (€)

BIC® Clic Stic softfeel® 1005	500-499	1000-2499	2500-4999	5000-9999	10000-24999	25000-49999
SP	0,86	0,80	0,75	0,70	0,65	0,60

ADDITIONAL IMPRINT CHARGE PER COLOUR & POSITION frais d'impression supplémentaires par couleur et position / cargo por impresión adicional por color y posición / zusätzliche druckkosten pro farbe & position / costo marchio aggiuntivo per colore e posizione

SP	0,13	0,13	0,13	0,12	0,11	0,11
----	------	------	------	------	------	------

Prices include 1 colour screenprint in one position. Les prix incluent la sérigraphie 1 couleur sur un emplacement. En precio incluye un color en serigrafía en una posición. In den Preisen inbegriffen ist 1 Siebdruck-Farbaufdruck auf 1 Position. I prezzi includono 1 colore a serigrafia in una posizione.

external packaging:

Emballage externe / Envasado exterior / Außenverpackung / Imballaggio esterno



500 ± 2,9 Kg

BIC® Clic Stic mini

1892

A SP: max. 1 col.

B SP: max. 1 col.

C DG: full-colour (area for text)
(available in white barrel)

D DG: full-colour (area for images)
(available in white barrel)

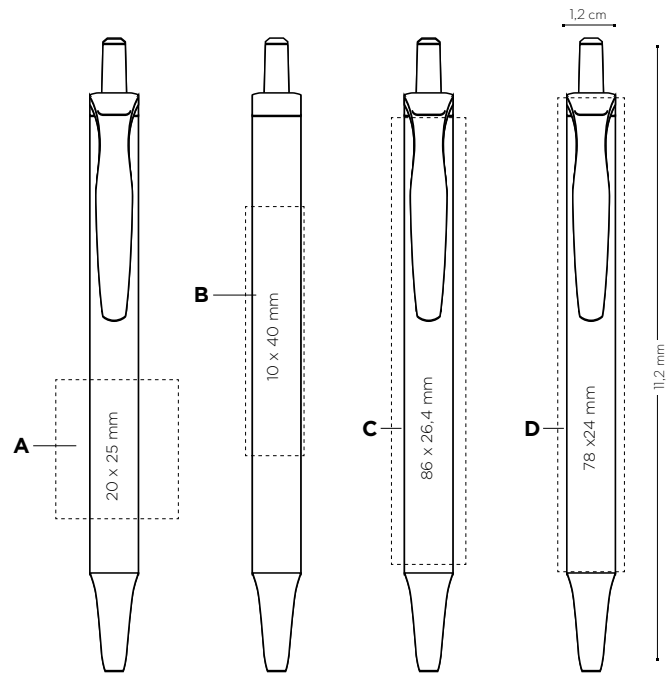

Price (€)

BIC® Clic Stic mini Digital 1892	500-499	1000-2499	2500-4999	5000-9999	10000-24999	25000-49999
SP	0,63	0,59	0,55	0,52	①	①
DG	0,90	0,84	0,78	0,74	①	①

Prices include one imprint in one position according to specified technique. Les prix incluent une impression sur un emplacement avec la technique spécifiée / Los precios incluyen una impresión en una posición acorde con la técnica especificada / In den Preisen inbegriffen ist ein Aufdruck auf einer Position gemäß angegebener Technik / I prezzi includono una stampa in una posizione a seconda della tecnica specificata.

① Price under request. Prix sur demande. Precio bajo consulta. Preis auf Anfrage. Prezzi su richiesta.

external packaging:

Emballage externe / Envasado exterior / Außenverpackung / Imballaggio esterno



500 ± 2,4 Kg



 **Super Clip**

Elegant & versatile design in a wide variety of colours.
Many customization possibilities in its XXL printing area.

FR > Design élégant et polyvalent, avec une grande variété de couleurs. De nombreuses possibilités de personnalisation avec sa zone d'impression XXL.

ES > Diseño elegante y versátil en gran variedad de colores. Muchas posibilidades de personalización en su XXL area de impresión.

DE > Elegantes, vielseitiges Design in einer Vielzahl Farben. Viele Möglichkeiten der Anpassung an Kundenwünsche auf der XXL-Druckfläche.

IT > Design elegante e versatile in un'ampia gamma di colori. Tantissime opzioni di personalizzazione nella sua area di stampa XXL.



BALLPENS
BIC® WRITING INSTRUMENTS





OPAQUE - 1039

BIC® WRITING INSTRUMENTS



Colour ink
Encre de couleur
Color de la tinta
Schreibfarbe
Colore inchiostro



*48h not available in Digital finishes
*48h non disponible en impression numérique / *48h no disponible en acabados digitales / *48h bei digitalen Ausführungen nicht erhältlich / *48h non disponibile in finiture digitali





eco^lutions®
OPAQUE
1E50



01/1E

CLEAR - 1039



51



92



87



95



93



88



100%



86



89



Digital Printing!

BIC® Super Clip Digital
OPAQUE - 1039



01



01



100%

Only available in white barrel
Disponible en corps blanc
Solo disponible en cuerpo blanco
Mit weißem Schaft erhältlich
Disponibile solo in fusto bianco



BALLPENS
BIC® WRITING INSTRUMENTS



MOA 250v.

Standard colours combination

Combinaison de couleurs standards / Combinación de colores estandar / Standardfarbcombination / Combinazione colori standard

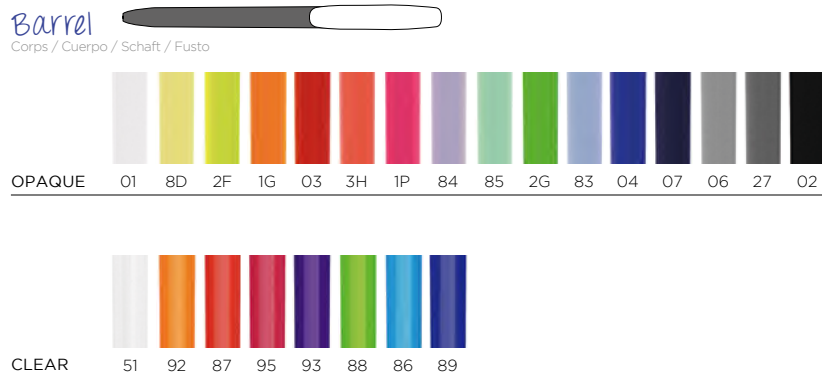
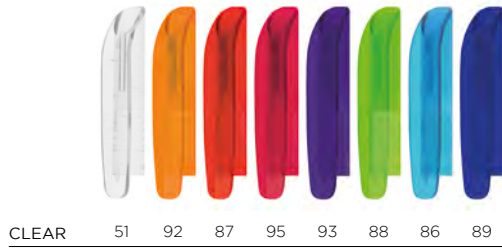
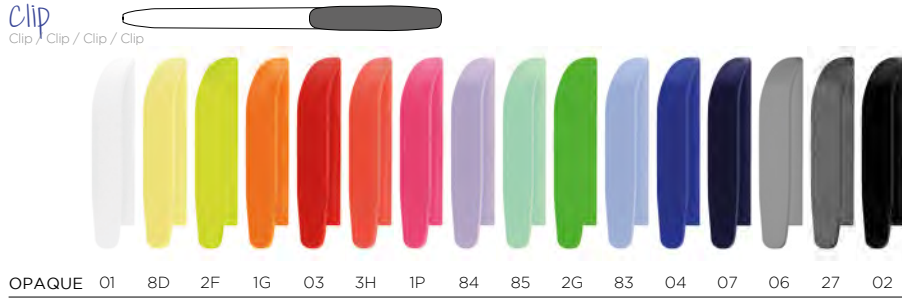

ecolutions® standard colours combination

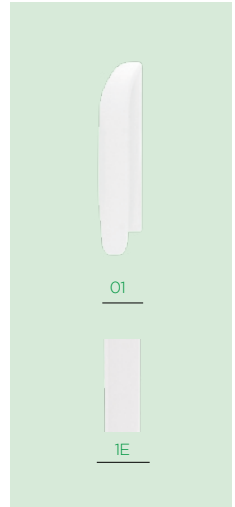

ecolutions® Made with 50% recycled material. The percentage is calculated based on the total weight of the product.

Add the Möbius loop to your artwork at no additional charge. Please be sure to specify "Print the Möbius loop" on your order. (Möbius loop imprint defaults to left-hand hand corner.)

FR > Le pourcentage est calculé sur le poids total du produit. Ajoutez l'anneau Möbius à votre article sans frais supplémentaire. N'oubliez pas de préciser « Imprimer l'anneau Möbius » dans votre commande. (L'anneau Möbius est imprimé par défaut dans le coin supérieur gauche)

ES > El porcentaje está calculado basado en el peso total del producto. Añade el Möbius loop a tu arte final sin cargo adicional. Por favor asegúrate de especificar "imprimir el Möbius loop" en tu pedido. (La impresión del Möbius loop a mano izquierda en la esquina)

DE > Der Prozentsatz ist auf der Grundlage des Gesamtgewichts des Produkts berechnet. Zu Artwork Möbius-Loop hinzufügen, ohne Zusatzkosten. Vergessen Sie nicht "Möbius-Loop drucken" auf der Bestellung anzugeben (Möbius-Loop-Aufdruck standardmäßig auf der linken Ecke).

IT > La percentuale è calcolata in base al peso totale del prodotto. Aggiungi l'anello di Möbius al tuo disegno senza costi aggiuntivi. Assicurati di specificare "Stampare anello di Möbius" nel tuo ordine. (La stampa dell'anello di Möbius va in default nell'angolo sinistro)

Exact colour match:

Correspondance exacte des couleurs / Color exacto / Exakte Farbübereinstimmung / Esatta corrispondenza di colore

≥ 10.000 units

Writing modes:

Mode écriture / Modos de escritura / Schreibmodi / Modalità di scrittura

Ballpen



M

Printing techniques:

Techniques d'impression / Técnicas de impresión / Drucktechniken / Tecniche di stampa



(SP) SCREEN PRINTING



(DG) DIGITAL



(BP) britePix™



External packaging:

Emballage externe / Envasado exterior / Außenverpackung / Imballaggio esterno



250 ± 2,6 Kg



MADE IN SPAIN

Decoration:

Personalisation / Personalización / Dekoration / Decorazione

BIC® Super Clip

1039

©©olutions® 1E50

A SP: max. 2 col.

B SP: max. 1 col.

C DG: full-colour

D BP: full-colour

BP Texture: full-colour

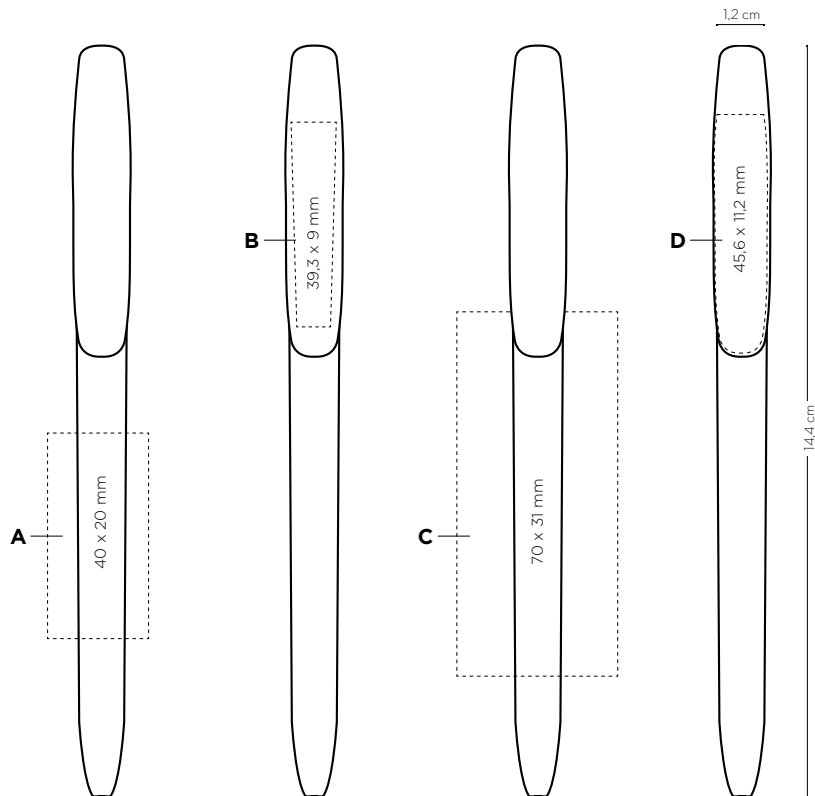

Price (€)

BIC® Super Clip	250-444	500-444	1000-2444	2500-4444	5000-4444	10000-24444	25000-44444
1039							
SP	1,01	0,97	0,93	0,90	0,87	0,84	0,81
DG	1,31	1,26	1,21	1,17	1,13	①	①
BP	1,27	1,21	1,16	1,11	1,07	1,03	0,99
©©olutions® 1E50							
SP	1,11	1,06	1,02	0,99	0,95	①	①
DG	1,41	1,35	1,30	1,26	1,21	①	①
BP	1,39	1,32	1,27	1,22	1,17	①	①

ADDITIONAL IMPRINT CHARGE PER COLOUR & POSITION frais d'impression supplémentaires par couleur et position / cargo per impresión adicional por color y posición / zusätzliche druckkosten pro farbe & position / costo marchio aggiuntivo per colore e posizione

SP	0,16	0,13	0,13	0,13	0,12	0,11	0,11
*BP Texture	0,17	0,15	0,14	0,14	0,13	0,12	0,12

Prices include one imprint in one position according to specified technique. Les prix incluent une impression sur un emplacement avec la technique spécifiée / Los precios incluyen una impresión en una posición acorde con la técnica especificada / In den Preisen inbegriffen ist ein Aufdruck auf einer Position gemäß angegebener Technik / I prezzi includono una stampa in una posizione a seconda della tecnica specificata.

① Price under request. Prix sur demande. Precio bajo consulta. Preis auf Anfrage. Prezzi su richiesta.

BIC Super Clip
Advance



MIX & MATCH



OPAQUE - 1073



Colour ink
Encre de couleur
Color de la tinta
Schreibfarbe
Colore inchiostro

01

2F

1G

03

3H

2G

04

1P



100%

metal section!

FR > Section en métal !

ES > ¡Sección metálica!

DE > Metallteil!

IT > Sezione in metallo!



*48h not available in Digital finishes
*48h non disponibile en impression numérique / *48h no disponible en acabados digitales / *48h bei digitalen Ausführungen nicht erhältlich / *48h non disponibile in finiture digitali





FR > Mécanisme pivotant silencieux !

ES > ¡Silencioso mecanismo giratorio!

DE > Leiser Drehmechanismus!!

IT > Meccanismo a rotazione silenzioso!

Digital Printing!

BIC® Super Clip Advance Digital
OPAQUE - 1073



Only available in white barrel
Disponibile en corps blanc
Solo disponible en cuerpo blanco
Mit weißem Schaft erhältlich
Disponibile solo in fusto bianco



Super Clip Advance

MOQ 2500.

Standard colours combination

Combinaison de couleurs standards / Combinación de colores estandar / Standardfarbkombination / Combinazione colori standard

Clip

Clip / Clip / Clip / Clip



OPAQUE 01 2F 1G 03 3H 1P 2G 04 07 06 27 02 CLEAR 51 92 87 95 93 88 86 89

Barrel

Corps / Cuerpo / Schaft / Fusto



OPAQUE 01 2F 1G 03 3H 1P 2G 04 07 06 27 02 CLEAR 51 92 87 95 93 88 86 89

Section

Section / Sección / Teil / Sezione

ADVANCE



35

Exact colour match:

Correspondance exacte des couleurs / Color exacto /
Exakte Farbübereinstimmung / Esatta corrispondenza di colore

≥ 10.000 units

Writing modes:

Mode écriture / Modos de escritura /
Schreibmodi / Modalità di scrittura

Ballpen



M

Printing techniques:

Techniques d'impression / Técnicas de impresión /
Drucktechniken / Tecniche di stampa



(SP) SCREEN
PRINTING



(DG) DIGITAL



(BP) britePix™



External packaging:

Emballage externe / Envasado exterior /
Außenverpackung / Imballaggio esterno



500 ± 3,9 Kg

Check out the video

Regardez la vidéo / Mira el vídeo /
Produktvideo / Guarda il video



MADE IN
SPAIN



Decoration:

Personalisation / Personalización / Dekoration / Decorazione

BIC® Super Clip Advance

1073

A SP: max. 2 col.

B SP: max. 1 col.

C DG: full-colour

D BP: full-colour

BP Texture: full-colour

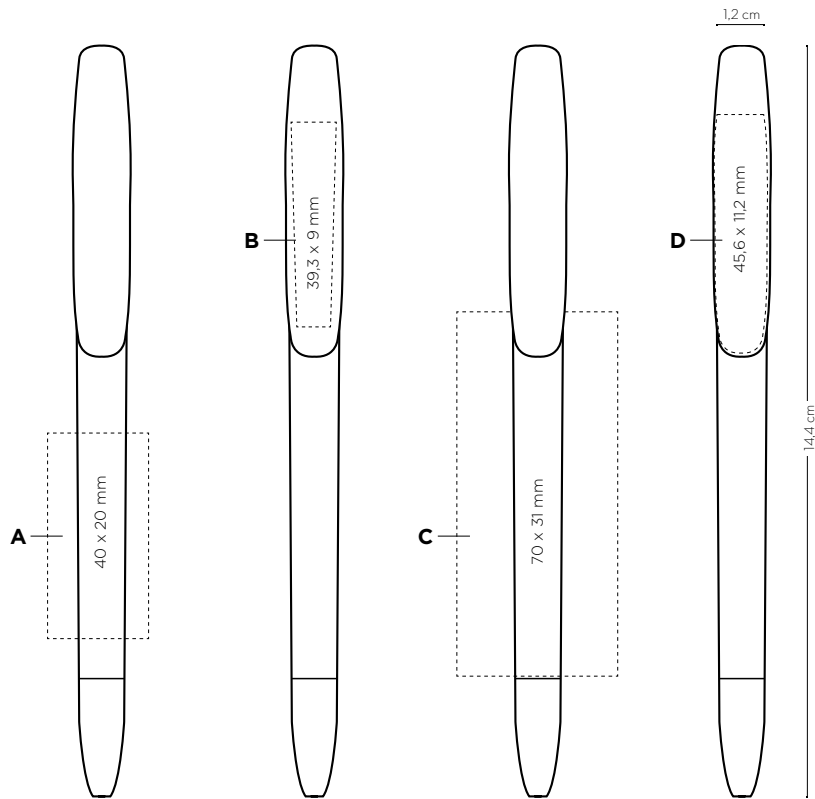

Price (€)

BIC® Super Clip Advance	250-499	500-999	1000-2499	2500-4999	5000-9999	10000-24999	25000-49999
1073							
SP	1,42	1,35	1,29	1,25	1,21	1,17	1,12
DG	1,72	1,64	1,57	1,52	1,47	①	①
BP	1,64	1,55	1,48	1,43	1,38	1,33	1,27

ADDITIONAL IMPRINT CHARGE PER COLOUR & POSITION frais d'impression supplémentaires par couleur et position / cargo por impresión adicional por color y posición / zusätzliche druckkosten pro farbe & position / costo marchio aggiuntivo per colore e posizione

SP	0,16	0,13	0,13	0,13	0,12	0,11	0,11
*BP Texture	0,17	0,15	0,14	0,14	0,13	0,12	0,12

Prices include one imprint in one position according to specified technique. Les prix incluent une impression sur un emplacement avec la technique spécifiée / Los precios incluyen una impresión en una posición acorde con la técnica especificada / In den Preisen inbegriffen ist ein Aufdruck auf einer Position gemäß angegebener Technik / I prezzi includono una stampa in una posizione a seconda della tecnica specificata.

① Price under request. Prix sur demande. Precio bajo consulta. Preis auf Anfrage. Prezzi su richiesta.



The right size for showing the true value of your brand!
Wide profile and wide variety of possibilities to maximise
your message.

FR > La taille idéale pour
montrer la vraie valeur de votre
marque ! Profil large et multiples
possibilités pour optimiser votre
communication.

ES > ¡El tamaño correcto para
enseñar el valor real de tu marca!
De perfil ancho y gran variedad
de posibilidades para maximizar
tu mensaje

DE > Die richtige Größe, um
den wahren Wert Ihrer Marke
zu zeigen! Breites Profil und
eine Vielzahl von Möglichkeiten,
Ihre Botschaft maximal zu
vermitteln.

IT > La giusta misura per mostrare
il vero valore del tuo marchio!
Ampio profilo e vasta gamma di
possibilità per ottimizzare il tuo
messaggio.





Iconic BIC® Boy is embossed

our biggest imprint area

OPAQUE - 1080

FROSTED - 1080



01

03

07

18

02

69

63

71

66

68

67

40

Colour ink
Encre de couleur
Color de la tinta
Schreibfarbe
Colore inchiostro

Red Ink available under request
Encre rouge disponible sur demande
Tinta roja bajo consulta
Rote Tinte auf Anfrage erhältlich
Inchiostro rosso disponibile su richiesta



FR > Notre plus grande zone d'impression !

ES > ¡Nuestra área de impresión más grande!

DE > Unsere größte Druckfläche!

IT > La nostra area di stampa più grande!



*48h not available in Digital finishes
*48h non disponibile en impression numérique / *48h non disponibile en acabados digitales / *48h bei digitalen Ausführungen nicht erhältlich / *48h non disponibile in finiture digitali



ecolutions®
OPAQUE - 1E80



1E

03

07

02

18



ecolutions®
FROSTED - 1E80



69

63

71

66

68

67

40



BIC® Wide Body™ Chrome



MIX & MATCH



BIC® Wide Body™ Chrome
OPAQUE - 1079

FROSTED - 1079



BIC® WRITING INSTRUMENTS

BALLPENS

Colour ink
Encre de couleur
Color de la tinta
Schreibfarbe
Colore inchiostro



Red Ink available under request
Encre rouge disponible sur demande
Tinta roja bajo consulta
Rote Tinte auf Anfrage erhältlich
Inchiostro rosso disponibile su richiesta



*48h not available in Digital finishes
*48h non disponibile in impression numérique / *48h non disponibile en acabados digitales / *48h bei digitalen Ausführungen nicht erhältlich / *48h non disponibile in finiture digitali



Digital Printing!

BIC® Wide Body™
Digital
OPAQUE - 1080



68



03



100%

BIC® Wide Body™
Mini Digital
OPAQUE - 1893



01



01



100%

Only available in white barrel
Disponible en corps blanc
Solo disponible en cuerpo blanco
Mit weißem Schaft erhältlich
Disponibile solo in fusto bianco

BIC® Wide Body™
Chrome Digital
OPAQUE - 1079

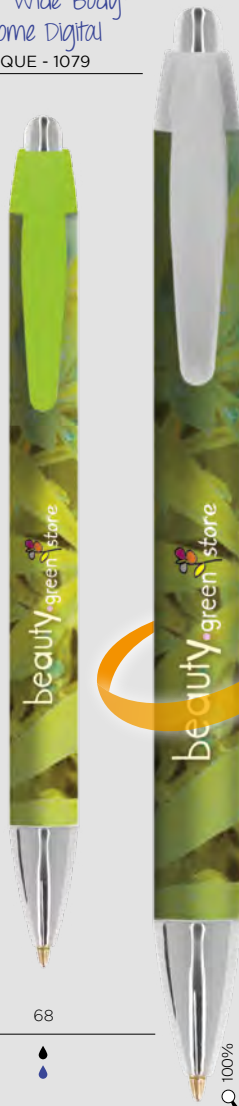

68



01



100%

BIC® Wide Body™
Chrome Mini Digital
OPAQUE - 1896



01



01



100%



MOQ 250v.

standard colours combination

Combinaison de couleurs standards / Combinación de colores estandar / Standardfarbkombination / Combinazione colori standard

Plug

Bouton / Botón / Endstück / Pulsante

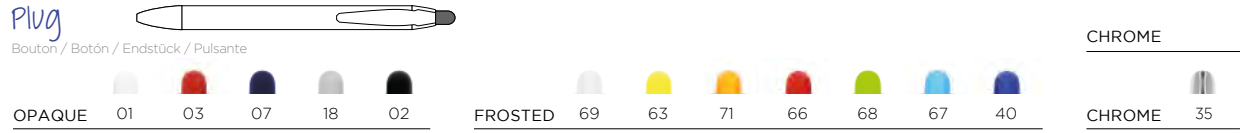

Clip

Clip / Clip / Clip / Clip

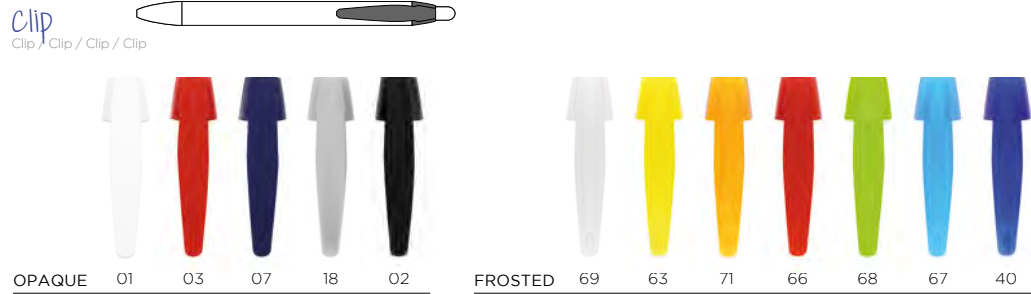

Barrel

Corps / Cuerpo / Schaft / Fusto

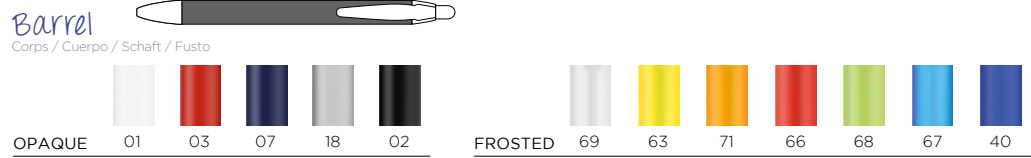

Section

Section / Sección / Teil / Sezione

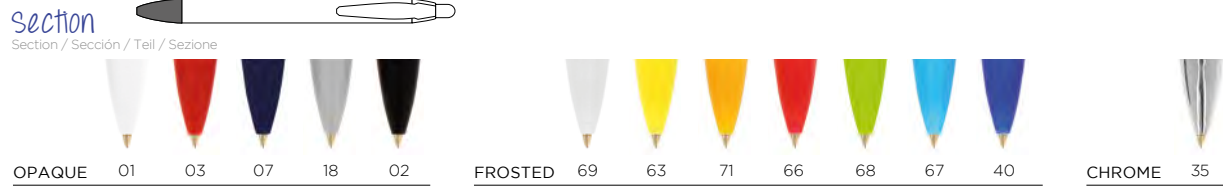

Exact colour match:

Correspondance exacte des couleurs / Color exacto / Exakte Farbübereinstimmung / Esatta corrispondenza di colore

≥ 10.000 units

≥ 25.000 units for custom made Section

Writing modes:

Mode écriture / Modos de escritura / Schreibmodi / Modalità di scrittura

Ballpen



M

Printing techniques:

Techniques d'impression / Técnicas de impresión / Drucktechniken / Tecniche di stampa



(SP) SCREEN PRINTING



(DG) DIGITAL

MOQ 250v.

©©olutions® standard colours combination

Combinaison de couleurs standards / Combinación de colores estandar / Standardfarbkombination / Combinazione colori standard

Part	Finish	Color Code
Plug Bouton / Botón / Endstück / Pulsante	OPAQUE	01
		03
		07
		18
		02
	FROSTED	69
		63
		71
		66
		40
Clip Clip / Clip / Clip / Clip	OPAQUE	01
		03
		07
		18
		02
	FROSTED	69
		63
		71
		66
		40
Barrel Corps / Cuerpo / Schaft / Fusto	OPAQUE	01
		03
		07
		18
		02
	FROSTED	69
		63
		71
		66
		40
Section Section / Sección / Teil / Sezione	OPAQUE	01
		03
		07
		18
		02
	FROSTED	69
		63
		71
		66
		40

Exact colour match:

Correspondance exacte des couleurs / Color exacto / Exakte Farbübereinstimmung / Esatta corrispondenza di colore

≥ 10.000 units

≥ 25.000 units for custom made Section



©©olutions® Made with 33% recycled material.

The percentage is calculated based on the total weight of the product.

Add the Möbius loop to your artwork at no additional charge. Please be sure to specify "Print the Möbius loop" on your order. (Möbius loop imprint defaults to left-hand hand corner.)

FR > Le pourcentage est calculé sur le poids total du produit. Ajoutez l'anneau Möbius à votre article sans frais supplémentaire. N'oubliez pas de préciser « Imprimer l'anneau Möbius » dans votre commande. (L'anneau Möbius est imprimé par défaut dans le coin supérieur gauche)

ES > El porcentaje está calculado basado en el peso total del producto. Añade el Möbius loop a tu arte final sin cargo adicional. Por favor asegúrate de especificar "imprimir el Möbius loop" en tu pedido. (La impresión del Möbius loop a mano izquierda en la esquina)

Writing modes:

Mode écriture / Modos de escritura / Schreibmodi / Modalità di scrittura

Ballpen



M

Printing techniques:

Techniques d'impression / Técnicas de impresión / Drucktechniken / Tecniche di stampa



(SP) SCREEN PRINTING



(DG) DIGITAL

DE > Der Prozentsatz ist auf der Grundlage des Gesamtgewichts des Produkts berechnet. Zu Artwork Möbius-Loop hinzufügen, ohne Zusatzkosten. Vergessen Sie nicht "Möbius-Loop drucken" auf der Bestellung anzugeben (Möbius-Loop-Aufdruck standardmäßig auf der linken Ecke).

IT > La percentuale è calcolata in base al peso totale del prodotto. Aggiungi l'anello di Möbius al tuo disegno senza costi aggiuntivi. Assicurati di specificare "Stampare anello di Möbius" nel tuo ordine. (La stampa dell'anello di Möbius va in default nell'angolo sinistro)



Decoration:

Personalisation / Personalización / Dekoration / Decorazione

BIC® Wide Body™
1080
eColutions® 1E80

BIC® Wide Body™ Chrome
1079

- A/C SP:** max. 2 col.
- B/F SP:** max. 1 col.
- D DG:** full-colour (area for images)
- E DG:** full-colour (area for text)

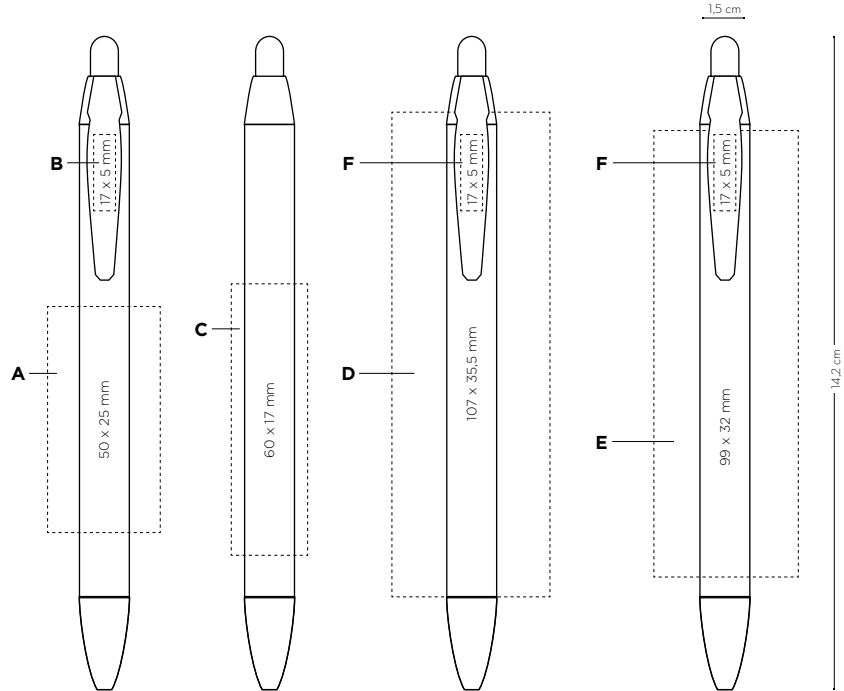

BIC® WRITING INSTRUMENTS
BALLPENS

	Price (€)						
BIC® Wide Body™	250-499	500-999	1000-2499	2500-4999	5000-9999	10000-24999	25000-49999
1080							
SP	1,04	0,95	0,89	0,83	0,76	①	①
DG	-	1,32	1,23	1,15	1,08	①	①
eColutions® 1E80							
SP	1,16	1,04	0,98	0,91	0,86	①	①
DG	-	1,41	1,32	1,23	1,18	①	①
1079							
SP	1,98	1,80	1,68	1,59	1,45	①	①
DG	-	2,17	2,02	1,91	1,77	①	①

ADDITIONAL IMPRINT CHARGE PER COLOUR & POSITION frais d'impression supplémentaires par couleur et position / cargo por impresión adicional por color y posición / zusätzliche druckkosten pro farbe & position / costo marchio aggiuntivo per colore e posizione

SP	0,16	0,13	0,13	0,13	0,12	①	①
-----------	------	------	------	------	------	---	---

Prices include one imprint in one position according to specified technique. Les prix incluent une impression sur un emplacement avec la technique spécifiée / Los precios incluyen una impresión en una posición acorde con la técnica especificada / In den Preisen inbegriffen ist ein Aufdruck auf einer Position gemäß angegebener Technik / I prezzi includono una stampa in una posizione a seconda della tecnica specificata.

① Price under request. Prix sur demande. Precio bajo consulta. Preis auf Anfrage. Prezzi su richiesta.

External packaging:

Emballage externe / Envasado exterior / Außenverpackung / Imballaggio esterno



BIC® Wide Body™ mini Digital
1893

BIC® Wide Body™ mini Chrome Digital
1896

A DG: full-colour (area for images)

B DG: full-colour (area for text)

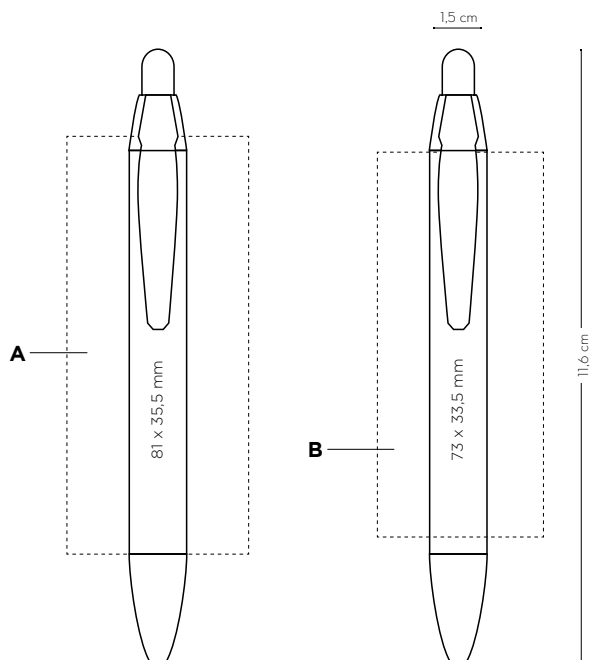

	Price (€)					
BIC® Wide Body™ mini Digital	500-499	1000-2499	2500-4999	5000-9999	10000-24999	25000-49999
1893						
DG	1,17	1,09	1,02	0,96	①	①
1896						
DG	2,02	1,88	1,78	1,65	①	①

Prices include digital imprint on barrel. Les prix incluent l'impression numérique sur le corps. El precio incluye impresión digital en el cuerpo. Preise beinhalten Digitaldruck auf dem Schaft. I prezzi comprendono la stampa digitale sul fusto.

① Price under request. Prix sur demande. Precio bajo consulta. Preis auf Anfrage. Prezzi su richiesta.

External packaging:

Emballage externe / Envasado exterior / Außenverpackung / Imballaggio esterno



250 ± 1,9 Kg



MADE IN SPAIN



Comfortable design with soft rubberised grip.
A smooth writing experience thanks to the
BIC® Easy Glide system® ink.

FR > Design pratique avec grip
en caoutchouc doux. Expérience
d'écriture fluide grâce au BIC®
Easy Glide system®.

ES > Diseño cómodo con suave
grip de goma. Experiencia de
escritura fluida gracias al BIC®
Easy Glide system®.

DE > Komfortabel Design
mit weicher Gummigriffzone.
Geschmeidiges, weiches
Schreiberlebnis dank des BIC®
Easy Glide Systems®.

IT > Design pratico con
impugnatura in gomma morbida.
Esperienza di scrittura fluida
grazie al BIC® Easy Glide system®.







OPAQUE - 1053

CLEAR - 1053



Iconic BIC® Boy is embossed

BIC® WRITING INSTRUMENTS

BALLPENS



07 02 01/03 01/05 01/07

Colour ink
Encre de couleur
Color de la tinta
Schreibfarbe
Colore inchiostro



01/02



51/07 51/02

soft grip,
easy to handle

FR > Grip doux, bonne prise en main

ES > Grip suave, fácil manejo

DE > Weicher Griff, einfach in der Handhabung

IT > Morbida impugnatura, molto maneggevole



MOA 250v.

Standard colours combination

Combinaison de couleurs standards / Combinación de colores estandar / Standardfarbcombination / Combinazione colori standard

Decoration:

Personnalisation / Personalización / Dekoration / Decorazione

BIC® Atlantis®

1053

A PD: max. 1 col.

B/C SP: max. 2 col.

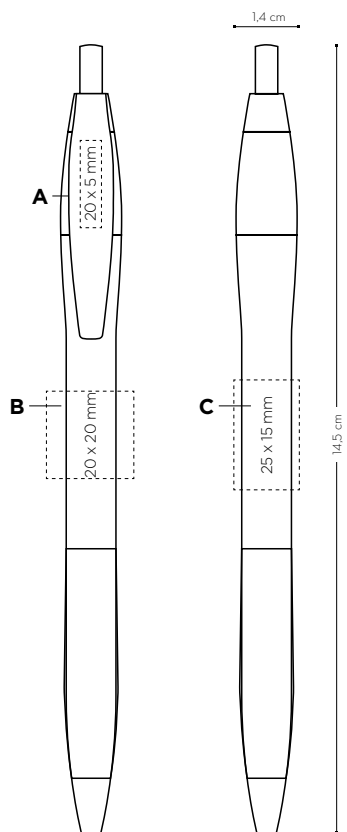

Price (€)

BIC® Atlantis®	250-499	500-999	1000-2499	2500-4999	5000-9999	10000-24999	25000-49999
1053							
SP/PD	1,38	1,25	1,16	1,08	1,02	①	①

ADDITIONAL IMPRINT CHARGE PER COLOUR & POSITION frais d'impression supplémentaires par couleur et position / cargo por impresión adicional por color y posición / zusätzliche druckkosten pro farbe & position / costo marchio aggiuntivo per colore e posizione

SP/PD	0,16	0,13	0,13	0,13	0,12	①	①
--------------	------	------	------	------	------	---	---

Prices include 1 colour screenprint in one position. Les prix incluent la sérigraphie 1 couleur sur un emplacement. En precio incluye un color en serigrafía en una posición. In den Preisen inbegriffen ist 1 Siebdruck-Farbaufdruck auf 1 Position. I prezzi includono 1 colore a serigrafia in una posizione.

① Price under request. Prix sur demande. Precio bajo consulta. Preis auf Anfrage. Prezzi su richiesta.

Writing modes:

Mode écriture / Modos de escritura / Schreibmodi / Modalità di scrittura

Ballpen



M

Printing techniques:

Techniques d'impression / Técnicas de impresión / Drucktechniken / Tecniche di stampa



(SP) SCREEN PRINTING



(PD) PAD PRINTING

External packaging:

Emballage externe / Envasado exterior / Außenverpackung / Imballaggio esterno



250 ± 2,3 Kg



MADE IN FRANCE



A versatile design that can match any style, from classic to modern, that adds environmental awareness to your message.

FR > Un design multifonction qui s'adapte à tous les styles, du classique au moderne, et qui apporte une dimension de responsabilité environnementale à votre message.

ES > Un diseño versátil que puede adaptarse a cualquier estilo, desde el clásico al moderno, y que añade conciencia ambiental a tu mensaje.

DE > Vielseitiges Design, das jede Stilrichtung verkörpert - von der Klassik bis hin zur Moderne. Umweltbewusstsein ist jetzt Teil Ihrer Botschaft.

IT > Un design versatile che può adattarsi a qualunque stile, da quello classico a quello moderno, con l'aggiunta di una coscienza ambientale al tuo messaggio.







Iconic BIC[®] Boy
is embossed



BIC[®] clic **ecolutions**[®]
OPAQUE - 1093

BIC[®] clic **ecolutions**[®]
CLEAR - 1093



01/35 12/35 03/35



5C/35



59/35 04/35 07/35 02/35



95/35 93/35



88/35



Colour ink
Encre de couleur
Color de la tinta
Schreibfarbe
Colore inchiostro

BIC[®] WRITING INSTRUMENTS

BALLPENS

MOQ 250v.

Decoration:

Personalisation / Personalización /
Dekoration / Decorazione

BIC® Clic eColutions®
eColutions® 1093

BIC® Clic Gold eColutions®
eColutions® 1091

A SP: max. 2 col.

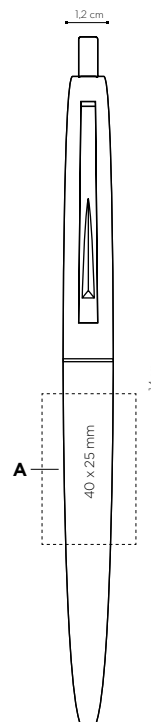

BIC® Clic Gold eColutions®
OPAQUE - 1091

CLEAR - 1091



01/26

07/26

02/26

86/26



Price (€)

BIC® Clic eColutions®	250-499	500-999	1000-2499	2500-4999	5000-9999	10000-24999	25000-49999
BIC® Clic Gold eColutions®							
eColutions® 1093/1091							
SP	1,48	1,33	1,24	1,16	1,09	①	①

ADDITIONAL IMPRINT CHARGE PER COLOUR & POSITION frais d'impression supplémentaires par couleur et position / cargo por impresión adicional por color y posición / zusätzliche druckkosten pro farbe & position / costo marchio aggiuntivo per colore e posizione

SP	0,16	0,13	0,13	0,13	0,12	①	①
-----------	------	------	------	------	------	---	---

Prices include 1 colour screenprint in one position. Les prix incluent la sérigraphie 1 couleur sur un emplacement. En precio incluye un color en serigrafía en una posición. In den Preisen inbegriffen ist 1 Siebdruck-Farbaufdruck auf 1 Position. I prezzi includono 1 colore a serigrafia in una posizione.

① Price under request. Prix sur demande. Precio bajo consulta. Preis auf Anfrage. Prezzi su richiesta.

MIX & MATCH SERVICE!

1093 / *1092 Clear
MOQ: 5.000 units
Please ask to your Customer Service for the available colours and all the information of this service.

MIX & MATCH SERVICE!

1093 / *1092 Clear
MOQ: 5.000 units
Please ask to your Customer Service for the available colours and all the information of this service.

MIX & MATCH SERVICE!

1093 / *1092 Clear
MOQ: 5.000 units
Please ask to your Customer Service for the available colours and all the information of this service.

MIX & MATCH SERVICE!

1093 / *1092 Clear
MOQ: 5.000 units
Please ask to your Customer Service for the available colours and all the information of this service.

MIX & MATCH SERVICE!

1093 / *1092 Clear
MOQ: 5.000 units
Please ask to your Customer Service for the available colours and all the information of this service.

Writing modes:

Mode écriture / Modos de escritura /
Schreibmodi / Modalità di scrittura

Ballpen



M

until stock lasts

Printing techniques:

Techniques d'impression / Técnicas de impresión /
Drucktechniken / Tecniche di stampa



(SP) SCREEN
PRINTING

External packaging:

Emballage externe / Envasado exterior /
Außenverpackung / Imballaggio esterno



250 ± 2,3 Kg

4 Colours

Simple, inventive, reliable. Four different ink colours in one: blue, black, red, green. An icon that's always in fashion!



FR > Simple, fiable, ingénieux.
Quatre couleurs d'encre différentes
sur un seul stylobille: bleu, noir,
rouge, vert. Un stylo emblématique
toujours à la mode !

DE > Einfach, einfallsreich, zuverlässig.
Vier verschiedene Tintenfarben in
einem Kugelschreiber: Blau, Schwarz,
Rot und Grün! Eine Schreibikone, die
immer in Mode bleibt.

ES > Simple, ingenioso, fiable.
Cuatro colores de tinta diferentes
en un sólo bolígrafo: azul, negro,
rojo, verde. ¡Un icono que siempre
está de moda!

IT > Semplice, ingegnosa,
affidabile. Quattro diversi colori in
una sola penna: blu, nero, rosso e
verde. Un'icona intramontabile!

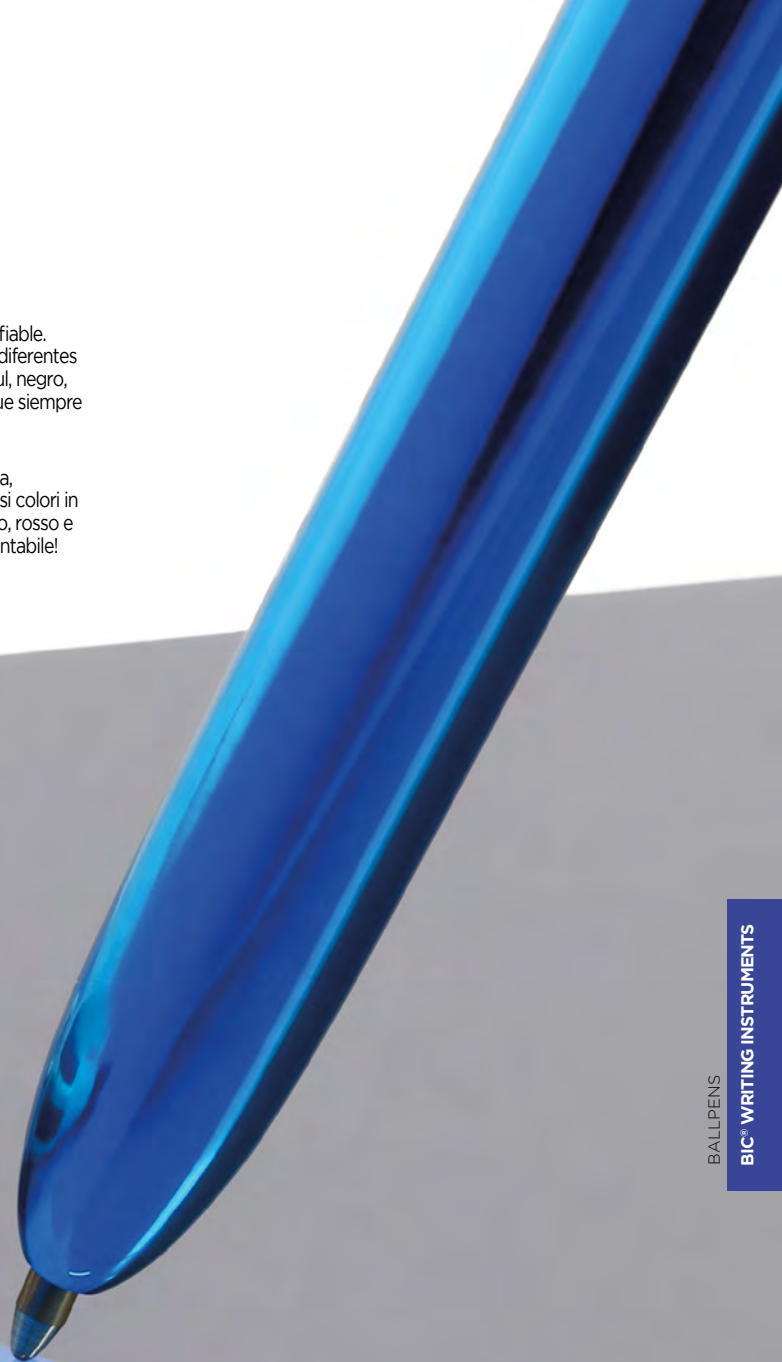



BIC® 4 Colours
OPAQUE - 1100
with lanyard - 1101



01/01

02/02

01/07

Colour ink
Encre de couleur
Color de la tinta
Schreibfarbe
Colore inchiostro



Digital Printing!

BIC® 4 Colours Digital
OPAQUE - 1100
with lanyard - 1101



01/01

01/01

Only available in white barrel
Disponible en corps blanc
Solo disponible en cuerpo blanco
Mit weißem Schaft erhältlich
Disponibile solo in fusto bianco



*48h not available in Digital finishes
*48h non disponible en impression numérique / *48h non disponibile en acabados digitales / *48h bei digitalen Ausführungen nicht erhältlich / *48h non disponibile in finiture digitali
Available without lanyard
Available without lanyard / Available without lanyard / Available without lanyard / Available without lanyard

** Source: GFK Panel - Western Europe 9 - MAT June 2018 - Sales in Value & Volume

MOQ 2500.

Decoration:

Personnalisation / Personalización / Dekoration / Decorazione

BIC® 4 colours

1100

A SP: max. 4 col.

B DG: full-colour
(available in white barrel)

C BP: full-colour

BP Texture: full-colour

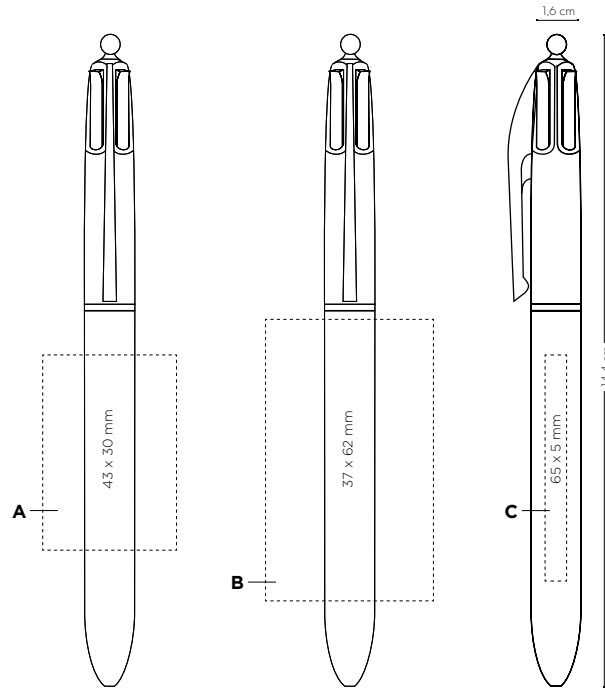

Price (€)

BIC® 4 colours	100-249	250-499	500-999	1000-2499	2500-4999	5000-9999	10000-24999	25000-49999
1100								
SP	-	2,88	2,61	2,42	2,26	2,13	1,98	1,83
DG	-	3,94	3,57	3,31	3,08	2,91	2,70	2,50
BP	3,82	3,11	2,82	2,62	2,45	2,31	2,14	1,98
1101 (lanyard)								
SP	-	3,29	2,98	2,76	2,59	2,44	2,29	2,13
DG	-	4,35	3,94	3,65	3,41	3,22	3,01	2,80
BP	4,28	3,52	3,19	2,96	2,78	2,62	2,45	2,28

ADDITIONAL IMPRINT CHARGE PER COLOUR & POSITION frais d'impression supplémentaires par couleur et position / cargo por impresión adicional por color y posición / zusätzliche druckkosten pro farbe & position / costo marchio aggiuntivo per colore e posizione

SP	-	0,16	0,13	0,13	0,13	0,12	0,11	0,11
BP	0,25	0,23	0,21	0,20	0,19	0,18	0,16	0,15
BP Texture	0,19	0,17	0,15	0,14	0,14	0,13	0,12	0,12

Prices include one imprint in one position according to specified technique. Les prix incluent une impression sur un emplacement avec la technique spécifiée / Los precios incluyen una impresión en una posición acorde con la técnica especificada / In den Preisen inbegriffen ist ein Aufdruck auf einer Position gemäß angegebener Technik / I prezzi includono una stampa in una posizione a seconda della tecnica specificata.

Writing modes:

Mode écriture / Modos de escritura / Schreibmodi / Modalità di scrittura

Ballpen



M

Printing techniques:

Techniques d'impression / Técnicas de impresión / Drucktechniken / Tecniche di stampa



(SP) SCREEN PRINTING



(DG) DIGITAL



(BP) britePix™



External packaging:

Emballage externe / Envasado exterior / Außenverpackung / Imballaggio esterno



250 ± 3,2 Kg

Check out the video

Regardez la video / Mira el video / Produktvideo / Guarda il video



MADE IN FRANCE





BIC® 4 Colours Mini
OPAQUE - 1103
with lanyard - 1104

BIC® WRITING INSTRUMENTS

BALLPENS



BIC® logo is embossed

MOQ 2500.

Decoration:

Personnalisation / Personalización / Dekoration / Decorazione

BIC® 4 Colours Mini
1103

D SP: max. 4 col.

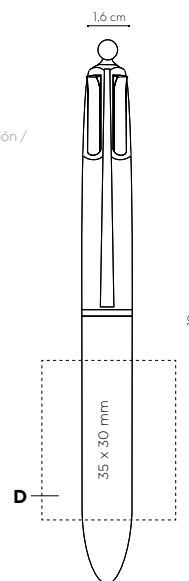

Price (€)

BIC® 4 Colours Mini	250-499	500-999	1000-2499	2500-4999	5000-9999	10000-24999	25000-49999
1103							
SP	3,07	2,78	2,58	2,41	2,27	2,18	2,10
1104 (lanyard)							
SP	3,48	3,15	2,92	2,74	2,58	2,49	2,40

ADDITIONAL IMPRINT CHARGE PER COLOUR & POSITION frais d'impression supplémentaires par couleur et position / cargo por impresión adicional por color y posición / zusätzliche druckkosten pro farbe & position / costo marchio aggiuntivo per colore e posizione

SP 0,16 0,13 0,13 0,13 0,12 0,11 0,11

Prices include 1 colour screenprint in one position. Les prix incluent la sérigraphie 1 couleur sur un emplacement. En precio incluye un color en serigrafía en una posición. In den Preisen inbegriffen ist 1 Siebdruck-Farbaufdruck auf 1 Position. I prezzi includono 1 colore a serigrafia in una posizione.

Writing modes:

Mode écriture / Modos de escritura / Schreibmodi / Modalità di scrittura

Ballpen



M

Printing techniques:

Techniques d'impression / Técnicas de impresión / Drucktechniken / Tecniche di stampa



(SP) SCREEN PRINTING

External packaging:

Emballage externe / Envasado exterior / Außenverpackung / Imballaggio esterno



250 ± 2,7 Kg



*48h not available in Digital finishes / 48h not available in Digital finishes / 48h not available in Digital finishes / 48h not available in Digital finishes

Available without lanyard

Available without lanyard / Available without lanyard / Available without lanyard / Available without lanyard



BIC® 4 Colours Sun
OPAQUE - 1097
with lanyard - 1098

2 new
flashy colours:
orange & yellow



01/12

01/12

Colour ink
Encre de couleur
Color de la tinta
Schreibfarbe
Colore inchiostro



FR > 2 nouvelles couleurs flashy :
orange et jaune

ES > 2 nuevos colores llamativos:
naranja y amarillo

DE > 2 neue leuchtende Farben:
orange & gelb

IT > 2 nuovi vistosi colori:
arancione e giallo

MOQ 250v.

Decoration:

Personalisation / Personalización /
Dekoration / Decorazione

BIC® 4 Colours Sun
1097

- A SP:** max. 4 col.
(available in white barrel)
- B BP:** full-colour
- BP Texture:** full-colour

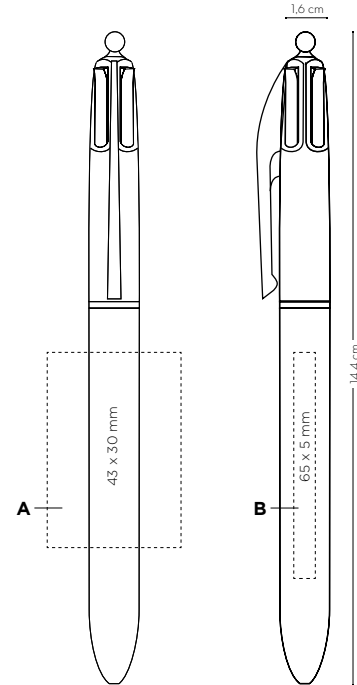

Price (€)

BIC® 4 Colours Sun	100-249	250-499	500-999	1000-2499	2500-4999	5000-9999	10000-24999	25000-49999
1097								
SP	-	2,88	2,61	2,42	2,26	2,13	1,98	1,83
BP	3,82	3,11	2,82	2,62	2,45	2,31	2,14	1,98
1098 (lanyard)								
SP	-	3,29	2,98	2,76	2,59	2,44	2,29	2,13
BP	4,28	3,52	3,19	2,96	2,78	2,62	2,45	2,28

ADDITIONAL IMPRINT CHARGE PER COLOUR & POSITION frais d'impression supplémentaires par couleur et position / cargo por impresión adicional por color y posición / zusätzliche druckkosten pro farbe & position / costo marchio aggiuntivo per colore e posizione

SP	-	0,16	0,13	0,13	0,13	0,12	0,11	0,11
BP	0,25	0,23	0,21	0,20	0,19	0,18	0,16	0,15
BP Texture	0,19	0,17	0,15	0,14	0,14	0,13	0,12	0,12

Prices include one imprint in one position according to specified technique. Les prix incluent une impression sur un emplacement avec la technique spécifiée / Los precios incluyen una impresión en una posición acorde con la técnica especificada / In den Preisen inbegriffen ist ein Aufdruck auf einer Position gemäÙ angegebener Technik / I prezzi includono una stampa in una posizione a seconda della tecnica specificata.

Writing modes:

Mode écriture / Modos de escritura /
Schreibmodi / Modalità di scrittura

Printing techniques:

Techniques d'impression / Técnicas de impresión /
Drucktechniken / Tecniche di stampa

External packaging:

Emballage externe / Envasado exterior /
Außenverpackung / Imballaggio esterno

Ballpen



M



(SP) SCREEN
PRINTING



(BP) britePix™



250 ± 3,2 Kg



MADE IN
FRANCE



*48h not available in Digital finishes
*48h non disponibile in impression numérique / *48h no disponibile
en acabados digitales / *48h bei digitalen Ausführungen nicht
erhältlich / *48h non disponibile in finiture digitali
Available without lanyard
Available without lanyard / Available without lanyard / Available
without lanyard / Available without lanyard





Fashion inks!

BIC® 4 Colours Fashion
OPAQUE - 1102
with lanyard - 1108

Digital Printing!

BIC® 4 Colours Digital
OPAQUE - 1102
with lanyard - 1108

BIC® WRITING INSTRUMENTS
BALLPENS



01/01

01/24

01/84

02/02



Colour ink
Encre de couleur
Color de la tinta
Schreibfarbe
Colore inchiostro



01/01

01/01



Only available in white barrel
Disponible en corps blanc
Solo disponible en cuerpo blanco
Mit weißem Schaft erhältlich
Disponibile solo in fusto bianco

FR > Encre fantaisie ES > Tintas a la moda! DE > Modische Tinten! IT > Colori fashion!

*48h not available in Digital finishes
*48h non disponible en impression numérique / *48h no disponibile en acabados digitales / *48h bei digitalen Ausführungen nicht erhältlich / *48h non disponibile in finiture digitali
Available without lanyard
Available without lanyard / Available without lanyard / Available without lanyard / Available without lanyard



MOQ 250v.

Decoration:

Personnalisation / Personalización / Dekoration / Decorazione

BIC® 4 Colours Fashion

1102

A SP: max. 4 col.

B DG: full-colours
(available in white barrel)

C BP: full-colour

BP Texture: full-colour

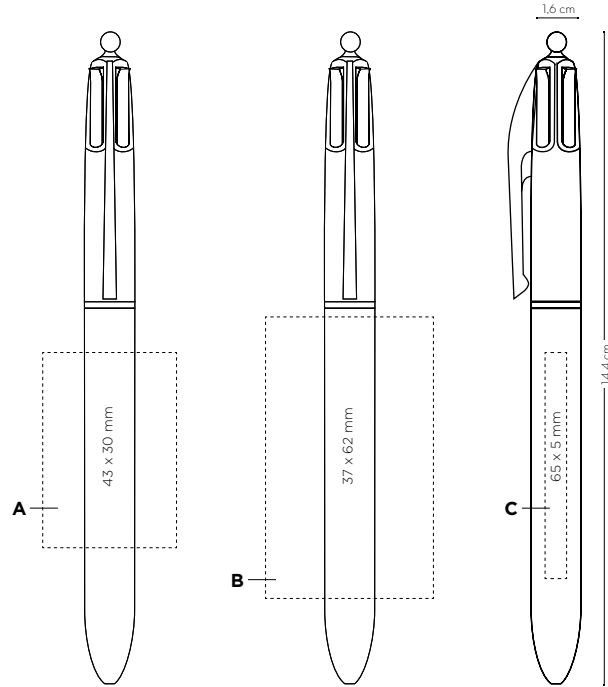

Price (€)

BIC® 4 Colours Fashion	100-249	250-499	500-999	1000-2499	2500-4999	5000-9999	10000-24999	25000-49999
1102								
SP	-	2,88	2,61	2,42	2,26	2,13	1,98	1,83
DG	-	3,94	3,57	3,31	3,08	2,91	2,70	2,50
BP	3,82	3,11	2,82	2,62	2,45	2,31	2,14	1,98
1108 (lanyard)								
SP	-	3,29	2,98	2,76	2,59	2,44	2,29	2,13
DG	-	4,35	3,94	3,65	3,41	3,22	3,01	2,80
BP	4,28	3,52	3,19	2,96	2,78	2,62	2,45	2,28

ADDITIONAL IMPRINT CHARGE PER COLOUR & POSITION frais d'impression supplémentaires par couleur et position / cargo por impresión adicional por color y posición / zusätzliche druckkosten pro farbe & position / costo marchio aggiuntivo per colore e posizione

SP	-	0,16	0,13	0,13	0,13	0,12	0,11	0,11
BP	0,25	0,23	0,21	0,20	0,19	0,18	0,16	0,15
BP Texture	0,19	0,17	0,15	0,14	0,14	0,13	0,12	0,12

Prices include one imprint in one position according to specified technique. Les prix incluent une impression sur un emplacement avec la technique spécifiée / Los precios incluyen una impresión en una posición acorde con la técnica especificada / In den Preisen inbegriffen ist ein Aufdruck auf einer Position gemäß angegebener Technik / I prezzi includono una stampa in una posizione a seconda della tecnica specificata.

Writing modes:

Mode écriture / Modos de escritura / Schreibmodi / Modalità di scrittura

Ballpen



M

Printing techniques:

Techniques d'impression / Técnicas de impresión / Drucktechniken / Tecniche di stampa



(SP) SCREEN PRINTING



(DG) DIGITAL



(BP) britePix™



External packaging:

Emballage externe / Envasado exterior / Außenverpackung / Imballaggio esterno



250 ± 3,2 Kg



MADE IN FRANCE



BIC® 4 Colours
Shine



BIC® 4 Colours Shine
OPAQUE - 1106
with lanyard - 1107



super shiny barrels!

01/75

01/26

01/34

Colour ink
Encre de couleur
Color de la tinta
Schreibfarbe
Colore inchiostro



01/7G



FR > Corps super brillant !

ES > ¡Cuerpos super brillantes!

DE > Super glänzende Schäfte!

IT > Fusti super brillanti!



MOA 250v.

Decoration:

Personnalisation / Personalización / Dekoration / Decorazione

BIC® 4 Colours Shine

1106

A SP: max. 4 col.

B LE

C LE

D LE 360°

New!

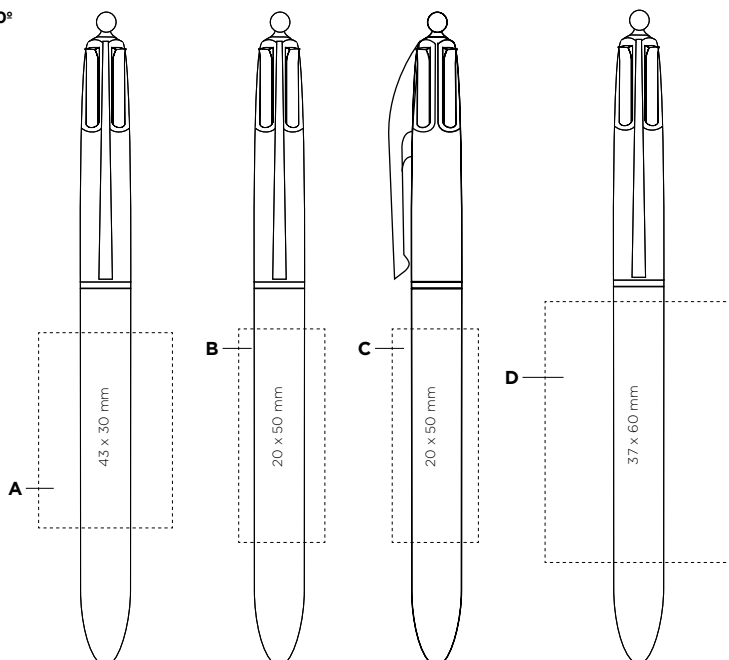

	Price (€)						
BIC® 4 Colours Shine	250-444	500-444	1000-2444	2500-4444	5000-4444	10000-24444	25000-44444
1106							
SP	3,30	2,97	2,76	2,58	2,42	2,25	2,09
LE	4,05	3,65	3,39	3,16	2,98	2,76	2,56
LE 360°	4,60	4,14	3,85	3,59	3,38	3,13	3,02
1107 (lanyard)							
SP	3,71	3,34	3,10	2,91	2,73	2,56	2,39
LE	4,46	4,02	3,73	3,49	3,29	3,07	2,86
LE 360°	5,01	4,51	4,19	3,92	3,69	3,44	3,32

ADDITIONAL IMPRINT CHARGE PER COLOUR & POSITION frais d'impression supplémentaires par couleur et position / cargo por impresión adicional por color y posición / zusätzliche druckkosten pro farbe & position / costo marchio aggiuntivo per colore e posizione

SP	0,16	0,13	0,13	0,13	0,12	0,11	0,11
----	------	------	------	------	------	------	------

Prices include one imprint in one position according to specified technique. Les prix incluent une impression sur un emplacement avec la technique spécifiée / Los precios incluyen una impresión en una posición acorde con la técnica especificada / In den Preisen inbegriffen ist ein Aufdruck auf einer Position gemäß angegebener Technik / I prezzi includono una stampa in una posizione a seconda della tecnica specificata.

① Price under request. Prix sur demande. Precio bajo consulta. Preis auf Anfrage. Prezzi su richiesta.

Writing modes:

Mode écriture / Modos de escritura / Schreibmodi / Modalità di scrittura

Ballpen



M

Printing techniques:

Techniques d'impression / Técnicas de impresión / Drucktechniken / Tecniche di stampa



(SP) SCREEN PRINTING



(LE) LASER

New!

External packaging:

Emballage externe / Envasado exterior / Außenverpackung / Imballaggio esterno



250 ± 3,2 Kg



MADE IN FRANCE



Fine



BIC® 4 Colours Fine
OPAQUE - 1109
with lanyard - 1111



BIC® WRITING INSTRUMENTS
BALLPENS

MOA 250v.

Decoration:
Personalisation / Personalización /
Dekoration / Decorazione

BIC® 4 Colours Fine
1109

A SP: max. 4 col.
B BP: full-colour
BP Texture: full-colour

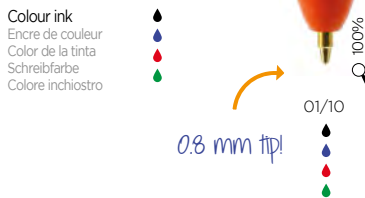
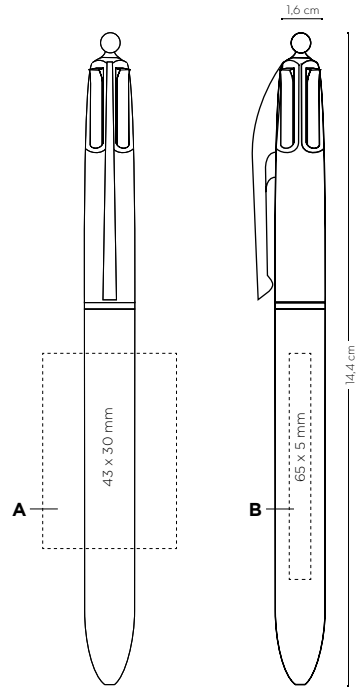

Price (€)

BIC® 4 Colours Fine	100-244	250-444	500-444	1000-2444	2500-4444	5000-4444	10000-24444	25000-44444
1109								
SP	-	2,88	2,61	2,42	2,26	2,13	1,98	1,83
BP	3,82	3,11	2,82	2,62	2,45	2,31	2,14	1,98

1111 (lanyard)								
SP	-	3,29	2,98	2,76	2,59	2,44	2,29	2,13
BP	4,28	3,52	3,19	2,96	2,78	2,62	2,45	2,28

ADDITIONAL IMPRINT CHARGE PER COLOUR & POSITION frais d'impression supplémentaires par couleur et position / cargo por impresión adicional por color y posición / zusätzliche druckkosten pro farbe & position / costo marchio aggiuntivo per colore e posizione

SP	-	0,16	0,13	0,13	0,13	0,12	0,11	0,11
BP	0,25	0,23	0,21	0,20	0,19	0,18	0,16	0,15
BP Texture	0,19	0,17	0,15	0,14	0,14	0,13	0,12	0,12

Prices include one imprint in one position according to specified technique. Les prix incluent une impression sur un emplacement avec la technique spécifiée / Los precios incluyen una impresión en una posición acorde con la técnica especificada / In den Preisen inbegriffen ist ein Aufdruck auf einer Position gemäß angegebener Technik / I prezzi includono una stampa in una posizione a seconda della tecnica specificata.

Writing modes:

Mode écriture / Modos de escritura / Schreibmodi / Modalità di scrittura

Ballpen



F

Printing techniques:

Techniques d'impression / Técnicas de impresión / Drucktechniken / Tecniche di stampa



(SP) SCREEN PRINTING



(BP) britePix™

External packaging:

Emballage externe / Envasado exterior / Außenverpackung / Imballaggio esterno



250 ± 3,2 Kg

*48h not available in Digital finishes
*48h non disponibile in impression numérique / *48h non disponibile en acabados digitales / *48h bei digitalen Ausführungen nicht erhältlich / *48h non disponibile in finiture digitali
Available without lanyard
Available without lanyard / Available without lanyard / Available without lanyard / Available without lanyard



MADE IN FRANCE





Fluo



BIC® 4 Colours Fluo
OPAQUE - 1114
with lanyard - 1116

FR > Encre jaune fluo ! ES > ¡Tinta amarilla fluo! DE > Neongelbe Tinte! IT > Inchiostro giallo fluo!



Fluo yellow ink!

MOQ 250U.

Decoration:

Personalisation / Personalización /
Dekoration / Decorazione

BIC® 4 Colours Fluo
1114

A SP: max. 4 col.

B BP: full-colour

BP Texture: full-colour

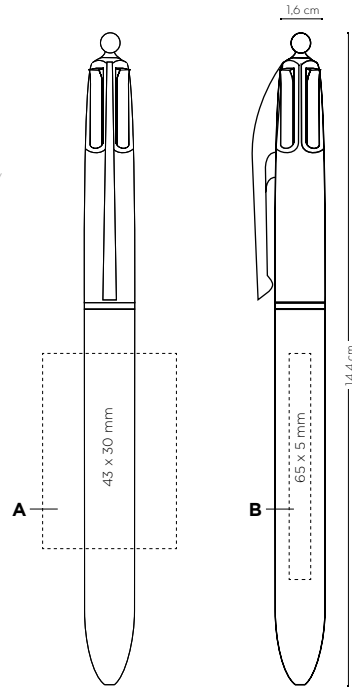

Price (€)

BIC® 4 Colours Fluo	100-249	250-499	500-999	1000-2499	2500-4999	5000-9999	10000-24999	25000-49999
1114								
SP	-	3,12	2,82	2,61	2,44	2,31	2,13	1,99
BP	4,11	3,35	3,03	2,81	2,63	2,49	2,29	2,14

1116 (lanyard)	100-249	250-499	500-999	1000-2499	2500-4999	5000-9999	10000-24999	25000-49999
SP	-	3,53	3,19	2,95	2,77	2,62	2,44	2,29
BP	4,57	3,76	3,40	3,15	2,96	2,80	2,60	2,44

ADDITIONAL IMPRINT CHARGE PER COLOUR & POSITION frais d'impression supplémentaires par couleur et position / cargo por impresión adicional por color y posición / zusätzliche druckkosten pro farbe & position / costo marchio aggiuntivo per colore e posizione

SP	-	0,16	0,13	0,13	0,13	0,12	0,11	0,11
BP	0,25	0,23	0,21	0,20	0,19	0,18	0,16	0,15
BP Texture	0,19	0,17	0,15	0,14	0,14	0,13	0,12	0,12

Prices include one imprint in one position according to specified technique. Les prix incluent une impression sur un emplacement avec la technique spécifiée / Los precios incluyen una impresión en una posición acorde con la técnica especificada / In den Preisen inbegriffen ist ein Aufdruck auf einer Position gemäß angegebener Technik / I prezzi includono una stampa in una posizione a seconda della tecnica specificata.

Writing modes:

Mode écriture / Modos de escritura /
Schreibmodi / Modalità di scrittura

Ballpen



B

*48h not available in Digital finishes
*48h non disponible en impression numérique / *48h no disponible en acabados digitales / *48h bei digitalen Ausführungen nicht erhältlich /
*48h non disponibile in finiture digitali

Available without lanyard

Available without lanyard / Available without lanyard / Available without lanyard / Available without lanyard

Printing techniques:

Techniques d'impression / Técnicas de impresión /
Drucktechniken / Tecniche di stampa



(SP) SCREEN
PRINTING



(BP) britePix™



External packaging:

Emballage externe / Envasado exterior /
Außenverpackung / Imballaggio esterno



250 ± 3,2 Kg



MADE IN
FRANCE



BIC® 4 Colours stylus



BIC® 4 Colours stylus
OPAQUE - 1112

soft pad for
touchscreen



FR > Cliquet en caoutchouc pour écran tactile!

ES > ¡Almohadilla suave para pantallas táctiles!

DE > Weiches Pad für Touchscreens!

IT > Punta morbida per touchscreen!

MOQ 250v.

Decoration:

Personnalisation / Personalización / Dekoration / Decorazione

BIC® 4 Colours stylus
1112

A SP: max. 1 col.

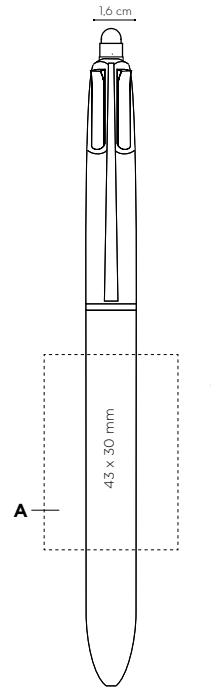

02/02

02/02

Colour ink
Encre de couleur
Color de la tinta
Schreibfarbe
Colore inchiostro



Price (€)

BIC® 4 Colours stylus	250-499	500-999	1000-2499	2500-4999	5000-9999	10000-24999	25000-49999
1112							
SP	3,43	3,10	2,87	2,69	2,53	2,40	2,27

Prices include 1 colour screenprint in one position. Les prix incluent la sérigraphie 1 couleur sur un emplacement. En precio incluye un color en serigrafía en una posición. In den Preisen inbegriffen ist 1 Siebdruck-Farbaufdruck auf 1 Position. I prezzi includono 1 colore a serigrafia in una posizione.

Writing modes:

Mode écriture / Modos de escritura / Schreibmodi / Modalità di scrittura

Ballpen



M

Printing techniques:

Techniques d'impression / Técnicas de impresión / Drucktechniken / Tecniche di stampa



(SP) SCREEN PRINTING

External packaging:

Emballage externe / Envasado exterior / Außenverpackung / Imballaggio esterno



250 ± 3,2 Kg



BIC® 4 Colours 3+1HB



BIC® 4 Colours 3+1HB
OPAQUE - 1099



01/06

Colour ink
Encre de couleur
Color de la tinta
Schreibfarbe
Colore inchiostro



01/06



New
printing area

MOQ 250v.

Decoration:

Personnalisation / Personalización /
Dekoration / Decorazione

BIC® 4 Colours 3+1HB

1099
A/B LE

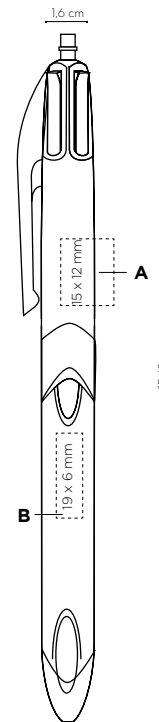

New!

Price (€)

BIC® 4 Colours 3+1HB 1099	250-499	500-999	1000-2499	2500-4999	5000-9999	10000-24999	25000-49999
LE	4,34	3,91	3,64	3,39	3,20	3,08	2,97

ADDITIONAL IMPRINT CHARGE PER IMPRINT & POSITION additional imprint charge per imprint & position / additional imprint charge per imprint & position / additional imprint charge per imprint & position / additional imprint charge per imprint & position

LE	1,21	1,09	0,96	0,96	0,96	0,96	0,96
----	------	------	------	------	------	------	------

Price includes 1 laser engraving in 1 position. Le prix comprend 1 gravure laser en 1 position. El precio incluye 1 grabado láser en una posición. Preise beinhalten eine Lasergravur an einer Position. Il prezzo comprende 1 incisione laser in 1 posizione.

Writing modes:

Mode écriture / Modos de escritura /
Schreibmodi / Modalità di scrittura

Balpen &
Mechanical pencil



M-MP Ø0,7mm

Printing techniques:

Techniques d'impression / Técnicas de impresión /
Drucktechniken / Tecniche di stampa



(LE) LASER

New!

External packaging:

Emballage externe / Envasado exterior /
Außenverpackung / Imballaggio esterno



250 ± 3,5 Kg

Check out the video

Regardez la vidéo / Mira el vídeo /
Produktvideo / Guarda il video





Metallic Pens

BIC® offers an exclusive selection of upscale writing instruments ideal for your corporate gift or recognition program.

FR > BIC® propose une sélection exclusive d'instruments d'écriture, idéale pour vos cadeaux d'affaire ou vos programmes de récompense.

DE > BIC® bietet eine exklusive Auswahl an gehobenen Schreibgeräten. Ideal als Werbegeschenk oder für Ihr Anerkennungsprogramm.

ES > BIC® ofrece una exclusiva selección de instrumentos de escritura de alta calidad ideal para tu programa de reconocimiento o regalo corporativo

IT > BIC® offre un'esclusiva selezione di pregiati strumenti di scrittura, ideali come regalo aziendale o per un programma di riconoscimento.





1840



Iconic BIC® Boy is embossed



50

Colour ink
Encre de couleur
Color de la tinta
Schreibfarbe
Colore inchiostro

02



MOA 50v.

Decoration:

Personalisation / Personalización / Dekoration / Decorazione

BIC® Attriant®
1840

A LE: right & left clip

B SP: max. 1 col.

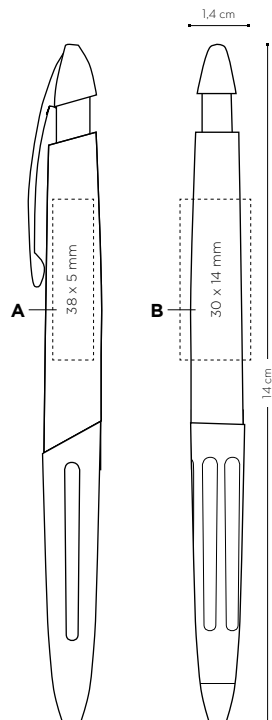

Price (€)

BIC® Attriant®	50-91	100-241	250-491	500-991	1000-2491	2500-4991	5000-9991
1840							
SP	7,29	6,79	6,29	5,88	5,51	①	①
LE	8,44	7,74	7,17	6,69	6,26	①	①

ADDITIONAL IMPRINT CHARGE PER COLOUR & POSITION frais d'impression supplémentaires par couleur et position / cargo por impresión adicional por color y posición / zusätzliche druckkosten pro farbe & position / costo marchio aggiuntivo per colore e posizione

LE	1,58	1,35	1,23	1,11	0,96	①	①
----	------	------	------	------	------	---	---

Prices include one imprint in one position according to specified technique. Les prix incluent une impression sur un emplacement avec la technique spécifiée / Los precios incluyen una impresión en una posición acorde con la técnica especificada / In den Preisen inbegriffen ist ein Aufdruck auf einer Position gemäß angegebener Technik / I prezzi includono una stampa in una posizione a seconda della tecnica specificata.

① Price under request. Prix sur demande. Precio bajo consulta. Preis auf Anfrage. Prezzi su richiesta.

Writing modes:

Mode écriture / Modos de escritura / Schreibmodi / Modalità di scrittura

Ballpen



M

Packaging:

emballage / envasado / verpackung / imballaggio



Standard Packaging:
Black velvet pouch
for 1 item

Printing techniques:

Techniques d'impression / Técnicas de impresión / Drucktechniken / Tecniche di stampa



(SP) SCREEN
PRINTING



(LE) LASER

External packaging:

Emballage externe / Envasado exterior / Außenverpackung / Imballaggio esterno



150 ± 4,65 Kg

*48h only available in LE *48h uniquement disponible en LE / *48h solo disponible en LE / *48h Nur für Lasergravur / *48 h disponibile solo in LE

BIC® Protrusion Grip



1836



Iconic BIC® Boy is embossed



47

Colour ink
Encre de couleur
Color de la tinta
Schreibfarbe
Colore inchiostro



02



MOQ 500.

Decoration:

Personnalisation / Personalización /
Dekoration / Decorazione

BIC® Protrusion Grip

1836

A LE: right & left clip

B SP: max. 1 col.

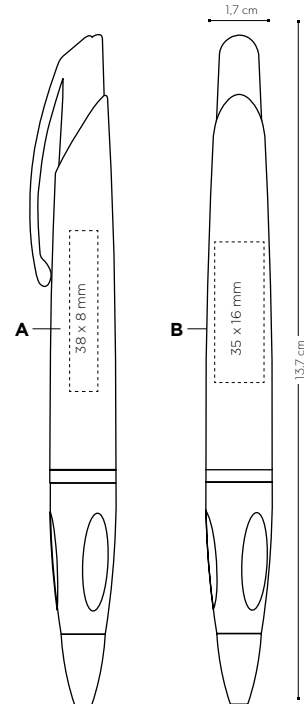

BIC® Protrusion Grip

1836

	50-99	100-249	250-499	500-999	1000-2499	2500-4999	5000-9999
SP	6,98	6,49	6,01	5,62	5,26	①	①
LE	8,13	7,44	6,89	6,43	6,01	①	①

ADDITIONAL IMPRINT CHARGE PER COLOUR & POSITION frais d'impression supplémentaires par couleur et position / cargo por impresión adicional por color y posición / zusätzliche druckkosten pro farbe & position / costo marchio aggiuntivo per colore e posizione

LE	1,58	1,35	1,23	1,11	0,96	①	①
-----------	------	------	------	------	------	---	---

Prices include one imprint in one position according to specified technique. Les prix incluent une impression sur un emplacement avec la technique spécifiée / Los precios incluyen una impresión en una posición acorde con la técnica especificada / In den Preisen inbegriffen ist ein Aufdruck auf einer Position gemäß angegebener Technik / I prezzi includono una stampa in una posizione a seconda della tecnica specificata.

① Price under request. Prix sur demande. Precio bajo consulta. Preis auf Anfrage. Prezzi su richiesta.

Writing modes:

Mode écriture / Modos de escritura /
Schreibmodi / Modalità di scrittura

Ballpen



M

*48h only available in LE / *48h uniquement disponible en LE / *48h solo disponible en LE / *48h Nur für Lasergravur / *48h disponibile solo in LE

Packaging:

embalaje / envasado /
verpackung / imballaggio



Standard Packaging:
Black velvet pouch
for 1 item

Printing techniques:

Techniques d'impression / Técnicas de impresión /
Drucktechniken / Tecniche di stampa



(SP) SCREEN
PRINTING



(LE) LASER

External packaging:

Emballage externe / Envasado exterior /
Außenverpackung / Imballaggio esterno



150 ± 4,65 Kg

Wide Body™ Metal



1285



02



07



100%

47

Iconic BIC® Boy
is embossed

Colour ink
Encre de couleur
Color de la tinta
Schreibfarbe
Colore inchiostro



BIC® WRITING INSTRUMENTS

METALLIC PENS

*48h only available in LE / *48h uniquement disponible en LE / *48h solo disponible en LE / *48h Nur für Lasergravur / *48 h disponibile solo in LE



MOQ 50v.

Decoration:

Personnalisation / Personalización / Dekoration / Decorazione

BIC® Wide Body Metal™

1285

A/B LE

C LE: right, left & rear clip

D/E/F SP: max. 1 col.

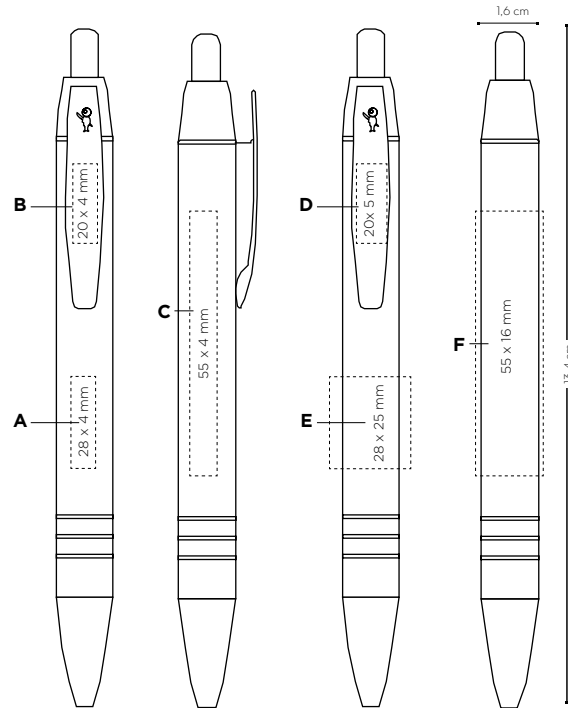

Price (€)

BIC® Wide Body Metal™	50-99	100-249	250-499	500-999	1000-2499	2500-4999	5000-9999
1285							
SP	5,43	5,05	4,67	4,37	4,07	①	①
LE	6,58	6,00	5,55	5,18	4,82	①	①

ADDITIONAL IMPRINT CHARGE PER COLOUR & POSITION frais d'impression supplémentaires par couleur et position / cargo por impresión adicional por color y posición / zusätzliche druckkosten pro farbe & position / costo marchio aggiuntivo per colore e posizione

SP	0,43	0,40	0,35	0,30	0,21	①	①
LE	1,58	1,35	1,23	1,11	0,96	①	①

Prices include one imprint in one position according to specified technique. Les prix incluent une impression sur un emplacement avec la technique spécifiée / Los precios incluyen una impresión en una posición acorde con la técnica especificada / In den Preisen inbegriffen ist ein Aufdruck auf einer Position gemäß angegebener Technik / I prezzi includono una stampa in una posizione a seconda della tecnica specificata.

① Price under request. Prix sur demande. Precio bajo consulta. Preis auf Anfrage. Prezzi su richiesta.

Writing modes:

Mode écriture / Modos de escritura / Schreibmodi / Modalità di scrittura

Ballpen



M

Packaging:

emballage / envasado / verpackung / imballaggio



Standard Packaging:
Black velvet pouch
for 1 item

Printing techniques:

Techniques d'impression / Técnicas de impresión / Drucktechniken / Tecniche di stampa



(SP) SCREEN
PRINTING



(LE) LASER

External packaging:

Emballage externe / Envasado exterior / Außenverpackung / Imballaggio esterno



150 ± 4 Kg

Tri-Tone Twist



BIC® WRITING INSTRUMENTS

METALLIC PENS

1943



08

Colour ink
Encre de couleur
Color de la tinta
Schreibfarbe
Colore inchiostro



25



100%



02

Iconic BIC® Boy
is embossed

*48h only available in LE / *48h uniquement disponible en LE / *48h solo disponible en LE / *48h Nur für Lasergravur / *48 h disponibile solo in LE



MOQ 500.

Decoration:

Personalisation / Personalización / Dekoration / Decorazione

BIC® TRI-TONE TWIST

1943

A LE: right, left & rear clip

B LE: right, left, rear
& clip centred **

C SP: max. 1 col.

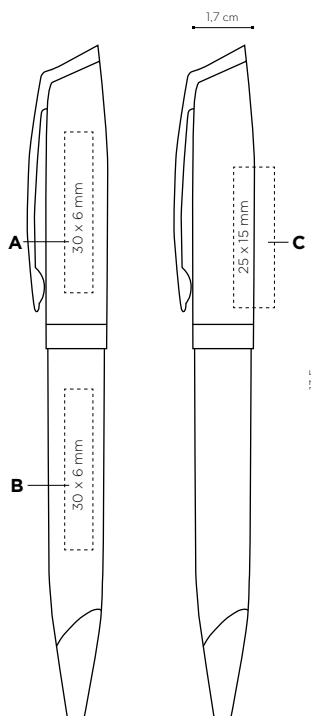

Price (€)

BIC® TRI-TONE TWIST	50-99	100-249	250-499	500-999	1000-2499	2500-4999	5000-9999
1943							
SP	8,06	7,50	6,95	6,51	6,10	①	①
LE	9,21	8,45	7,83	7,32	6,85	①	①

ADDITIONAL IMPRINT CHARGE PER COLOUR & POSITION frais d'impression supplémentaires par couleur et position / cargo por impresión adicional por color y posición / zusätzliche druckkosten pro farbe & position / costo marchio aggiuntivo per colore e posizione

LE	1,58	1,35	1,23	1,11	0,96	①	①
-----------	------	------	------	------	------	---	---

Prices include one imprint in one position according to specified technique. Les prix incluent une impression sur un emplacement avec la technique spécifiée / Los precios incluyen una impresión en una posición acorde con la técnica especificada / In den Preisen inbegriffen ist ein Aufdruck auf einer Position gemäß angegebener Technik / I prezzi includono una stampa in una posizione a seconda della tecnica specificata.

① Price under request. Prix sur demande. Precio bajo consulta. Preis auf Anfrage. Prezzi su richiesta.

Writing modes:

Mode écriture / Modos de escritura / Schreibmodi / Modalità di scrittura

Ballpen



M

LE not available on blue barrel
LE non disponibile sur corps bleu
LE no disponible en cuerpo azul
Lasergravur auf blauem Schaft ausgeschlossen
LE non disponibile su fusto blu

Packaging:

emballage / envasado / verpackung / imballaggio



Standard Packaging:
Black velvet pouch
for 1 item

Printing techniques:

Techniques d'impression / Técnicas de impresión / Drucktechniken / Tecniche di stampa



(SP) SCREEN
PRINTING



(LE) LASER

External packaging:

Emballage externe / Envasado exterior / Außenverpackung / Imballaggio esterno



150 ± 4,65 Kg

Gel-ocity® Illusion

BIC® Gel-ocity® Illusion® gel pen is an erasable gel stic pen.
Write, erase and rewrite repeatedly!



BIC® WRITING INSTRUMENTS

ROLLERS & GEL

FR > Le stylo BIC® Gel-ocity® Illusion® est un stylo à encre gel effaçable. Écrivez, effacez et réécrivez encore !

DE > BIC® Gel-ocity® Illusion® gel ist ein ausradierbarer Gel-Kugelschreiber. Schreiben, radieren, neu schreiben, immer wieder!

ES > El bolígrafo BIC® Gel-ocity Illusion® gel es un bolígrafo borrrable con tinta gel. ¡Escribe, borra y re-escribe repetidamente!

IT > La penna gel BIC® Gel-ocity Illusion® è uno strumento con inchiostro gel cancellabile. Scrivi, cancella e riscrivi quante volte vuoi!





ROLLERS & GEL
BIC® WRITING INSTRUMENTS



BIC Gel-ocity® Illusion

New!



OPAQUE - 1136



03

Colour ink
Encre de couleur
Color de la tinta
Schreibfarbe
Colore inchiostro



05



04



02



Erasable ink using
thermosensitive technology:
write, erase and rewrite
repeatedly

FR > L'encre effaçable utilise la technologie thermosensible : écrivez, effacez et réécrivez encore.

ES > Tinta borrable usando una tecnología termosensitiva: Escribe, borra y re-escribe repetidamente

DE > Ausradierbare Tinte dank temperaturempfindlicher Technologie: schreiben, radieren, neu schreiben, immer wieder.

IT > Inchiostro cancellabile grazie alla tecnologia termosensibile: scrivi, cancella e riscrivi quante volte vuoi



Available only in:
EU (including Norway, Switzerland and Turkey)
Disponibile unicamente in: UE (incluando la Norvegia, la Svizzera e la Turchia) / Solo disponibile in: EU (incluyendo Noruega, Suiza y Turquía) / Verfügbar nur in: EU (inklusive Norwegen, Schweiz und Türkei) / Disponibile solo in: UE (compresa Norvegia, Svizzera e Turchia)



MOQ 2500.

Decoration:

Personnalisation / Personalización / Dekoration / Decorazione

BIC® Gel-ocity® Illusion

1136

A SP: max. 1 col.

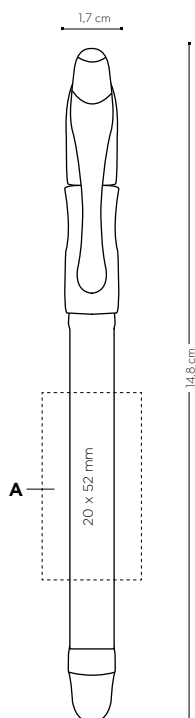

Price (€)

BIC® Gel-ocity® Illusion	250-499	500-999	1000-2499	2500-4999	5000-9999	10000-24999	25000-49999
1136							
SP	2,57	2,34	2,18	2,03	1,91	①	①

Prices include 1 colour screenprint in one position. Les prix incluent la sérigraphie 1 couleur sur un emplacement. En precio incluye un color en serigrafía en una posición. In den Preisen inbegriffen ist 1 Siebdruck-Farbaufdruck auf 1 Position. I prezzi includono 1 colore a serigrafia in una posizione.

① Price under request. Prix sur demande. Precio bajo consulta. Preis auf Anfrage. Prezzi su richiesta.

Writing modes:

Mode écriture / Modos de escritura / Schreibmodi / Modalità di scrittura

Gel erasable



GØ0,7mm

Printing techniques:

Techniques d'impression / Técnicas de impresión / Drucktechniken / Tecniche di stampa



(SP) SCREEN PRINTING

External packaging:

Emballage externe / Envasado exterior / Außenverpackung / Imballaggio esterno



500 ± 5,87 Kg

The logo features the BIC brand name in its signature yellow and black font, followed by 'Atlantis® Gel' in a blue, handwritten-style script. A small BIC character is positioned to the left of the brand name.

BIC® Atlantis® Gel

So fluid that it writes as quickly as you think. Feel the comfortable writing with the BIC® Atlantis® Gel, dressed in a modern look with metal clip and chrome painted trim.

BIC® WRITING INSTRUMENTS

ROLLERS & GEL

FR > La famille de produits Atlantis® accueille une version encre gel ultra-douce à l'aspect moderne, dotée d'un clip métallique et d'attributs chromés.

DE > So fließend das er schneller schreibt als Sie denken. Fühlen Sie das komfortable Schreiben mit dem BIC® Atlantis® Gel, gekleidet im modernen Look mit Metallclip und chromfarbigen Verzierungen.

ES > Tan fluido que escribe más rápido de lo que piensas. Siente la cómoda escritura con el BIC® Atlantis Gel, de aspecto moderno con el clip metal y atributos pintados de color cromado.

IT > Così fluido che scrive più velocemente di quanto pensi. Goditi un'esperienza di scrittura confortevole con il BIC® Atlantis® Gel, dal look moderno con clip in metallo e finitura cromata.





1062



Iconic BIC® Boy is embossed

MOQ 250v.

Decoration:

Personnalisation / Personalización / Dekoration / Decorazione

BIC® Atlantis® Gel
1062

A PD: right, left
or rear clip max 1 col.

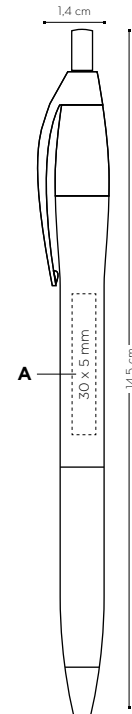

Colour ink
Encre de couleur
Color de la tinta
Schreibfarbe
Colore inchiostro

40



65

Price (€)

BIC® Atlantis® Gel	250-499	500-999	1000-2499	2500-4999	5000-9999	10000-24999	25000-49999
1062							
PD	1,54	1,39	1,29	1,20	1,13	①	①

ADDITIONAL IMPRINT CHARGE PER POSITION frais d'impression supplémentaires par position / cargo adicional por posición / zusätzliche druckkosten pro position / costo aggiuntivo di stampa per posizione

PD	0,16	0,13	0,13	0,13	0,12	①	①
----	------	------	------	------	------	---	---

Prices include 1 colour padprint in one position. Les prix incluent la tampographie monochrome sur un emplacement. Los precios incluyen una color en tampografía en una posición. In den Preisen inbegriffen ist ein Tampondruck-Aufdruck auf einer Position. I prezzi includono 1 colore con stampa a tampone in una posizione.

① Price under request. Prix sur demande. Precio bajo consulta. Preis auf Anfrage. Prezzi su richiesta.

Writing modes:

Mode écriture / Modos de escritura / Schreibmodi / Modalità di scrittura

Gel



GØ0,7mm

Printing techniques:

Techniques d'impression / Técnicas de impresión / Drucktechniken / Tecniche di stampa



(PD) PAD PRINTING

External packaging:

Emballage externe / Envasado exterior / Außenverpackung / Imballaggio esterno



250 ± 3 Kg

Grip Roller

Enjoy a smooth writing experience. Glide across the paper easily without smudging thanks to the quick-drying ink, ideal for both left and right-handed people.



FR > Profitez d'une expérience d'écriture fluide. Parfait pour les droitiers comme pour les gauchers, il glisse facilement sur le papier et ne fait pas de tâches grâce à son encre à séchage rapide.

ES > Disfruta de una experiencia de escritura suave. Se desliza fácilmente a través del papel y sin manchas gracias a la tinta de secado rápido, ideal tanto para las personas zurdas como diestras.

DE > Genießen Sie ein weiches Schreibgefühl. Gleiten Sie über das Papier ohne dass etwas verschmieren kann, dank der schnelltrocknenden Tinte - ideal für Links- und Rechtshänder.

IT > Goditi un'esperienza di scrittura morbidissima. Scorre facilmente sulla carta senza macchiare grazie all'inchiostro ad asciugatura immediata, ideale per mancini e destrorsi.



BIC® Grip Roller



Iconic BIC® Boy is embossed



BIC® Grip Roller
1187

BIC® WRITING INSTRUMENTS
ROLLERS & GEL



Colour ink
Encre de couleur
Color de la tinta
Schreibfarbe
Colore inchiostro



BIC® Grip Roller Gold
1195



02/26

MOQ 2500.

Decoration:

Personnalisation / Personalización / Dekoration / Decorazione

BIC® Grip Roller

1195

1187 (gold)

A/B SP: max. 3 col.

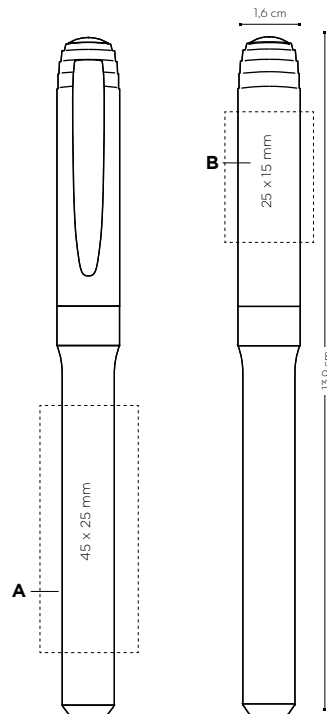

Price (€)

BIC® Grip Roller 1195/1187	250-499	500-999	1000-2499	2500-4999	5000-9999	10000-24999	25000-49999
SP	1,63	1,47	1,37	1,27	1,19	①	①

ADDITIONAL IMPRINT CHARGE PER COLOUR & POSITION frais d'impression supplémentaires par couleur et position / cargo por impresión adicional por color y posición / zusätzliche druckkosten pro farbe & position / costo marchio aggiuntivo per colore e posizione

SP	0,16	0,13	0,13	0,13	0,12	①	①
----	------	------	------	------	------	---	---

Prices include 1 colour padprint in one position. Les prix incluent la tampographie monochrome sur un emplacement. Los precios incluyen una color en tampografía en una posición. In den Preisen inbegriffen ist ein Tampondruck-Aufdruck auf einer Position. I prezzi includono 1 colore con stampa a tampone in una posizione.

① Price under request. Prix sur demande. Precio bajo consulta. Preis auf Anfrage. Prezzi su richiesta.

Writing modes:

Mode écriture / Modos de escritura / Schreibmodi / Modalità di scrittura

Roller



RØ0,7mm

Printing techniques:

Techniques d'impression / Técnicas de impresión / Drucktechniken / Tecniche di stampa



(SP) SCREEN PRINTING

External packaging:

Emballage externe / Envasado exterior / Außenverpackung / Imballaggio esterno



250 ± 3 Kg



Intensity® Gel Clic

Stylish ultra-smooth gel pen available in blue and black ink.
Automatic retracting mechanism to avoid stains on the pockets.

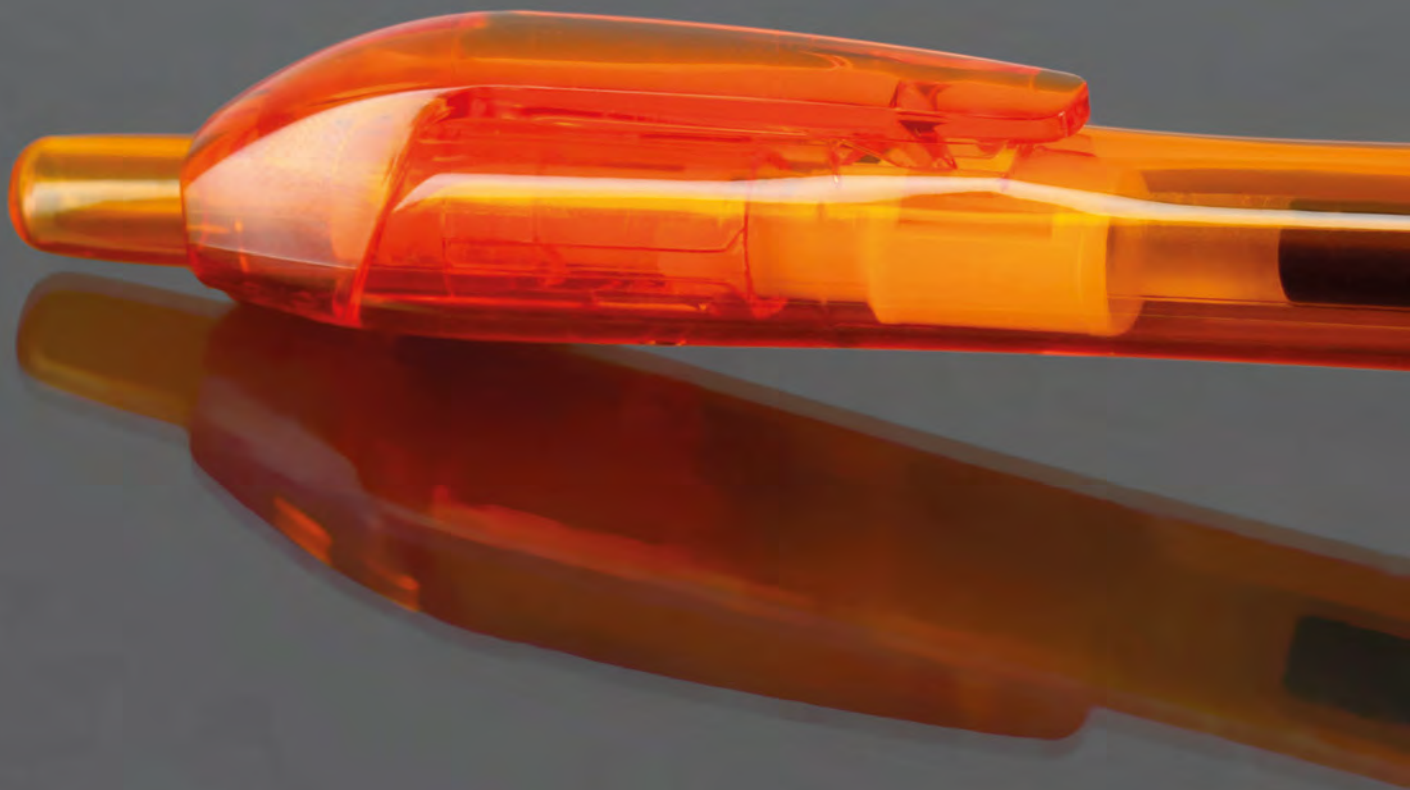

FR > Stylo-bille gel ultra doux, disponible avec une encre bleue ou noire. Mécanisme de rétraction automatique pour éviter les taches sur les poches.

DE > Stylishes, ultraweiches Gelschreibgerät mit blauer oder schwarzer Tinte. Automatische Einzugmechanik, die Verschmutzungen in der Tasche verhindert.

ES > Bolígrafo de gel ultra suave disponible en tinta azul y negro. Mecanismo automático retráctil para evitar manchas en los bolsillos.

IT > Penna gel ultra morbida disponibile in scrittura blu e nero. Meccanismo automatico per evitare macchie nelle tasche.



ROLLERS & GEL
BIC® WRITING INSTRUMENTS



BIC Intensity® Gel Clic



OPAQUE - 1196

CLEAR - 1196

BIC® WRITING INSTRUMENTS
ROLLERS & GEL

Iconic BIC® Boy is embossed





Colour ink
 Encre de couleur
 Color de la tinta
 Schreibfarbe
 Colore inchiostro

*until stock lasts
 Jusqu'à épuisement du stock / Hasta que se acabe el stock /
 Solange der Vorrat reicht / Fino a esaurimento scorte

MOQ 250v.

Decoration:

Personalisation / Personalización / Dekoration / Decorazione

BIC® Intensity® Gel Clic

1196

A SP: max. 2 col.

B SP: max. 4 col.

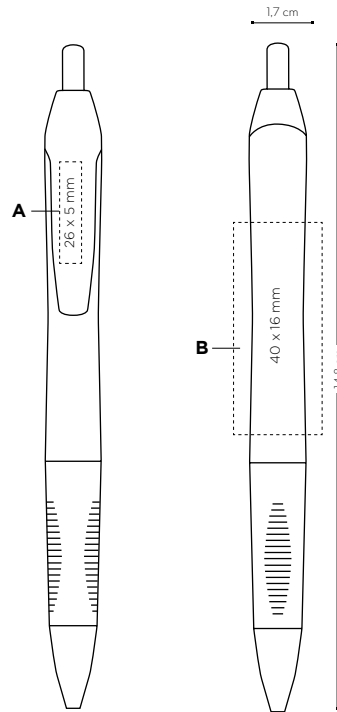

Price (€)

BIC® Intensity® Gel Clic	250-499	500-999	1000-2499	2500-4999	5000-9999	10000-24999	25000-49999
1196							
SP	2,64	2,40	2,22	2,07	1,95	①	①

ADDITIONAL IMPRINT CHARGE PER COLOUR & POSITION frais d'impression supplémentaires par couleur et position / cargo por impresión adicional por color y posición / zusätzliche druckkosten pro farbe & position / costo marchio aggiuntivo per colore e posizione

SP	0,16	0,13	0,13	0,13	0,12	①	①
-----------	------	------	------	------	------	---	---

Prices include 1 colour screenprint in one position. Les prix incluent la sérigraphie 1 couleur sur un emplacement. En precio incluye un color en serigrafía en una posición. In den Preisen inbegriffen ist 1 Siebdruck-Farbaufdruck auf 1 Position. I prezzi includono 1 colore a serigrafia in una posizione.

① Price under request. Prix sur demande. Precio bajo consulta. Preis auf Anfrage. Prezzi su richiesta.

Writing modes:

Mode écriture / Modos de escritura / Schreibmodi / Modalità di scrittura

Gel



GØ0,7mm

Printing techniques:

Techniques d'impression / Técnicas de impresión / Drucktechniken / Tecniche di stampa



(SP) SCREEN PRINTING

External packaging:

Emballage externe / Envasado exterior / Außenverpackung / Imballaggio esterno



250 ± 3,7 Kg

Roller Glide® PRO

Water based ink for smooth writing experience.
Cap off time more than 2 hours. Translucid
colour barrel for ink level visibility.

FR > Encre à base d'eau pour un plus grand
confort d'écriture. Le capuchon peut être retiré
pendant plus de 2 heures. Corps de couleur
translucide permettant de voir le niveau d'encre.

ES > Tinta a base de agua para una experiencia
de escritura suave. Se puede tener destapado
durante más de 2 horas. Cuerpo translúcido para
poder ver el nivel de tinta.

DE > Wasserbasierte Tinte für softes
Schreiberlebnis.
Über 2 Stunden Cap-off-Zeit. Transluzenter,
farbiger Schaft für sichtbaren Tintenstand.

IT > Inchiostro a base di acqua per un'esperienza
di scrittura scorrevole. Può restare più di 2 ore
senza cappuccio. Serbatoio colorato trasparente
per verificare il livello dell'inchiostro.





1197



MOA 250v.

Decoration:

Personnalisation / Personalización / Dekoration / Decorazione

BIC® Roller Glide PRO

1197

A SP: max 1 col.

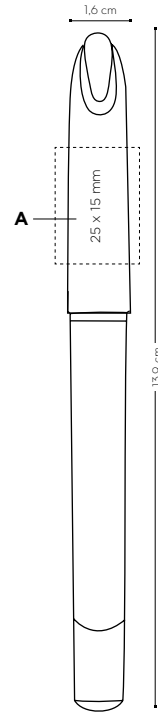

Price (€)

BIC® Roller Glide PRO	250-499	500-999	1000-2499	2500-4999	5000-9999	10000-24999	25000-49999
1197							
SP	1,85	1,68	1,56	1,47	1,38	①	①

Prices include 1 colour screenprint in one position. Les prix incluent la sérigraphie 1 couleur sur un emplacement. En precio incluye un color en serigrafía en una posición. In den Preisen inbegriffen ist 1 Siebdruck-Farbaufdruck auf 1 Position. I prezzi includono 1 colore a serigrafia in una posizione.

① Price under request. Prix sur demande. Precio bajo consulta. Preis auf Anfrage. Prezzi su richiesta.

Colour ink
Encre de couleur
Color de la tinta
Schreibfarbe
Colore inchiostro

01/04

01/02

Q 100%

Writing modes:

Mode écriture / Modos de escritura / Schreibmodi / Modalità di scrittura

Roller



RØ0,7mm

Printing techniques:

Techniques d'impression / Técnicas de impresión / Drucktechniken / Tecniche di stampa



(SP) SCREEN PRINTING

External packaging:

Emballage externe / Envasado exterior / Außenverpackung / Imballaggio esterno



400 ± 2,6 Kg

XS Finestyle

Super-smooth roller with Finestyle ink point. Exclusive britePix™ full-colour printing on the clip also available.

FR > Roller super doux avec pointe feutre fine. Désormais disponible aussi en version britePix™ toutes couleurs sur le clip.

ES > Roller súper fluido con punta Finestyle. Ahora también disponible con britePix™ en el clip.

DE > Extrem sanft gleitender Rollerball mit Finestyle-Spitze. Nun auch erhältlich mit britePix™ Vollfarbkonzept auf dem Clip.

IT > Roller a scrittura ultra-fluida con punta Finestyle. Adesso disponibile anche con concetto di stampa a colori britePix™ sulla clip.





BIC[®] XS Finestyle



OPAQUE - 1851



01/12

01/03

01/24

01/25

Colour ink
Encre de couleur
Color de la tinta
Schreibfarbe
Colore inchiostro



01/05



01/06

01/02



OPAQUE / CLEAR - 1851



01/89



*48h not available for britePix™ decoration *48h non disponibile en impression britePix™ / *48h no disponible para personalización britePix™ / *britePix™ Druck ausgeschlossen / *48 h non disponibile per personalizzazione britePix™



MOA 250v.

Decoration:

Personnalisation / Personalización / Dekoration / Decorazione

BIC® XS Finestyle

1851

A PD: max 2 col.

B SP: max 2 col.

C BP: full-colour

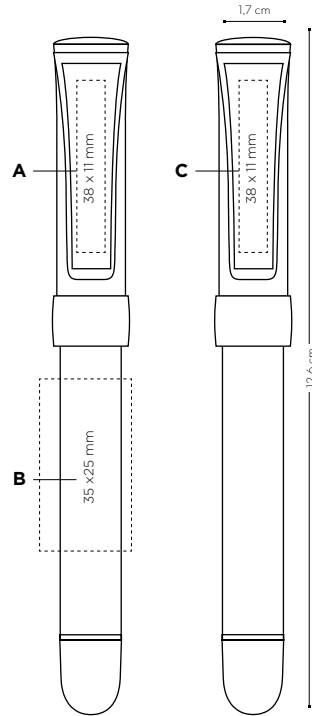

Price (€)

BIC® XS Finestyle	250-441	500-441	1000-2441	2500-4441	5000-4441	10000-24441	25000-44441
1851							
SP/PD	1,71	1,56	1,46	1,36	1,26	①	①
BP	1,94	1,77	1,66	1,55	1,44	①	①

ADDITIONAL IMPRINT CHARGE PER COLOUR & POSITION frais d'impression supplémentaires par couleur et position / cargo por impresión adicional por color y posición / zusätzliche druckkosten pro farbe & position / costo marchio aggiuntivo per colore e posizione

SP/PD	0,16	0,13	0,13	0,13	0,12	①	①
BP Texture	0,17	0,15	0,14	0,14	0,13	①	①

Prices include one imprint in one position according to specified technique. Les prix incluent une impression sur un emplacement avec la technique spécifiée / Los precios incluyen una impresión en una posición acorde con la técnica especificada / In den Preisen inbegriffen ist ein Aufdruck auf einer Position gemäß angegebener Technik / I prezzi includono una stampa in una posizione a seconda della tecnica specificata.

① Price under request. Prix sur demande. Precio bajo consulta. Preis auf Anfrage. Prezzi su richiesta.

Exact colour match:

Correspondance exacte des couleurs / Color exacto / Exakte Farbübereinstimmung / Esatta corrispondenza di colore

≥ 10.000 units

Writing modes:

Mode écriture / Modos de escritura / Schreibmodi / Modalità di scrittura



FSØ0,7mm

Printing techniques:

Techniques d'impression / Técnicas de impresión / Drucktechniken / Tecniche di stampa



(SP) SCREEN PRINTING



(PD) PAD PRINTING



(BP) britePix™



External packaging:

Emballage externe / Envasado exterior / Außenverpackung / Imballaggio esterno



250 ± 2,8 Kg



MADE IN SPAIN

 Brite Liner® Grip

Highlight your message with precision and control thanks to the textured rubberised grip.



BIC® WRITING INSTRUMENTS
HIGHLIGHTERS & MARKERS



FR > Donnez de l'impact à votre message par la précision et le contrôle, grâce au grip en caoutchouc.

DE > Markieren Sie Ihre Botschaft präzise und kontrolliert dank der strukturierten, gummierten Griffzone.

ES > Resalta tu mensaje con precisión y control gracias al grip de goma.

IT > Fai risaltare il tuo messaggio con precisione e controllo grazie all'impugnatura in gomma.



Brite Liner® Grip



New Colour!

New Colour!

New Colour!

New Colour!

1192



12



10



14



100%



24



59



85



83



3G



8D



BIC® WRITING INSTRUMENTS

HIGHLIGHTERS & MARKERS

Colour ink
Encre de couleur
Color de la tinta
Schreibfarbe
Colore inchiostro



MOQ 250v.

Decoration:

Personalisation / Personalización /
Dekoration / Decorazione

BIC® Brite Liner® Grip

1192

A/B SP: max. 3 col.

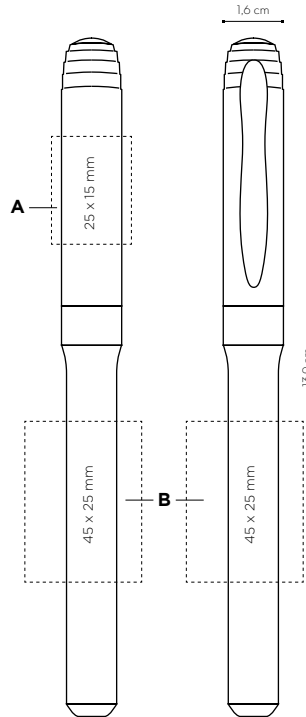

HIGHLIGHTERS & MARKERS
BIC® WRITING INSTRUMENTS

	Price (€)						
BIC® Brite Liner® Grip	250-499	500-999	1000-2499	2500-4999	5000-9999	10000-24999	25000-49999
1192							
SP	1,46	1,35	1,23	1,15	1,08	①	①

ADDITIONAL IMPRINT CHARGE PER COLOUR & POSITION frais d'impression supplémentaires par couleur et position / cargo por impresión adicional por color y posición / zusätzliche druckkosten pro farbe & position / costo marchio aggiuntivo per colore e posizione

SP	0,16	0,13	0,13	0,13	0,12	①	①
-----------	------	------	------	------	------	---	---

Prices include 1 colour screenprint in one position. Les prix incluent la sérigraphie 1 couleur sur un emplacement. En precio incluye un color en serigrafía en una posición. In den Preisen inbegriffen ist 1 Siebdruck-Farbaufdruck auf 1 Position. I prezzi includono 1 colore a serigrafia in una posizione.

① Price under request. Prix sur demande. Precio bajo consulta. Preis auf Anfrage. Prezzi su richiesta.

Writing modes:

Mode écriture / Modos de escritura /
Schreibmodi / Modalità di scrittura

Highlighter



HL

Printing techniques:

Techniques d'impression / Técnicas de impresión /
Drucktechniken / Tecniche di stampa



(SP) SCREEN
PRINTING

External packaging:

Emballage externe / Envasado exterior /
Außenverpackung / Imballaggio esterno



250 ± 2,8 Kg





BIC® markers offer you products specifically designed to write in highly visible way and mark on surfaces or material that other writing instruments cannot mark on. Make your ideas visible and express yourself whatever the surface with BIC® Markers.



FR > Les marqueurs BIC® vous proposent des produits spécifiquement conçus pour écrire avec une haute visibilité, et sur des surfaces ou des matériaux sur lesquels d'autres instruments d'écriture ne peuvent être utilisés. Donnez de la visibilité à vos idées et exprimez-vous sur n'importe quelle surface avec les marqueurs BIC®.

ES > BIC® te ofrece productos especialmente diseñados para escribir de una manera altamente visible y marcar superficies o materiales que otros instrumentos de escritura no pueden marcar. Haz tus ideas visibles y expresasate a ti mismo en cualquier superficie con los marcadores BIC®

DE > BIC®-Textmarker bieten Produkte, die speziell konzipiert wurden, um besonders sichtbar zu schreiben und auf Oberflächen oder Materialien zu markieren, wo anderes Schreibgerät passen muss. Machen Sie Ihre Ideen sichtbar, bringen Sie sie zum Ausdruck, egal auf welcher Fläche, mit BIC® Textmarkern.

IT > BIC® offre prodotti specificamente ideati per scrivere in modo particolarmente visibile e lasciare il segno su superfici o materiali su cui altri strumenti di scrittura non funzionano. Esprimiti e dai visibilità alle tue idee su qualsiasi tipo di superficie con i pennarelli BIC®.



BIC Velleda White Board Marker Fine



1651



01/03

01/04

01/02

01/05

Colour ink
Encre de couleur
Color de la tinta
Schreibfarbe
Colore inchiostro

MOA 500v.

Decoration:

Personalisation / Personalización /
Dekoration / Decorazione

BIC Velleda White Board
Marker Fine

1651

A SP: max. 1 col.

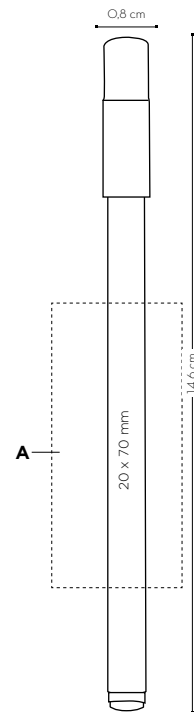

Price (€)

BIC Velleda White Board Marker Fine 1651	250-499	500-999	1000-2499	2500-4999	5000-9999	10000-24999	25000-49999
SP	-	0,54	0,49	0,46	0,43	0,40	0,37

Prices include 1 colour screenprint in one position. Les prix incluent la sérigraphie 1 couleur sur un emplacement. En precio incluye un color en serigrafía en una posición. In den Preisen inbegriffen ist 1 Siebdruck-Farbaufdruck auf 1 Position. I prezzi includono 1 colore a serigrafia in una posizione.

Writing modes:

Mode écriture / Modos de escritura /
Schreibmodi / Modalità di scrittura

Marker



MK

Printing techniques:

Techniques d'impression / Técnicas de impresión /
Drucktechniken / Tecniche di stampa



(SP) SCREEN
PRINTING

External packaging:

Emballage externe / Envasado exterior /
Außenverpackung / Imballaggio esterno



500 ± 3,2 Kg



MADE IN
FRANCE



BIC Velleda White Board Marker Grip



New Colour!
New Colour!
New Colour!

1213



Colour ink
Encre de couleur
Color de la tinta
Schreibfarbe
Colore inchiostro

01/03 01/05 01/04

01/02



MOQ 2500.

Decoration:

Personalisation / Personalización /
Dekoration / Decorazione

BIC Velleda White Board
Marker Grip 1213

A/B SP: max. 3 col.

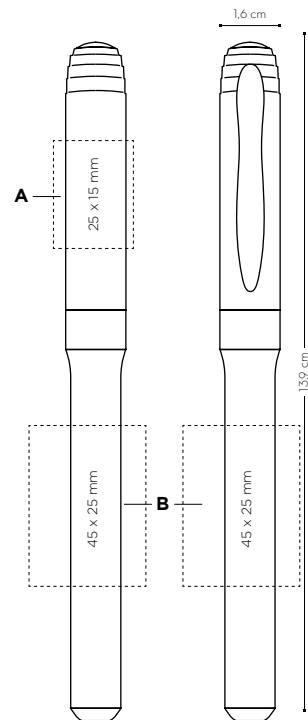

Price (€)

BIC Velleda White Board
Marker Grip
1213

250-499 500-999 1000-2499 2500-4999 5000-9999 10000-24999 25000-49999

SP	1,45	1,30	1,21	1,13	1,06	①	①
----	------	------	------	------	------	---	---

ADDITIONAL IMPRINT CHARGE PER COLOUR & POSITION frais d'impression supplémentaires par couleur et position / cargo por impresión adicional por color y posición / zusätzliche druckkosten pro farbe & position / costo marchio aggiuntivo per colore e posizione

SP	0,16	0,13	0,13	0,13	0,12	①	①
----	------	------	------	------	------	---	---

Prices include 1 colour screenprint in one position. Les prix incluent la sérigraphie 1 couleur sur un emplacement. En precio incluye un color en serigrafía en una posición. In den Preisen inbegriffen ist 1 Siebdruck-Farbaufdruck auf 1 Position. I prezzi includono 1 colore a serigrafia in una posizione.

① Price under request. Prix sur demande. Precio bajo consulta. Preis auf Anfrage. Prezzi su richiesta.

Writing modes:

Mode écriture / Modos de escritura /
Schreibmodi / Modalità di scrittura

White board marker



MK

Printing techniques:

Techniques d'impression / Técnicas de impresión /
Drucktechniken / Tecniche di stampa



(SP) SCREEN
PRINTING

External packaging:

Emballage externe / Envasado exterior /
Außenverpackung / Imballaggio esterno



250 ± 2,7 Kg

HIGHLIGHTERS & MARKERS
BIC® WRITING INSTRUMENTS

BIC® Mark-it Permanent Marker



New Colour!
New Colour!

1214



Colour ink
Encre de couleur
Color de la tinta
Schreibfarbe
Colore inchiostro

100%

MOA 250v.

Decoration:

Personnalisation / Personalización /
Dekoration / Decorazione

BIC® Mark-it Permanent
Marker

1214

A/B SP: max. 3 col.

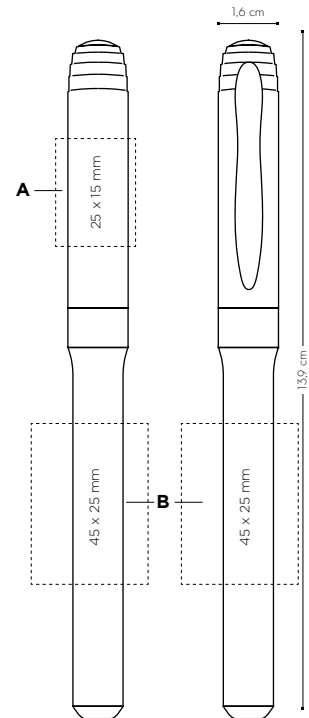

Price (€)

BIC® Mark-it
Permanent Marker

250-499 500-999 1000-2499 2500-4999 5000-9999 10000-24999 25000-49999

1214

SP	1,45	1,30	1,21	1,13	1,06	①	①
----	------	------	------	------	------	---	---

ADDITIONAL IMPRINT CHARGE PER COLOUR & POSITION frais d'impression supplémentaires par couleur et position / cargo por impresión adicional por color y posición / zusätzliche druckkosten pro farbe & position / costo marchio aggiuntivo per colore e posizione

SP	0,16	0,13	0,13	0,13	0,12	①	①
----	------	------	------	------	------	---	---

Prices include 1 colour screenprint in one position. Les prix incluent la sérigraphie 1 couleur sur un emplacement. En precio incluye un color en serigrafía en una posición. In den Preisen inbegriffen ist 1 Siebdruck-Farbaufdruck auf 1 Position. I prezzi includono 1 colore a serigrafia in una posizione.

① Price under request. Prix sur demande. Precio bajo consulta. Preis auf Anfrage. Prezzi su richiesta.

Writing modes:

Mode écriture / Modos de escritura /
Schreibmodi / Modalità di scrittura

Printing techniques:

Techniques d'impression / Técnicas de impresión /
Drucktechniken / Tecniche di stampa

External packaging:

Emballage externe / Envasado exterior /
Außenverpackung / Imballaggio esterno

Marker



MK



(SP) SCREEN
PRINTING



250 ± 2,8 Kg



BIC® Permanent Marker eCOlutions®



eCOlutions® Made with 51% recycled material.
The percentage is calculated based on the total weight of the product.
Add the Möbius loop to your artwork at no additional charge. Please be sure to specify "Print the Möbius loop" on your order. (Möbius loop imprint defaults to left-hand hand corner.)

FR > Le pourcentage est calculé sur le poids total du produit.
Ajoutez l'anneau Möbius à votre article sans frais supplémentaire. N'oubliez pas de préciser « Imprimer l'anneau Möbius » dans votre commande. (L'anneau Möbius est imprimé par défaut dans le coin supérieur gauche.)

ES > El porcentaje está calculado basado en el peso total del producto.
Añade el Möbius loop a tu arte final sin cargo adicional. Por favor asegúrate de especificar "imprimir el Möbius loop" en tu pedido. (La impresión del Möbius loop a mano izquierda en la esquina)

DE > Der Prozentsatz ist auf der Grundlage des Gesamtgewichts des Produkts berechnet. Zu Artwork Möbius-Loop hinzufügen, ohne Zusatzkosten.
Vergessen Sie nicht "Möbius-Loop drucken" auf der Bestellung anzugeben (Möbius-Loop-Aufdruck standardmäßig auf der linken Ecke).

IT > La percentuale è calcolata in base al peso totale del prodotto.
Aggiungi l'anello di Möbius al tuo disegno senza costi aggiuntivi. Assicurati di specificare "Stampare anello di Möbius" nel tuo ordine. (La stampa dell'anello di Möbius va in default nell'angolo sinistro)



1210



MOQ 250v.

Decoration:

Personalisation / Personalización / Dekoration / Decorazione

BIC® Permanent Marker eCOlutions® 1210

A SP: max. 1 col.

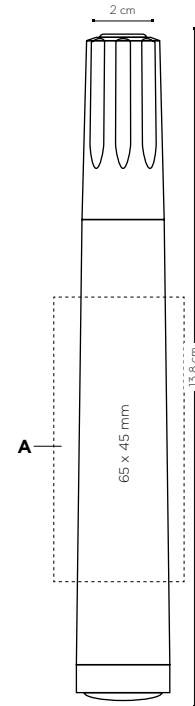

Colour ink
Encre de couleur
Color de la tinta
Schreibfarbe
Colore inchiostro

O2

O2

100%

eCOlutions® Made with 51% recycled material.

Price (€)

BIC® Permanent Marker

eCOlutions®

1210

SP	1,71	1,56	1,44	1,35	1,26	①	①
	250-499	500-999	1000-2499	2500-4999	5000-9999	10000-24999	25000-49999

Prices include 1 colour screenprint in one position. Les prix incluent la sérigraphie 1 couleur sur un emplacement. En precio incluye un color en serigrafía en una posición. In den Preisen inbegriffen ist 1 Siebdruck-Farbaufdruck auf 1 Position. I prezzi includono 1 colore a serigrafia in una posizione.

① Price under request. Prix sur demande. Precio bajo consulta. Preis auf Anfrage. Prezzi su richiesta.

Writing modes:

Mode écriture / Modos de escritura / Schreibmodi / Modalità di scrittura

Marker



MK

Printing techniques:

Techniques d'impression / Técnicas de impresión / Drucktechniken / Tecniche di stampa



(SP) SCREEN PRINTING

External packaging:

Emballage externe / Envasado exterior / Außenverpackung / Imballaggio esterno



250 ± 2,6 Kg



MADE IN FRANCE

HIGHLIGHTERS & MARKERS
BIC® WRITING INSTRUMENTS



Stay sharp with this first-class mechanical pencil!
It is solid and resistant, never needs sharpening
and writes smoother and darker than ever!

FR > Toujours prêt avec ce
porte-mines de grande qualité.
Il est solide et la mine est
résistante. Il n'a pas besoin d'être
taillé et offre une écriture plus
fluide et plus intense que jamais !

ES > Siempre preparado con este
portaminas de calidad superior.
Es sólido y resistente, no necesita
afilarse y escribe más fluido e
intenso que nunca!

DE > Stets schreibbereit mit
diesem Qualitäts-Druckbleistift.
Solide und resistent, ohne
Anspitzen, schreibt dieser Stift
leichter und kräftiger denn je!

IT > Non perderti questo
portamine di prima categoria.
Compatto e resistente, non si
tempera e scrive più fluido e
scuro che mai!







BIC® Matic®
OPAQUE - 1120



01/01

01/12

01/03

01/05

01/04

01/02

02/02

100%

BIC® WRITING INSTRUMENTS
PENCILS





ecolutions® Made with 65% recycled material.
 The percentage is calculated based on the total weight of the product.
 Add the Möbius loop to your artwork at no additional charge. Please be sure to specify "Print the Möbius loop" on your order. (Möbius loop imprint defaults to left-hand hand corner.)



PENCILS
 BIC® WRITING INSTRUMENTS

FR > Le pourcentage est calculé sur le poids total du produit.
 Ajoutez l'anneau Möbius à votre article sans frais supplémentaire. N'oubliez pas de préciser « Imprimer l'anneau Möbius » dans votre commande. (L'anneau Möbius est imprimé par défaut dans le coin supérieur gauche)

ES > El porcentaje está calculado basado en el peso total del producto.
 Añade el Möbius loop a tu arte final sin cargo adicional. Por favor asegúrate de especificar "imprimir el Möbius loop" en tu pedido. (La impresión del Möbius loop a mano izquierda en la esquina)

DE > Der Prozentsatz ist auf der Grundlage des Gesamtgewichts des Produkts berechnet.
 Zu Artwork Möbius-Loop hinzufügen, ohne Zusatzkosten.
 Vergessen Sie nicht "Möbius-Loop drucken" auf der Bestellung anzugeben (Möbius-Loop-Aufdruck standardmäßig auf der linken Ecke).

IT > La percentuale è calcolata in base al peso totale del prodotto.
 Aggiungi l'anello di Möbius al tuo disegno senza costi aggiuntivi. Assicurati di specificare "Stampare anello di Möbius" nel tuo ordine. (La stampa dell'anello di Möbius va in default nell'angolo sinistro)





BIC® Matic® Quartz
OPAQUE - 1121



51/01

51/03



51/04

100%

BIC® Matic® Quartz Metallic



51/07

51/18

BIC® Matic® Grip
OPAQUE - 1122



01/04

01/02

BIC® Matic® Grip Metallic



02/02

100%

BIC® WRITING INSTRUMENTS

PENCILS

MOQ 500v.

Decoration:

Personalisation / Personalización /
Dekoration / Decorazione

BIC® Matic®
1120
e@colutions® 1E40

BIC® Matic®
Quartz & Metallic
1121

A SP: max. 1 col. (not available
for BIC® Matic® Quartz)

B/C SP: max. 2 col.

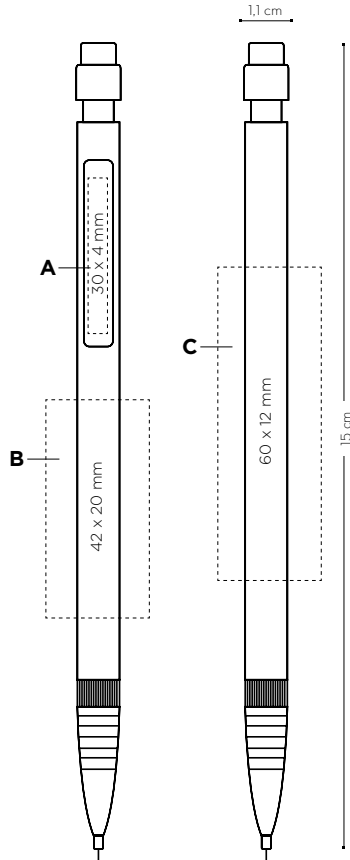

BIC® Matic® Grip &
Metallic
1122

A SP: max. 1 col.
B/C SP: max. 2 col.

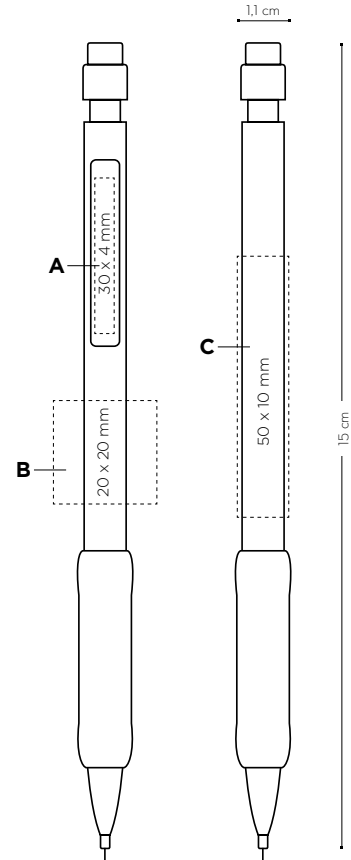

e@colutions® version & STD
at the same price!



Price (€)

	500-4999	1000-24999	2500-49999	50000-99999	100000-249999	250000-499999
BIC® Matic® Quartz & Metallic 1120/e@colutions® 1E40						
SP	0,76	0,71	0,66	0,62	0,58	0,54
1121						
SP	0,83	0,76	0,71	0,67	0,63	0,59

ADDITIONAL IMPRINT CHARGE PER COLOUR & POSITION frais d'impression supplémentaires par couleur et position / cargo por impresión adicional por color y posición / zusätzliche druckkosten pro farbe & position / costo marchio aggiuntivo per colore e posizione

SP	0,13	0,13	0,13	0,12	0,11	0,11
-----------	------	------	------	------	------	------

Prices include 1 colour screenprint in one position. Les prix incluent la sérigraphie 1 couleur sur un emplacement. En precio incluye un color en serigrafía en una posición. In den Preisen inbegriffen ist 1 Siebdruck-Farbaufdruck auf 1 Position. I prezzi includono 1 colore a serigrafia in una posizione.

Price (€)

	500-4999	1000-24999	2500-49999	50000-99999	100000-249999	250000-499999
BIC® Matic® Grip & Metallic 1122						
SP	0,91	0,85	0,80	0,74	0,69	0,64

ADDITIONAL IMPRINT CHARGE PER COLOUR & POSITION frais d'impression supplémentaires par couleur et position / cargo por impresión adicional por color y posición / zusätzliche druckkosten pro farbe & position / costo marchio aggiuntivo per colore e posizione

SP	0,13	0,13	0,13	0,12	0,11	0,11
-----------	------	------	------	------	------	------

Prices include 1 colour screenprint in one position. Les prix incluent la sérigraphie 1 couleur sur un emplacement. En precio incluye un color en serigrafía en una posición. In den Preisen inbegriffen ist 1 Siebdruck-Farbaufdruck auf 1 Position. I prezzi includono 1 colore a serigrafia in una posizione.

Writing modes:

Mode écriture / Modos de escritura /
Schreibmodi / Modalità di scrittura



MP
Ø0,7mm

Printing techniques:

Techniques d'impression / Técnicas de impresión /
Drucktechniken / Tecniche di stampa



**(SP) SCREEN
PRINTING**

External packaging:

Emballage externe / Envasado exterior /
Außenverpackung / Imballaggio esterno



500 ± 3,1 Kg



**MADE IN
FRANCE**

Wood-free pencil made with recycled synthetic resin material, that will not splinter in the event of breaking. Ultra-resistant HB graphite lead and excellent erasability!

FR > Crayon papier en résine synthétique, sans bois, qui ne fait pas d'éclat en cas de casse. Mine graphite HB ultra-résistante qui s'efface rapidement !

ES > Lápiz de grafito de resina sintética, sin madera, hecho con un material reciclado, que no se astilla en caso de rotura. Resistente mina de grafito HB y excelente calidad de borrado!

DE > Holzfreier Bleistift aus recyceltem Kunstharzmaterial, das nicht splittert, wenn es bricht. Extrem robuste HB-Graphitmine! Lässt sich hervorragend ausradieren!

IT > Matita senza legno realizzata in resina sintetica riciclata che non produce schegge in caso di rottura. Mina HB in grafite ultrasensibile ed eccellente cancellabilità!





GRAPHITE PENCIL CUT END
1150



01

03

04

20

02

GRAPHITE PENCIL WITH ERASER
1151



01

03

04

20

02



100%

100%



PENCILS
BIC® WRITING INSTRUMENTS



Digital Printing!

Digital
GRAPHITE PENCIL
CUT END - 1150



01



Metallic Digital
GRAPHITE PENCIL
CUT END - 1962



47



Digital
GRAPHIC PENCIL
WITH ERASER - 1151



01



Metallic Digital
GRAPHIC PENCIL
WITH ERASER - 1960



47



MOQ 500v.



Standard colours combination

Combinaison de couleurs standards / Combinación de colores estandar / Standardfarbkombination / Combinazione colori standard

Eraser

Gomme / Goma / Radiergummi / Gomma

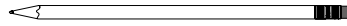

Ferrule

Virole / Ferrula / Ferrule / Ghiera

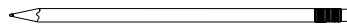

Barrel

Corps / Cuerpo / Schaft / Fusto

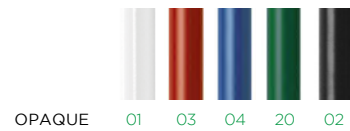

METALLIC



GRAPHITE PENCIL CUT END



Made with 54% recycled plastic

GRAPHITE PENCIL WITH ERASER



Made with 46% recycled plastic

The percentage is calculated based on the total weight of the product.

Add the Möbius loop to your artwork at no additional charge. Please be sure to specify "Print the Möbius loop" on your order. (Möbius loop imprint defaults to left-hand hand corner.)

FR > Le pourcentage est calculé sur le poids total du produit. Ajoutez l'anneau Möbius à votre article sans frais supplémentaire. N'oubliez pas de préciser « Imprimer l'anneau Möbius » dans votre commande. (L'anneau Möbius est imprimé par défaut dans le coin supérieur gauche)

ES > El porcentaje está calculado basado en el peso total del producto. Añade el Möbius loop a tu arte final sin cargo adicional. Por favor asegúrate de especificar "imprimir el Möbius loop" en tu pedido. (La impresión del Möbius loop a mano izquierda en la esquina)

DE > Der Prozentsatz ist auf der Grundlage des Gesamtgewichts des Produkts berechnet. Zu Artwork Möbius-Loop hinzufügen, ohne Zusatzkosten. Vergessen Sie nicht "Möbius-Loop drucken" auf der Bestellung anzugeben (Möbius-Loop-Aufdruck standardmäßig auf der linken Ecke).

IT > La percentuale è calcolata in base al peso totale del prodotto. Aggiungi l'anello di Möbius al tuo disegno senza costi aggiuntivi. Assicurati di specificare "Stampare anello di Möbius" nel tuo ordine. (La stampa dell'anello di Möbius va in default nell'angolo sinistro)

Writing modes:

Mode écriture / Modos de escritura / Schreibmodi / Modalità di scrittura



PC HB Ø2,3mm

Printing techniques:

Techniques d'impression / Técnicas de impresión / Drucktechniken / Tecniche di stampa



(SP) SCREEN PRINTING



(DG) DIGITAL

External packaging:

Emballage externe / Envasado exterior / Außenverpackung / Imballaggio esterno



500 ± 3,5 Kg



MADE IN FRANCE



BIC® EVOLUTION® eCOlutions®
PENCIL WITH CUT END
1150

BIC® EVOLUTION® eCOlutions®
PENCIL WITH ERASER
1151

A SP: max. 1 col.
B SP: max. 2 col.

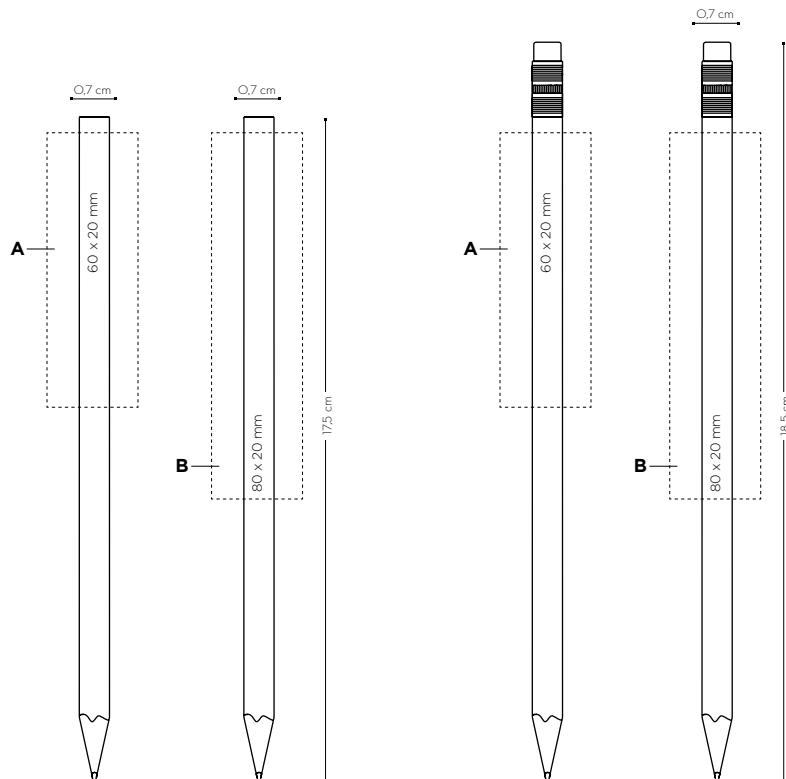

BIC® WRITING INSTRUMENTS
PENCILS

Price (€)

BIC® EVOLUTION® eCOlutions®	500-111	1000-2411	2500-4111	5000-1111	10000-2411	25000-1111
PENCIL WITH CUT END / 1150						
SP	0,43	0,41	0,38	0,36	0,34	0,32
PENCIL WITH ERASER / 1151						
SP	0,73	0,68	0,64	0,60	0,56	0,52

ADDITIONAL IMPRINT CHARGE PER COLOUR & POSITION frais d'impression supplémentaires par couleur et position / cargo por impresión adicional por color y posición / zusätzliche druckkosten pro farbe & position / costo marchio aggiuntivo per colore e posizione

SP	0,13	0,13	0,13	0,12	0,11	0,11
-----------	------	------	------	------	------	------

Prices include 1 colour screenprint in one position. Les prix incluent la sérigraphie 1 couleur sur un emplacement. En precio incluye un color en serigrafía en una posición. In den Preisen inbegriffen ist 1 Siebdruck-Farbaufdruck auf 1 Position. I prezzi includono 1 colore a serigrafia in una posizione.

External packaging:

Emballage externe / Envasado exterior / Außenverpackung / Imballaggio esterno



500 ± 3,5 Kg



MADE IN FRANCE



BIC® Evolution® **ecolutions®**
 PENCIL WITH CUT END
 1150 Digital
 1962 Metallic Digital

BIC® Evolution® **ecolutions®**
 PENCIL WITH ERASER DIGITAL
 1151
 PENCIL WITH ERASER
 METALLIC DIGITAL
 1960

A DG: full-colour (area for images)
B DG: full-colour (area for text)

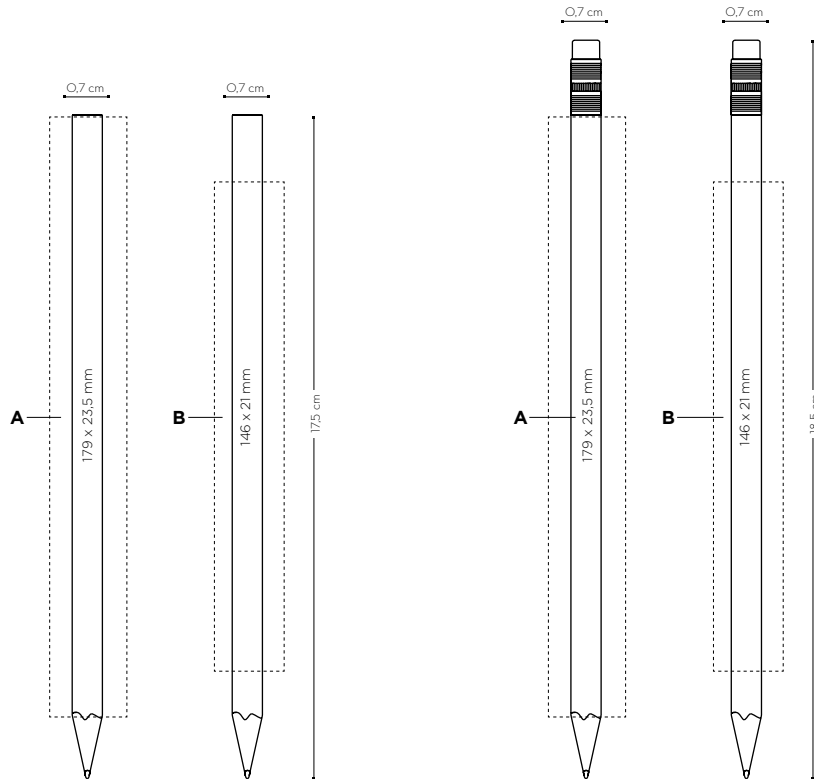

PENCILS
 BIC® WRITING INSTRUMENTS

	Price (€)							
BIC® Evolution® ecolutions®	250-499	500-999	1000-2499	2500-4999	5000-9999	10000-24999	25000-49999	
PENCIL WITH CUT END DIGITAL / 1150								
DG	-	0,67	0,64	0,59	0,55	①	①	
PENCIL WITH CUT END METALLIC / 1962								
DG	-	0,80	0,75	0,69	0,64	①	①	
PENCIL WITH ERASER DIGITAL / 1151								
DG	-	0,97	0,91	0,85	0,79	①	①	
PENCIL WITH ERASER METALLIC DIGITAL / 1960								
DG	-	1,10	1,03	0,96	0,89	①	①	

Prices include digital imprint on barrel. Les prix incluent l'impression numérique sur le corps. El precio incluye impresión digital en el cuerpo. Preise beinhalten Digitaldruck auf dem Schaft. I prezzi comprendono la stampa digitale sul fusto.
 ① Price under request. Prix sur demande. Precio bajo consulta. Preis auf Anfrage. Prezzi su richiesta.

External packaging:
 Emballage externe / Envasado exterior /
 Außenverpackung / Imballaggio esterno



Sprout®



Customized Sprout pencils are used by companies and organisations all over the world to spread their sustainability message.

Once the pencil is too short to write with, plant the stub and watch your message turn into a pot of beautiful herbs, flowers or vegetables.

FR > Les crayons Sprout personnalisables sont utilisés par les entreprises et les organisations du monde entier pour communiquer leur respect de l'environnement. Une fois que le crayon est trop court pour écrire, plantez-le et regardez votre message se transformer en superbe pot d'herbes aromatiques, de fleurs ou de légumes.

ES > Los lápices Sprout personalizables son usados por la compañías y organizaciones en todo el mundo para difundir su mensaje de sostenibilidad. Una vez que el lápiz es demasiado corto para escribir, plántalo por la parte de arriba y mira como tu mensaje se convierte en una maceta de hermosas hierbas, flores o vegetales.

DE > Die kundenspezifisch anpassbaren Sprout-Bleistifte werden von Unternehmen und Organisationen weltweit genutzt, um ihre Nachhaltigkeitsbotschaft zu übermitteln. Wenn der Stift zum Schreiben zu kurz geworden ist, pflanzen Sie den Stummel ein und sehen Sie, wie Ihre Botschaft zu einem Topf schöner Kräuter, Blumen oder Gemüse wird.

IT > Le matite personalizzate Sprout sono utilizzate da società e organizzazioni di tutto il mondo per diffondere il proprio messaggio di sostenibilità. Quando la matita diventa troppo corta per scrivere, si può piantare trasformando il proprio messaggio in un bellissimo vaso di erbe aromatiche, fiori o verdure.





SPROUT™



Sprouta Pencil

Combine them!

Non-customizable cardboard

Customizable cardboard

53062



Non printed barrel



Printed barrel

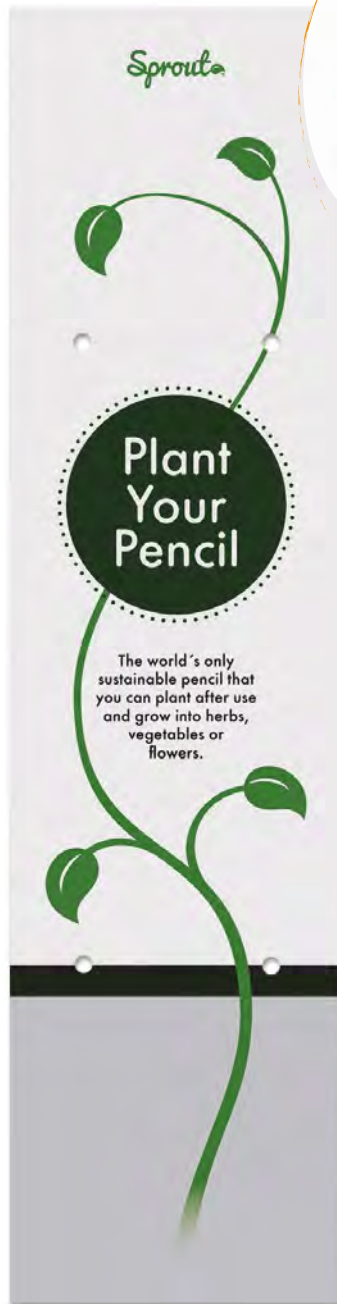

Standard cardboard packaging



back

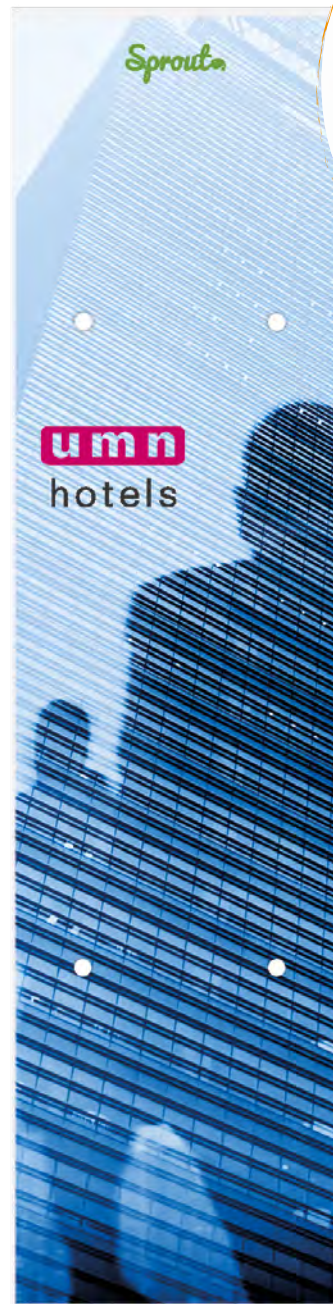

Personalised cardboard packaging



back

80%

FR > Emballage non personnalisable
Emballage personnalisable !

ES > Cartón no personalizable
¡Cartón personalizable!

DE > Pappe kann nicht an
Kundenwünsche angepasst werden!
Pappe kann an Kundenwünsche
angepasst werden!

IT > Cartone non personalizzabile
Cartone personalizzabile!





MOQ 500

MOQ 1000 (Non printed pencil + personalised cardboard packaging)

Decoration:

Personnalisation / Personalización / Dekoration / Decorazione

Sprout™ Pencil

53062

A LE

B DG: 4-colour process

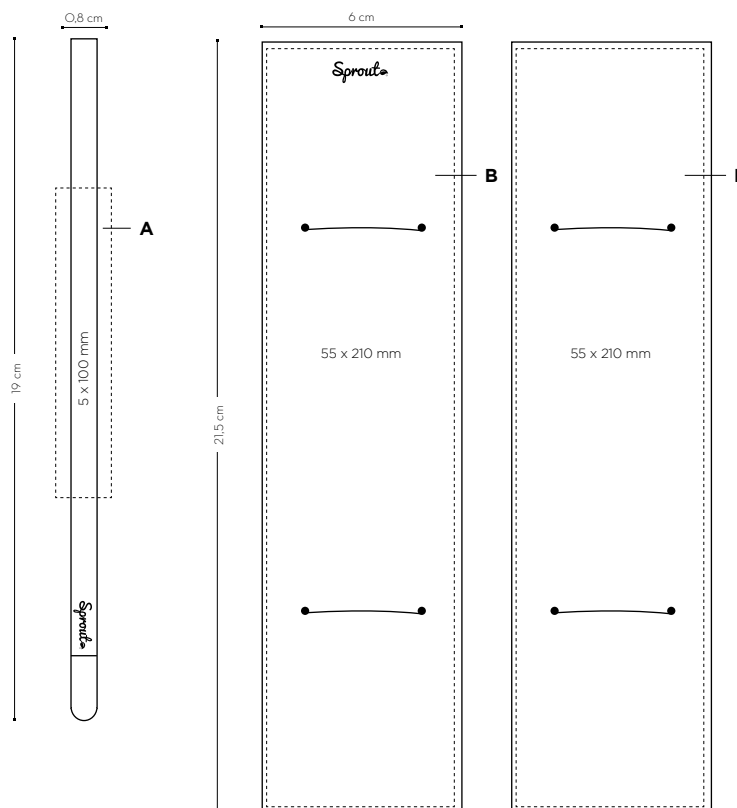

SPROUT™

Writing modes:

Mode écriture / Modos de escritura / Schreibmodi / Modalità di scrittura

Pencil



PC
HB Ø2,3mm

Printing techniques:

Techniques d'impression / Técnicas de impresión / Drucktechniken / Tecniche di stampa



(DG) DIGITAL



(LE) LASER

External packaging:

Emballage externe / Envasado exterior / Außenverpackung / Imballaggio esterno



500 ± 2,5 Kg Only pencil
± 5 Kg with cardboard packaging

Check out the video

Regardez la video / Mira el video / Produktvideo / Guarda il video





BIC® COLOURING

Set of 6 colouring pens with bright colours supported by the recognised BIC® brands: PLASTIDECOR®, EVOLUTION® and VISA®. Presented in a fully customized carton wallet, this is an ideal promotional item for children and teenagers!

FR > Set de 6 crayons aux couleurs vives sous les célèbres marques BIC® : PLASTIDECOR®, EVOLUTION® et VISA®. Présenté dans une pochette carton totalement personnalisée. Un article de promotion idéal pour les enfants et les ados !

DE > Set aus 6 Buntstiften mit leuchtenden Farben der bekannten BIC®-Marken: PLASTIDECOR®, EVOLUTION® und VISA®. Präsentiert in einem ganz den Kundenwünschen angepassten Etui aus Karton. Ein idealer Werbeartikel für Kinder und Jugendliche!

ES > Set de 6 lápices con colore brillantes bajo el soporte de las reconocidas marcas BIC®: PLASTIDECOR®, EVOLUTION® y VISA®. Presentado en una funda de carton totalmente personalizable, ésta es una idea de producto promocional tanto para niños como adolescentes!

IT > Set di 6 pastelli in vivaci colori con i famosissimi marchi BIC®: PLASTIDECOR®, EVOLUTION® e VISA®. Presentato in un astuccio di cartone personalizzato, è l'articolo promozionale ideale per bambini e teenager!



BIC® PLASTIDECOR® Set of 6 crayons



COLOURING CRAYONS 1201



100%

MOQ 500u.

Decoration:

Personnalisation / Personalización / Dekoration / Decorazione

BIC® PLASTIDECOR® Set of 6 crayons 1201

A DG: 4-colour process

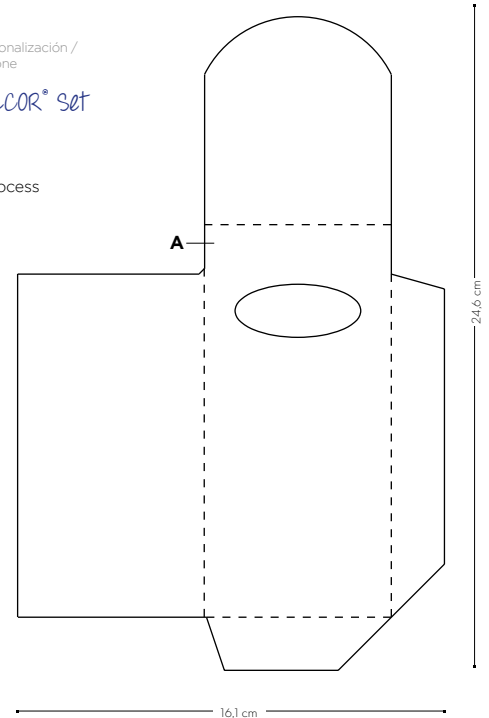

COLOURING PENS
BIC® WRITING INSTRUMENTS

Price (€)

BIC® PLASTIDECOR® Set of 6 crayons 1201	500-444	1000-2444	2500-4444	5000-4444	10000-24444	25000-44444
DG	3,17	2,39	1,96	1,71	①	①

All BIC® Colouring pens include 4-colour process printing on the carton wallet. Toute la gamme BIC® Colouring inclut l'impression en quadrichromie sur la pochette en carton. Toda la gama de BIC® Colouring incluye impresión en cuatricromía en el funda de cartón. Bei allen BIC® Colouring Malstiften ist Vierfarbdruck auf dem Kartonnetui inbegriffen. Tutti i pennarelli per colorare BIC® comprendono il processo di stampa a 4 colori sulla custodia in cartone.

① Price under request. Prix sur demande. Precio bajo consulta. Preis auf Anfrage. Prezzi su richiesta.

Writing modes:

Mode écriture / Modos de escritura / Schreibmodi / Modalità di scrittura



Packaging:

emballage / envasado / verpackung / imballaggio



Printing techniques:

Techniques d'impression / Técnicas de impresión / Drucktechniken / Tecniche di stampa



(DG) DIGITAL

External packaging:

Emballage externe / Envasado exterior / Außenverpackung / Imballaggio esterno



84 ± 3,8 Kg



MADE IN FRANCE

BIC® Visa® set of 6 felt pens



*Except black ink
*Sauf l'encre noire

FELT PENS 1203

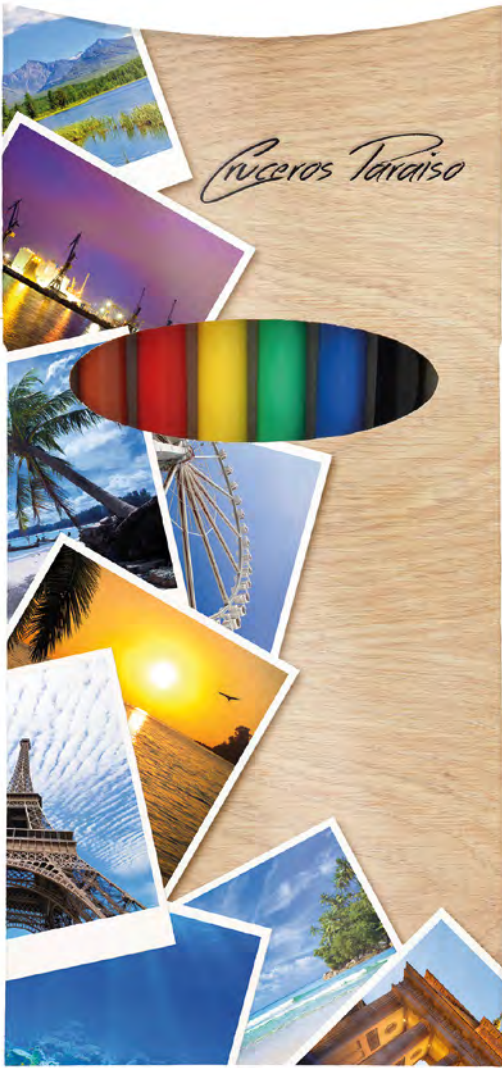

MOA 500V.

Decoration:

Personnalisation / Personalización /
Dekoration / Decorazione

BIC® VISA® set of 6 felt pens
1203

A DG: 4-colour process

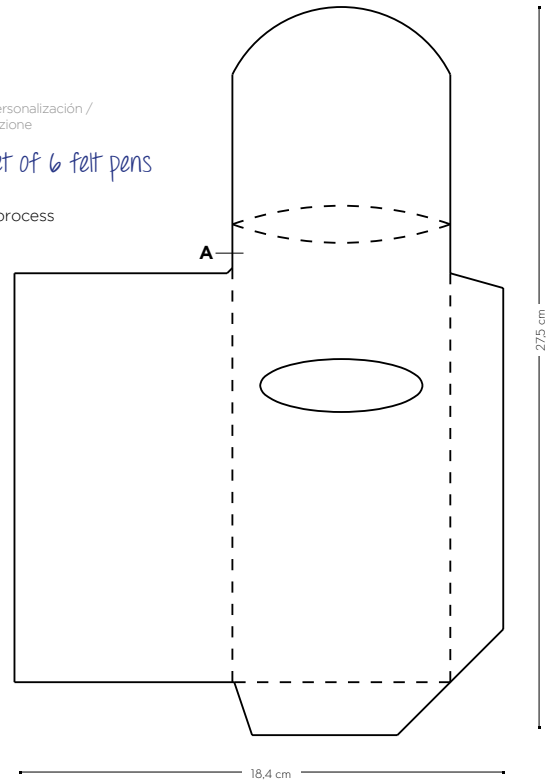

Price (€)

BIC® VISA® set of 6 felt pens	500-499	1000-2499	2500-4999	5000-9999	10000-24999	25000-49999
1203						
DG	4,52	3,67	3,23	2,86	①	①

All BIC® Colouring pens include 4-colour process printing on the carton wallet. Toute la gamme BIC® Colouring inclut l'impression en quadrichromie sur la pochette en carton. Toda la gama de BIC® Colouring incluye impresión en cuatricromia en el funda de cartón. Bei allen BIC® Colouring Malstiften ist Vierfarbdruck auf dem Kartonetui inbegriffen. Tutti i pennarelli per colorare BIC® comprendono il processo di stampa a 4 colori sulla custodia in cartone.

① Price under request. Prix sur demande. Precio bajo consulta. Preis auf Anfrage. Prezzi su richiesta.

BIC® WRITING INSTRUMENTS
COLOURING PENS

Writing modes:

Mode écriture / Modos de escritura /
Schreibmodi / Modalità di scrittura



Packaging:

emballage / envasado /
verpackung / imballaggio



01

Printing techniques:

Techniques d'impression / Técnicas de impresión /
Drucktechniken / Tecniche di stampa



(DG) DIGITAL

External packaging:

Emballage externe / Envasado exterior /
Außenverpackung / Imballaggio esterno



60 ± 2,4 Kg



MADE IN FRANCE



Set of 6 colouring pencils

COLOURING PENCILS 1202



*Made with 50% recycled material.

80%

easy to sharpen!

- FR > facile à affûter !
- ES > ¡Fácil de afilar!
- DE > Leicht anzuspitzen!
- IT > Facile da temperare!



MOQ 500v.

Decoration:

Personnalisation / Personalización / Dekoration / Decorazione

BIC® Evolution® Ecollections®
Set of 6 colouring pencils
1202

A DG: 4-colour process

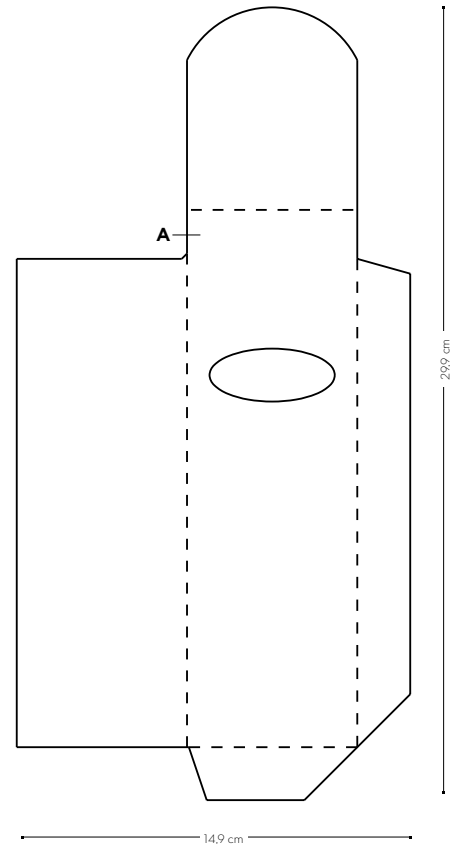

Price (€)

BIC® evolution® ecollections®
Set of 6 colouring pencils

1202

DG	3,33	2,51	2,06	1,80	①	①
-----------	------	------	------	------	---	---

All BIC® Colouring pens include 4-colour process printing on the carton wallet. Toute la gamme BIC® Colouring inclut l'impression en quadrichromie sur la pochette en carton. Toda la gama de BIC® Colouring incluye impresión en cuatricromía en el funda de cartón. Bei allen BIC® Colouring Malstiften ist Vierfarbdruck auf dem Kartonetui inbegriffen. Tutti i pennarelli per colorare BIC® comprendono il processo di stampa a 4 colori sulla custodia in cartone.

① Price under request. Prix sur demande. Precio bajo consulta. Preis auf Anfrage. Prezzi su richiesta.

Writing modes:

Mode écriture / Modos de escritura / Schreibmodi / Modalità di scrittura



Packaging:

emballage / envasado / verpackung / imballaggio



C019520

01

Printing techniques:

Techniques d'impression / Técnicas de impresión / Drucktechniken / Tecniche di stampa



(DG) DIGITAL

External packaging:

Emballage externe / Envasado exterior / Außenverpackung / Imballaggio esterno



60 ± 2,6 Kg



MADE IN FRANCE

COLOURING PENS
BIC® WRITING INSTRUMENTS



Set of 6 colouring pencils

Did you know?

Conté brand was founded more than 220 years back and is named after its founder, Nicolas - Jacques Conté. Born in France in 1755, he is considered as the inventor of "modern" pencil lead.

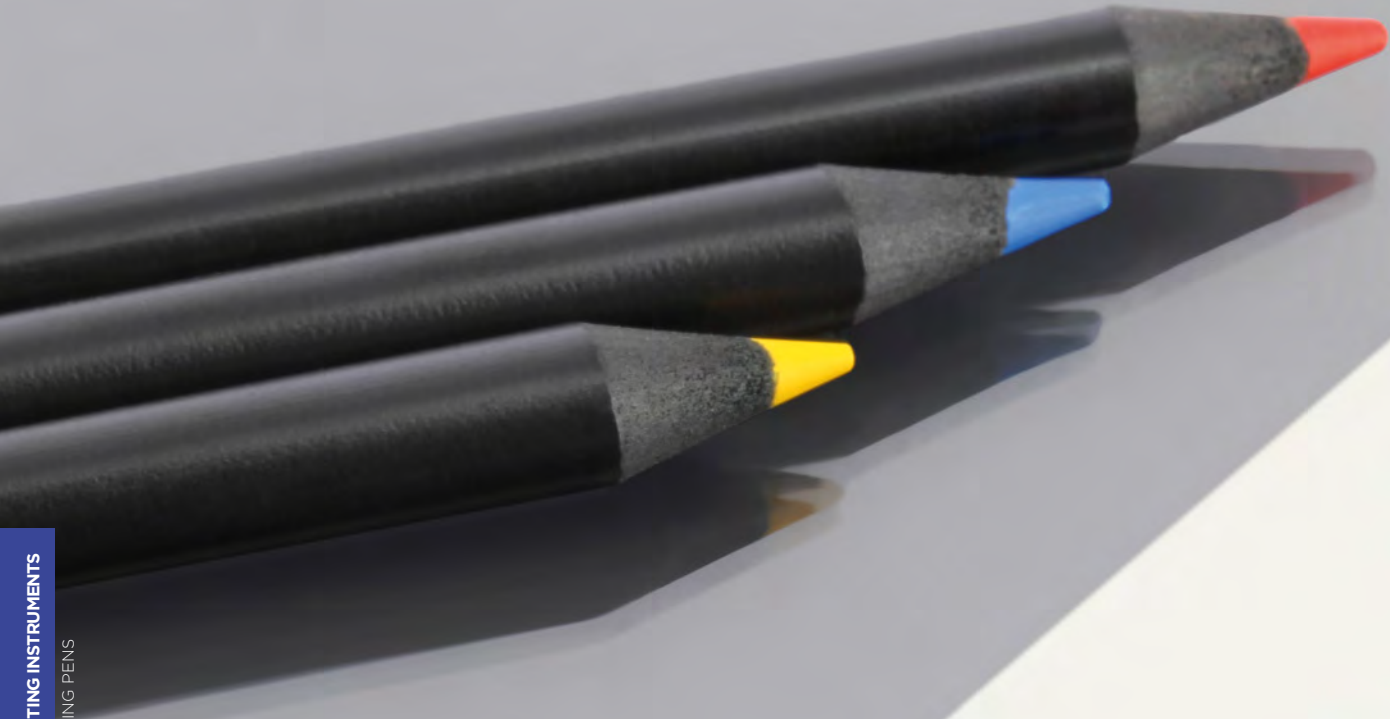

FR > Saviez-vous que ?
Conté® en tant que marque a été créée il y a plus de 220 ans et porte le nom de son fondateur, Nicolas-Jacques Conté. Né en France en 1755, il est considéré comme l'inventeur de la mine "moderne" du crayon à papier.

DE > Wussten Sie,
dass Conté vor mehr als 220 Jahren gegründet und nach dem Gründer, Nicolas-Jacques Conté, benannt wurde?
Er wurde 1755 in Frankreich geboren und gilt als der Erfinder der "modernen" Bleistiftmine.

ES > ¿Sabias que? La marca Conté se fundó hace más de 220 años y lleva el nombre de su fundador Nicolas - Jaques Conté. Nacido en Francia en 1755, es considerado como el inventor de la "pluma moderna"

IT > Lo sapevi?
Il marchio Conté è stato fondato più di 220 anni fa e prende il nome dal suo fondatore, Nicolas - Jacques Conté. Nato in Francia nel 1755, è considerato l'inventore della mina per matita "moderna".





Set of 6 colouring pencils



Strong lead



Vibrant Colours



COLOURING PENCILS 1178



MOQ 500v.

Decoration:

Personalisation / Personalización /
Dekoration / Decorazione

Conté® set of 6 colouring pencils
1178

A DG: 4-colour process



Wood free pencils

FR > crayons sans bois

ES > Lápices libres de madera

DE > Holzfreie Buntstifte

IT > matite senza legno

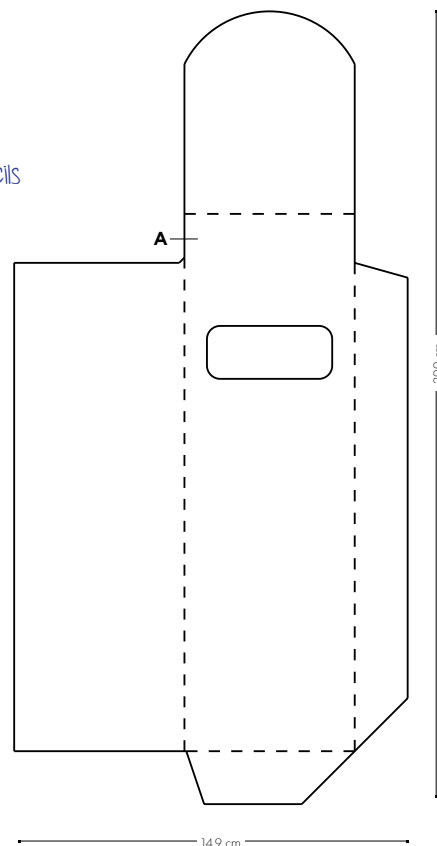

Price (€)

Conté® Set of 6 colouring pencils 1178	500-499	1000-2499	2500-4999	5000-9999	10000-24999	25000-49999
DG	3,70	2,87	2,46	2,11	①	①

All BIC® Colouring pens include 4-colour process printing on the carton wallet. Toute la gamme BIC® Colouring inclut l'impression en quadrichromie sur la pochette en carton. Toda la gama de BIC® Colouring incluye impresión en cuatricromía en el funda de cartón. Bei allen BIC® Colouring Malstiften ist Vierfarbdruck auf dem Kartonetui inbegriffen. Tutti i pennarelli per colorare BIC® comprendono il processo di stampa a 4 colori sulla custodia in cartone.

① Price under request. Prix sur demande. Precio bajo consulta. Preis auf Anfrage. Prezzi su richiesta.

Writing modes:

Mode écriture / Modos de escritura /
Schreibmodi / Modalità di scrittura



Packaging:

emballage / envasado /
verpackung / imballaggio



Printing techniques:

Techniques d'impression / Técnicas de impresión /
Drucktechniken / Tecniche di stampa



(DG) DIGITAL

External packaging:

Emballage externe / Envasado exterior /
Außenverpackung / Imballaggio esterno



60 ± 2,2 Kg



MADE IN FRANCE

COLOURING PENS
BIC® WRITING INSTRUMENTS





Colouring set

Create your fully customized colouring set: your favourite colouring set of pencils, a colouring book for kids or adults, and a nice cotton drawstring bag with BIC® logo.

FR > Créez votre set de coloriage totalement personnalisé : vos crayons de couleur favoris, un cahier de coloriage pour les enfants et les adultes, et un sac en coton à cordon coulissant, orné du logo BIC®.

ES > Crea tu set de colores totalmente personalizado: tu set de lápices de colores favoritos, un libro para colorear para niños o para adultos y una bonita bolsa con cordones con el logo BIC®.

DE > Kreieren Sie Ihr ganz individuelles Mal-Set: Ihr Lieblingssatz Buntstifte, ein Malbuch für Kinder oder Erwachsene und ein schöner Zugbeutel aus Baumwolle mit BIC®-Logo.

IT > Crea il tuo set per colorare completamente personalizzato: i tuoi pastelli preferiti, un libro da colorare per bambini o adulti e una bellissima borsa in cotone con chiusura a cordoncino e logo BIC® impresso.



COLOURING PENS
BIC® WRITING INSTRUMENTS



Colouring set

Create your own combination

 **PLASTIDÉCOR**® Set of 6 crayons,  **Visa**® Set of 6 felt pens or  **EVOLUTION**® **ecolutions**® Set of 6 colouring pencils



35%

Writing modes:

Mode écriture / Modos de escritura / Schreibmodi / Modalità di scrittura



Packaging:

emballage / emvasado / verpackung / imballaggio

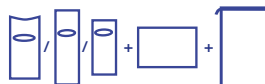

Printing techniques:

Techniques d'impression / Técnicas de impresión / Drucktechniken / Tecniche di stampa



(SP) SCREEN PRINTING



(OT) OFFSET TRANSFER

MOQ 500v.

Decoration:

Personalisation / Personalización / Dekoration / Decorazione

BIC® PLASTIDECOR®
colouring set
1294



BOX

C DG: 4-colour process

Bag

No imprint (bag)

A SP (bag): max 2 col.

B OT (bag): full-colour

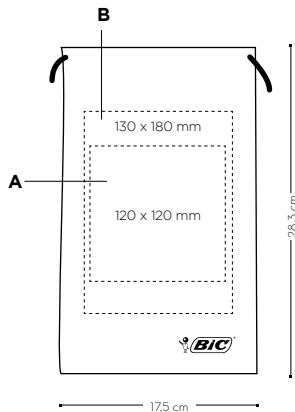

Book

C DG: 4-colour process

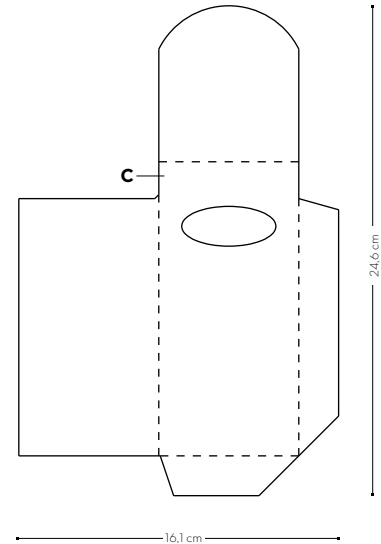
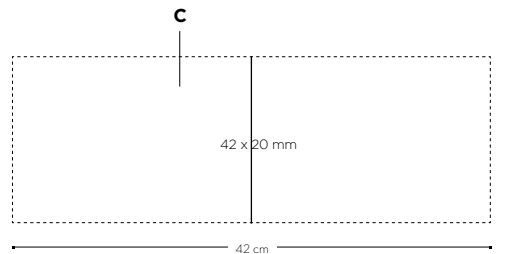

**BIC® PLASTIDECOR®
colouring set 1294**

	500-499	1000-2499	2500-4999	5000-9999	10000-24999	25000-49999
No imprint (bag)	9,82	7,07	5,65	4,74	①	①
SP (bag)	10,69	7,79	6,31	5,39	①	①
OT (bag)	11,62	8,69	7,20	6,28	①	①

ADDITIONAL IMPRINT CHARGE PER COLOUR & POSITION frais d'impression supplémentaires par couleur et position / cargo por impresión adicional por color y posición / zusätzliche druckkosten pro farbe & position / costo marchio aggiuntivo per colore e posizione

SP	0,87	0,72	0,66	0,65	①	①
OT	1,80	1,62	1,55	1,54	①	①

BIC® Colouring Pens sets are composed of a carton wallet, a coloring book and a cotton drawstring bag with BIC® logo. Prices include full colour personalisation on the carton box and the coloring book. Imprint on the bag is optional. Prices above vary according to the personalisation technique chosen for the bag. Les sets de coloriage BIC® Colouring sont composés d'une boîte à crayons de couleur, d'un cahier de coloriage et d'un sac en coton à cordon coulissant portant le logo BIC®. Le prix inclut la personnalisation complète de la boîte à crayons et du cahier de coloriage. L'impression sur le sac est en option. Les prix ci-dessus varient en fonction de la technique de personnalisation choisie pour le sac / El set de colores BIC® está compuesto de una funda de cartón, un libro para colorear y una bolsa con cordones con el logo BIC®. Los precios incluyen personalización a todo color en la funda de cartón y en el libro para colorear. La impresión de la bolsa es opcional. Los precios de arriba varían acorde de la técnica de personalización escogida para la bolsa / BIC® Colouring-Malstiftsets bestehen aus einem Kartonset, einem Malbuch und einem Zugbeutel aus Baumwolle mit BIC®-Logo. In den Preisen inbegriffen ist Vierfarbdruck-Personalisierung auf Karton und Malbuch. Aufdruck auf dem Beutel auf Wunsch. Die oben angegebenen Preise können je nach für den Beutel gewählter Personalisierungstechnik variieren / I set di penne per colorare BIC® comprendono una custodia in cartone, un quaderno per colorare e una borsa in cotone con chiusura a cordoncino e logo BIC® impresso. I prezzi includono la personalizzazione a colori sulla scatola di cartone e sul quaderno per colorare. La stampa sulla borsa è opzionale. I suddetti prezzi possono variare in base alla tecnica di personalizzazione scelta per la borsa.

① Price under request. Prix sur demande. Precio bajo consulta. Preis auf Anfrage. Prezzi su richiesta.

External packaging:

Emballage externe / Envasado exterior / Außenverpackung / Imballaggio esterno



100 ± 10,8 Kg



BIC® Colouring set



BIC® VISA®
Colouring set
1291

BOX
C DG: 4-colour process

Bag
No imprint (bag)
A SP (bag): max 2 col.
B OT (bag): full-colour

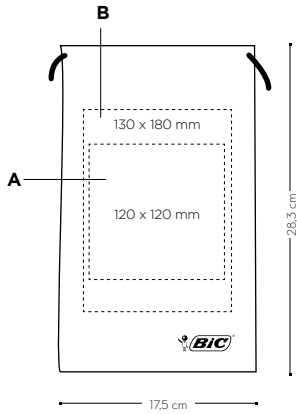

Book
C DG: 4-colour process

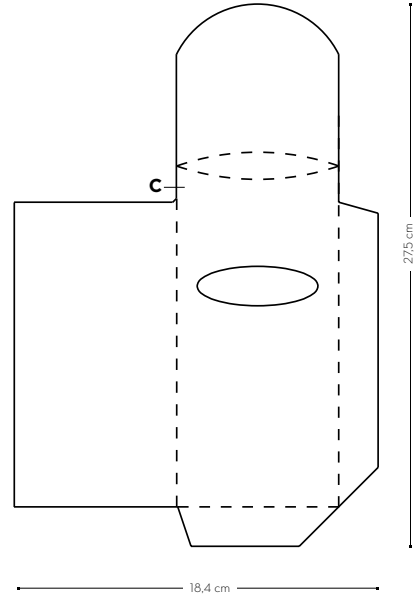
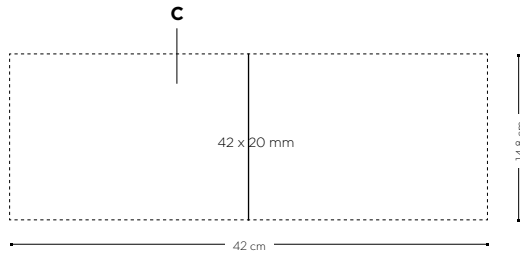

BIC® WRITING INSTRUMENTS
COLOURING PENS

	Price (€)					
BIC® VISA® Colouring set 1291	500-499	1000-2499	2500-4999	5000-9999	10000-24999	25000-49999
No imprint (bag)	11,17	8,35	6,92	5,89	①	①
SP (bag)	12,04	9,07	7,58	6,54	①	①
OT (bag)	12,97	9,97	8,47	7,43	①	①

BAG: ADDITIONAL IMPRINT CHARGE PER COLOUR & POSITION frais d'impression supplémentaires par couleur et position / cargo por impresión adicional por color y posición / zusätzliche druckkosten pro farbe & position / costo marchio aggiuntivo per colore e posizione

SP	0,87	0,72	0,66	0,65	①	①
OT	1,80	1,62	1,55	1,54	①	①

BIC® Colouring Pens sets are made up of a personalised box, a coloring book and a cotton drawstring bag with BIC® logo. Prices include full colour personalisation on the box and the coloring book. Imprint on the bag is optional. Prices above vary according to the personalisation technique chosen for the bag. Les sets de coloriage BIC® Colouring sont composés d'une boîte de crayons de couleur, d'un cahier de coloriage et d'un sac en coton à cordon coulissant portant le logo BIC®. Le prix inclut la personnalisation complète de la boîte à crayons et du cahier de coloriage. L'impression sur le sac est en option. Les prix ci-dessus varient en fonction de la technique de personnalisation choisie pour le sac / Los sets BIC® Colouring Pens están compuestos por una caja personalizada, un libro para colorear y una bolsa de algodón con el logo BIC®, Los precios incluyen la personalización a todo color en la caja y en el libro para colorear. La impresión en la bolsa es opcional. Los precios anteriores varían según la técnica de personalización elegida para la bolsa / BIC® Mal-Sets bestehen aus einer Schachtel, einem Malbuch und einem Kordelzugbeutel aus Baumwolle mit BIC®-Logo. Die Preise beinhalten einen Digitaldruck auf der Schachtel und auf dem Malbuch. Aufdruck auf dem Beutel nach Wunsch. Die oben angegebenen Preise können je nach für den Beutel gewählter Personalisierungstechnik variieren / I set di penne per colorare BIC® comprendono una custodia personalizzata, un quaderno per colorare e una borsa in cotone con chiusura a cordoncino e logo BIC® impresso. I prezzi comprendono la personalizzazione a colori sulla scatola e sul quaderno per colorare. La stampa sulla borsa è opzionale. I suddetti prezzi possono variare in base alla tecnica di personalizzazione scelta per la borsa.

① Price under request. Prix sur demande. Precio bajo consulta. Preis auf Anfrage. Prezzi su richiesta.

External packaging:

Emballage externe / Envasado exterior / Außenverpackung / Imballaggio esterno



100 ± 10 Kg



BIC® evolution®
Ecolutions®
colouring set
1293



BOX
C DG: 4-colour process

Bag

No imprint (bag)
A SP (bag): max 2 col.
B OT (bag): full-colour

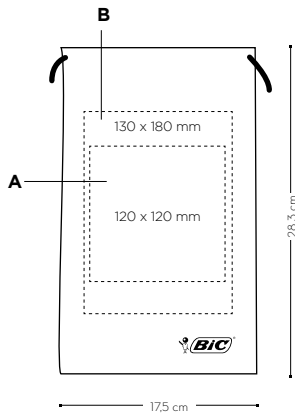

Book

C DG: 4-colour process

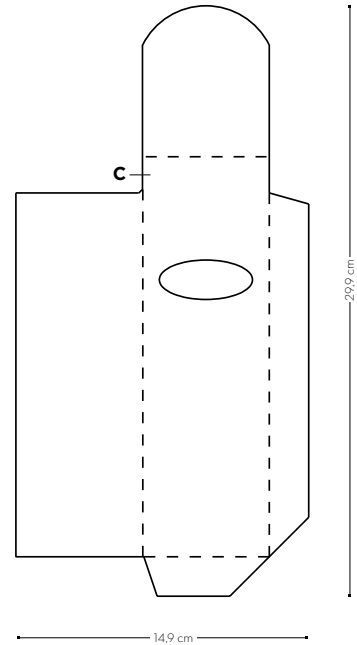
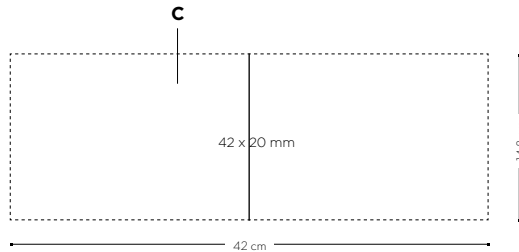

Price (€)

BIC® evolution® ecolutions®
colouring set 1293

	500-4441	1000-2441	2500-4441	5000-4441	10000-2441	25000-4441
No imprint (bag)	9,98	7,19	5,75	4,83	Ⓢ	Ⓢ
SP (bag)	10,85	7,91	6,41	5,48	Ⓢ	Ⓢ
OT (bag)	11,78	8,81	7,30	6,37	Ⓢ	Ⓢ

BAG: ADDITIONAL IMPRINT CHARGE PER COLOUR & POSITION frais d'impression supplémentaires par couleur et position / cargo por impresión adicional por color y posición / zusätzliche druckkosten pro farbe & position / costo marchio aggiuntivo per colore e posizione

SP	0,87	0,72	0,66	0,65	Ⓢ	Ⓢ
OT	1,80	1,62	1,55	1,54	Ⓢ	Ⓢ

BIC® Colouring Pens sets are made up of a personalised box, a coloring book and a cotton drawstring bag with BIC® logo. Prices include full colour personalisation on the box and the coloring book. Imprint on the bag is optional. Prices above vary according to the personalisation technique chosen for the bag. Les sets de coloriage BIC® Colouring sont composés d'une boîte de crayons de couleur, d'un cahier de coloriage et d'un sac en coton à cordon coulissant portant le logo BIC®. Le prix inclut la personnalisation complète de la boîte à crayons et du cahier de coloriage. L'impression sur le sac est en option. Les prix ci-dessus varient en fonction de la technique de personnalisation choisie pour le sac / Los sets BIC® Colouring Pens están compuestos por una caja personalizada, un libro para colorear y una bolsa de algodón con el logo BIC®, Los precios incluyen la personalización a todo color en la caja y en el libro para colorear. La impresión en la bolsa es opcional. Los precios anteriores varían según la técnica de personalización elegida para la bolsa / BIC® Mal-Sets bestehen aus einer Schachtel, einem Malbuch und einem Kordelzugbeutel aus Baumwolle mit BIC®-Logo. Die Preise beinhalten einen Digitaldruck auf der Schachtel und auf dem Malbuch. Aufdruck auf dem Beutel nach Wunsch. Die oben angegebenen Preise können je nach für den Beutel gewählter Personalisierungstechnik variieren / I set di penne per colorare BIC® comprendono una custodia personalizzata, un quaderno per colorare e una borsa in cotone con chiusura a cordoncino e logo BIC® impresso. I prezzi comprendono la personalizzazione a colori sulla scatola e sul quaderno per colorare. La stampa sulla borsa è opzionale. I suddetti prezzi possono variare in base alla tecnica di personalizzazione scelta per la borsa.

Ⓢ Price under request. Prix sur demande. Precio bajo consulta. Preis auf Anfrage. Prezzi su richiesta.

External packaging:

Emballage externe / Envasado exterior /
Außenverpackung / Imballaggio esterno



100 ± 10,6 Kg





by  colouring set



BIC® WRITING INSTRUMENTS

COLOURING PENS



Writing modes:

Mode écriture / Modos de escritura / Schreibmodi / Modalità di scrittura



Printing techniques:

Techniques d'impression / Técnicas de impresión / Drucktechniken / Tecniche di stampa



(SP) SCREEN PRINTING



(OT) OFFSET TRANSFER

External packaging:

Emballage externe / Envasado exterior / Außenverpackung / Imballaggio esterno



100 ± 10,5 Kg



MOQ 500v.

Decoration:

Personalisation / Personalización /
Dekoration / Decorazione

Conté® by BIC® colouring set
1292



BOX

C DG: 4-colour process

Bag

No imprint (bag)

A SP (bag): max 2 col.

B OT (bag): full-colour

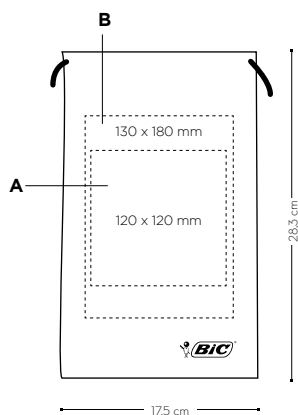

Book

C DG: 4-colour process

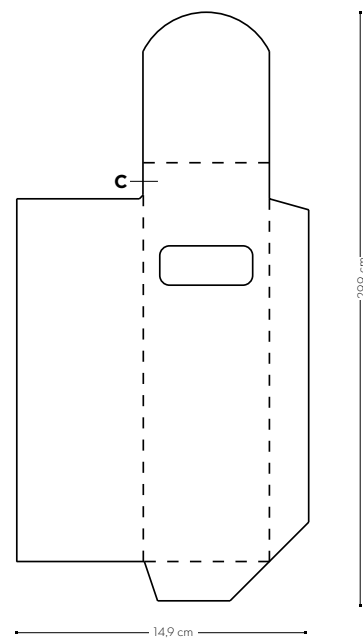
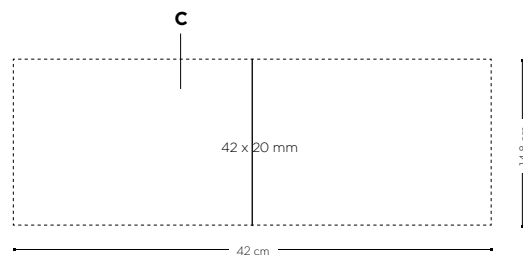

COLOURING PENS
BIC® WRITING INSTRUMENTS

	Price (€)					
Conté® by BIC® colouring set 1292	500-499	1000-2499	2500-4999	5000-9999	10000-24999	25000-49999
No imprint (bag)	10,35	7,55	6,15	5,14	①	①
SP (bag)	11,22	8,27	6,81	5,79	①	①
OT (bag)	12,15	9,17	7,70	6,68	①	①

BAG: ADDITIONAL IMPRINT CHARGE PER COLOUR & POSITION frais d'impression supplémentaires par couleur et position / cargo por impresión adicional por color y posición / zusätzliche druckkosten pro farbe & position / costo marchio aggiuntivo per colore e posizione

SP	0,87	0,72	0,66	0,65	①	①
OT	1,80	1,62	1,55	1,54	①	①

BIC® Colouring Pens sets are made up of a personalised box, a coloring book and a cotton drawstring bag with BIC® logo. Prices include full colour personalisation on the box and the coloring book. Imprint on the bag is optional. Prices above vary according to the personalisation technique chosen for the bag. Les sets de coloriage BIC® Colouring sont composés d'une boîte de crayons de couleur, d'un cahier de coloriage et d'un sac en coton à cordon coulissant portant le logo BIC®. Le prix inclut la personnalisation complète de la boîte à crayons et du cahier de coloriage. L'impression sur le sac est en option. Les prix ci-dessus varient en fonction de la technique de personnalisation choisie pour le sac / Los sets BIC® Colouring Pens están compuestos por una caja personalizada, un libro para colorear y una bolsa de algodón con el logo BIC®. Los precios incluyen la personalización a todo color en la caja y en el libro para colorear. La impresión en la bolsa es opcional. Los precios anteriores varían según la técnica de personalización elegida para la bolsa / BIC® Mal-Sets bestehen aus einer Schachtel, einem Malbuch und einem Kordelzugbeutel aus Baumwolle mit BIC®-Logo. Die Preise beinhalten einen Digitaldruck auf der Schachtel und auf dem Malbuch. Aufdruck auf dem Beutel nach Wunsch. Die oben angegebenen Preise können je nach für den Beutel gewählter Personalisierungstechnik variieren / I set di penne per colorare BIC® comprendono una custodia personalizzata, un quaderno per colorare e una borsa in cotone con chiusura a cordoncino e logo BIC® impresso. I prezzi comprendono la personalizzazione a colori sulla scatola e sul quaderno per colorare. La stampa sulla borsa è opzionale. I suddetti prezzi possono variare in base alla tecnica di personalizzazione scelta per la borsa.

① Price under request. Prix sur demande. Precio bajo consulta. Preis auf Anfrage. Prezzi su richiesta.



Tipp-Ex® Mini Pocket Mouse **britePix™**

The worldwide recognised correction tape Tipp-Ex® in its compact size, that provides an accurate application for both left and right-handed users with literally no dry time!

FR > Les BIC® Sticky Notes : le matériel de bureau indispensable. Faites votre choix parmi une multitude de tailles et de formes. Version Ecolutions® également disponible.

ES > Las BIC® Sticky Notes son una herramienta indispensable en cualquier oficina. Elige entre gran variedad de tamaños y formas. También disponibles en versión Ecolutions®.

DE > Die Haftnotizen BIC® Sticky Notes sind in jedem Büro unverzichtbar. Wählen Sie aus einer großen Auswahl Größen und Formen. Version Ecolutions® ebenfalls erhältlich

IT > BIC® Sticky Notes è uno strumento indispensabile in qualsiasi ufficio. Scegli tra una vasta gamma di dimensioni e forme. Disponibile anche in versione Ecolutions®





1354



51



51

MOQ 250v.

Decoration:

Personalisation / Personalización / Dekoration / Decorazione

Mini Pocket Mouse

1354

A BP: full-colour

BP Texture: full-colour

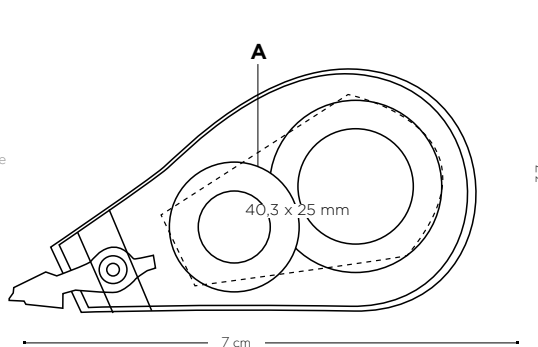

Price (€)

Tip-Ex® Mini Pocket Mouse	250-499	500-999	1000-2499	2500-4999	5000-9999	10000-24999	25000-49999
1354							
BP	1,86	1,76	1,66	1,57	1,47	①	①
ADDITIONAL CHARGES: coûts supplémentaires: / cargos adicionales: / aufpreise: / costi aggiuntivi:							
BP	0,70	0,64	0,59	0,56	0,54	①	①
BP Texture	0,53	0,48	0,44	0,42	0,41	①	①

Prices include one imprint in one position according to specified technique. Les prix incluent une impression sur un emplacement avec la technique spécifiée / Los precios incluyen una impresión en una posición acorde con la técnica especificada / In den Preisen inbegriffen ist ein Aufdruck auf einer Position gemäß angegebener Technik / I prezzi includono una stampa in una posizione a seconda della tecnica specificata.

① Price under request. Prix sur demande. Precio bajo consulta. Preis auf Anfrage. Prezzi su richiesta.

Writing modes:

Mode écriture / Modos de escritura / Schreibmodi / Modalità di scrittura



T
6m

Printing techniques:

Techniques d'impression / Técnicas de impresión / Drucktechniken / Tecniche di stampa



(BP) britePix™



External packaging:

Emballage externe / Envasado exterior / Außenverpackung / Imballaggio esterno



288 ± 3,2 Kg

Check out the video

Regardez la vidéo / Mira el vídeo / Produktvideo / Guarda il video



*Source: GFK panel - Western Europe 9 - MAT June 2018 - Sales in Value & Volume



Other Writing Instruments

BIC® has approved these other writing instruments according the quality and safety standards.

FR > BIC® a approuvé ces autres instruments d'écriture conformément aux normes de qualité et de sécurité.

ES > BIC® ha aprobado otros insrtumentos de escritura acorde con los estandards la calidad y la seguridad

DE > BIC® hat weitere Schreibgeräte gemäß den Qualitäts- und Sicherheitsstandards genehmigt.

IT > BIC® ha approvato questi altri strumenti di scrittura in base agli standard di qualità e sicurezza.



PLASTIC PENS
OTHER WRITING INSTRUMENTS



Basic pen

12010

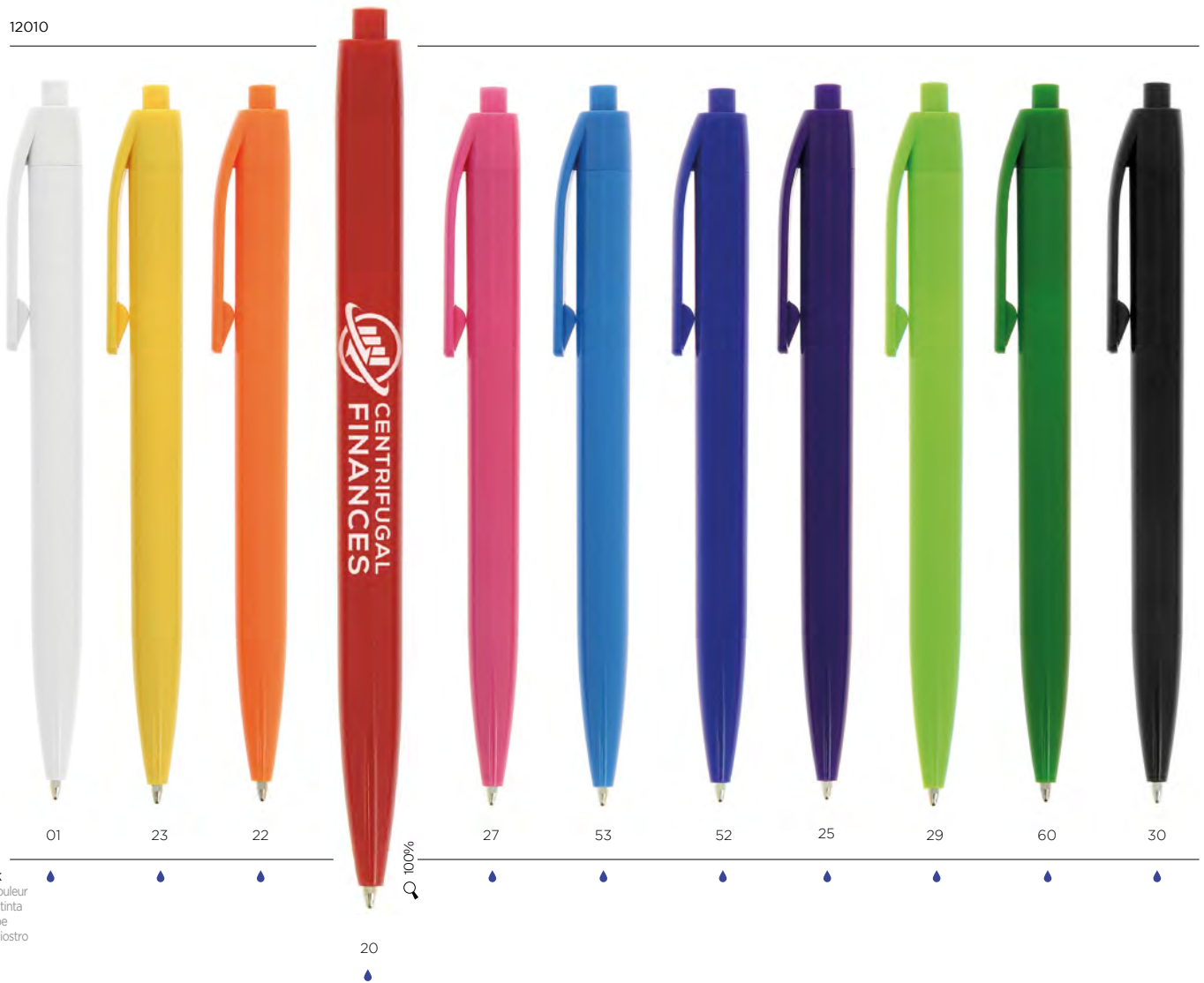

MOA 500v.

Decoration:

Personnalisation / Personalización /
 Dekoration / Decorazione

Basic pen

12010

A/B SP: max. 1 col.

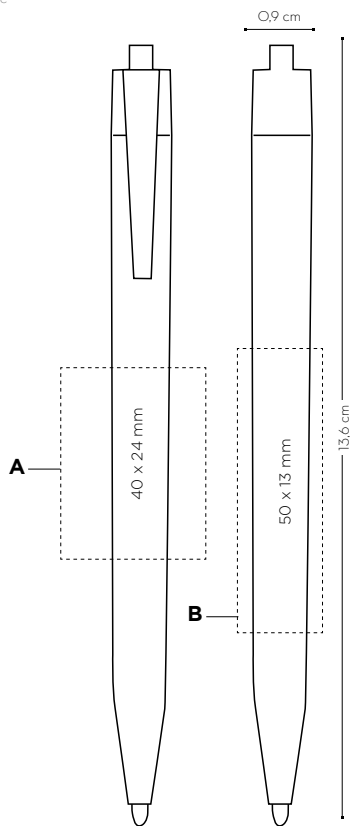

	Price (€)					
Basic pen	500-499	1000-2499	2500-4999	5000-9999	10000-24999	25000-49999
12010						
SP	0,47	0,37	0,31	0,28	①	①

Prices include 1 colour screenprint in one position. Les prix incluent la sérigraphie 1 couleur sur un emplacement. En precio incluye un color en serigrafía en una posición. In den Preisen inbegriffen ist 1 Siebdruck-Farbaufdruck auf 1 Position. I prezzi includono 1 colore a serigrafia in una posizione.

① Price under request. Prix sur demande. Precio bajo consulta. Preis auf Anfrage. Prezzi su richiesta.

Writing modes:

Mode écriture / Modos de escritura /
 Schreibmodi / Modalità di scrittura

Ballpen



M

Printing techniques:

Techniques d'impression / Técnicas de impresión /
 Drucktechniken / Tecniche di stampa



(SP) SCREEN
 PRINTING

External packaging:

Emballage externe / Envasado exterior /
 Außenverpackung / Imballaggio esterno



1000 ± 12,5 Kg



Click pen

11748

OTHER WRITING INSTRUMENTS

PLASTIC PENS



Colour ink
 Encre de couleur
 Color de la tinta
 Schreibfarbe
 Colore inchiostro

100%

White stock lasts Jusqu'à épuisement de stock / Hasta fin de existencias / Solange Vorrat reicht / Fino a esaurimento scorte



MOQ 500v.

Decoration:

Personnalisation / Personalización /
 Dekoration / Decorazione

Click pen

11748

A/B SP: max. 4 col.

C/D PD: max. 4 col.

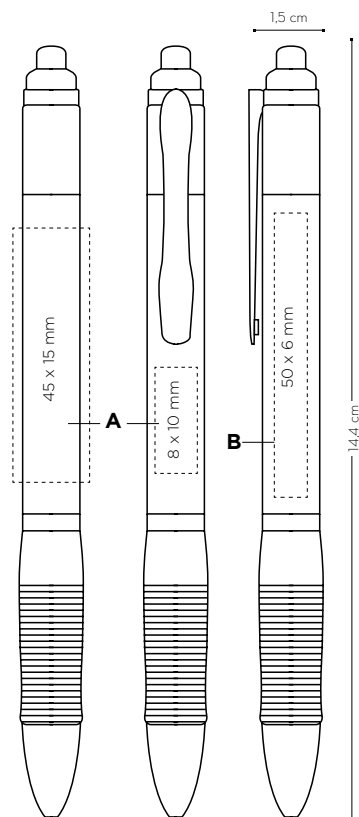

	Price (€)					
Click pen	500-999	1000-2499	2500-4999	5000-9999	10000-24999	25000-49999
11748						
SP	0,51	0,41	0,35	0,32	①	①
PD	0,58	0,49	0,42	0,39	①	①

ADDITIONAL CHARGES: coûts supplémentaires: / cargos adicionales: / aufpreise: / costi aggiuntivi:

SP	0,13	0,13	0,13	0,12	①	①
PD	0,33	0,25	0,18	0,17	①	①

Prices include one imprint in one position according to specified technique. Les prix incluent une impression sur un emplacement avec la technique spécifiée / Los precios incluyen una impresión en una posición acorde con la técnica especificada / In den Preisen inbegriffen ist ein Aufdruck auf einer Position gemäß angegebener Technik / I prezzi includono una stampa in una posizione a seconda della tecnica specificata.

① Price under request. Prix sur demande. Precio bajo consulta. Preis auf Anfrage. Prezzi su richiesta.

Writing modes:

Mode écriture / Modos de escritura /
 Schreibmodi / Modalità di scrittura

Ballpen



M

Printing techniques:

Techniques d'impression / Técnicas de impresión /
 Drucktechniken / Tecniche di stampa



(SP) SCREEN
 PRINTING



(PD) PAD
 PRINTING

External packaging:

Emballage externe / Envasado exterior /
 Außenverpackung / Imballaggio esterno



1000 ± 9,5 Kg



Striped Grip pen

11243



22

20

27

25

51

50

100%

29

60

Colour ink
Encre de couleur
Color de la tinta
Schreibfarbe
Colore inchiostro

OTHER WRITING INSTRUMENTS

PLASTIC PENS



MOA 500v.

Decoration:

Personalisation / Personalización /
 Dekoration / Decorazione

Striped Grip pen

11243

A SP: max. 2 col.

B PD: max. 1 col.

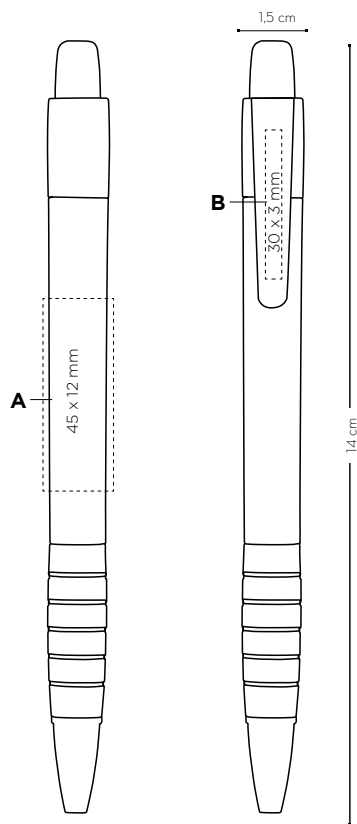

Price (€)

Striped Grip pen

	500-999	1000-2499	2500-4999	5000-9999	10000-24999	25000-49999
11243						
SP	0,61	0,51	0,45	0,41	①	①
PD	0,68	0,59	0,52	0,48	①	①

ADDITIONAL CHARGES: coûts supplémentaires: / cargos adicionales: / aufpreise: / costi aggiuntivi:

SP	0,13	0,13	0,13	0,12	①	①
PD	0,40	0,32	0,25	0,23	①	①

Prices include 1 colour screenprint in one position. Les prix incluent la sérigraphie 1 couleur sur un emplacement. En precio incluye un color en serigrafía en una posición. In den Preisen inbegriffen ist 1 Siebdruck-Farbaufdruck auf 1 Position. I prezzi includono 1 colore a serigrafia in una posizione.

① Price under request. Prix sur demande. Precio bajo consulta. Preis auf Anfrage. Prezzi su richiesta.

Writing modes:

Mode écriture / Modos de escritura /
 Schreibmodi / Modalità di scrittura

Ballpen



M

Printing techniques:

Techniques d'impression / Técnicas de impresión /
 Drucktechniken / Tecniche di stampa



(SP) SCREEN
 PRINTING



(PD) PAD
 PRINTING

External packaging:

Emballage externe / Envasado exterior /
 Außenverpackung / Imballaggio esterno



1000 ± 9 Kg



White striped Grip pen

OTHER WRITING INSTRUMENTS

PLASTIC PENS

11303



20



27



50



25



29



30

Colour ink
Encre de couleur
Color de la tinta
Schreibfarbe
Colore inchiostro

100%



MOQ 500v.

Decoration:

Personnalisation / Personalización /
 Dekoration / Decorazione

White striped Grip pen

11303

A SP: max. 2 col.

B PD: max. 1 col.

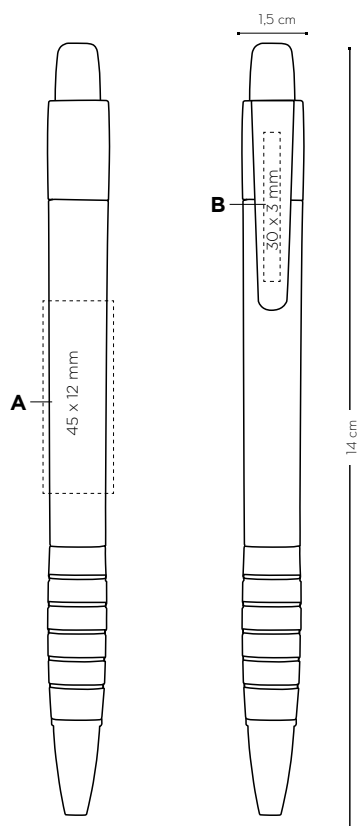

Price (€)

White striped Grip pen	500-999	1000-2499	2500-4999	5000-9999	10000-24999	25000-49999
11303						
SP	0,61	0,51	0,45	0,41	①	①
PD	0,68	0,59	0,52	0,48	①	①

ADDITIONAL CHARGES: coûts supplémentaires: / cargos adicionales: / aufpreise: / costi aggiuntivi:

SP	0,13	0,13	0,13	0,12	①	①
PD	0,40	0,32	0,25	0,23	①	①

Prices include 1 colour screenprint in one position. Les prix incluent la sérigraphie 1 couleur sur un emplacement. En precio incluye un color en serigrafía en una posición. In den Preisen inbegriffen ist 1 Siebdruck-Farbaufdruck auf 1 Position. I prezzi includono 1 colore a serigrafia in una posizione.

① Price under request. Prix sur demande. Precio bajo consulta. Preis auf Anfrage. Prezzi su richiesta.

Writing modes:

Mode écriture / Modos de escritura /
 Schreibmodi / Modalità di scrittura

Ballpen



M

Printing techniques:

Techniques d'impression / Técnicas de impresión /
 Drucktechniken / Tecniche di stampa



(SP) SCREEN
 PRINTING



(PD) PAD
 PRINTING

External packaging:

Emballage externe / Envasado exterior /
 Außenverpackung / Imballaggio esterno



1000 ± 9 Kg



Sleek stylus pen

Sleek stylus pen

11666



Colour ink
Encre de couleur
Color de la tinta
Schreibfarbe
Colore inchiostro

Sleek stylus Matt pen

11747



Sleek stylus Executive pen

11976



OTHER WRITING INSTRUMENTS

STYLUS PENS



MOQ 100v. (LE)
 MOQ 500v. (SP)

Decoration:

Personnalisation / Personalización /
 Dekoration / Decorazione

Sleek stylus pen
 11666

Sleek stylus matt pen
 11747

Sleek stylus executive pen
 11976

A SP: max. 1 col.

B SP: max. 2 col.

C/D/E/F LE

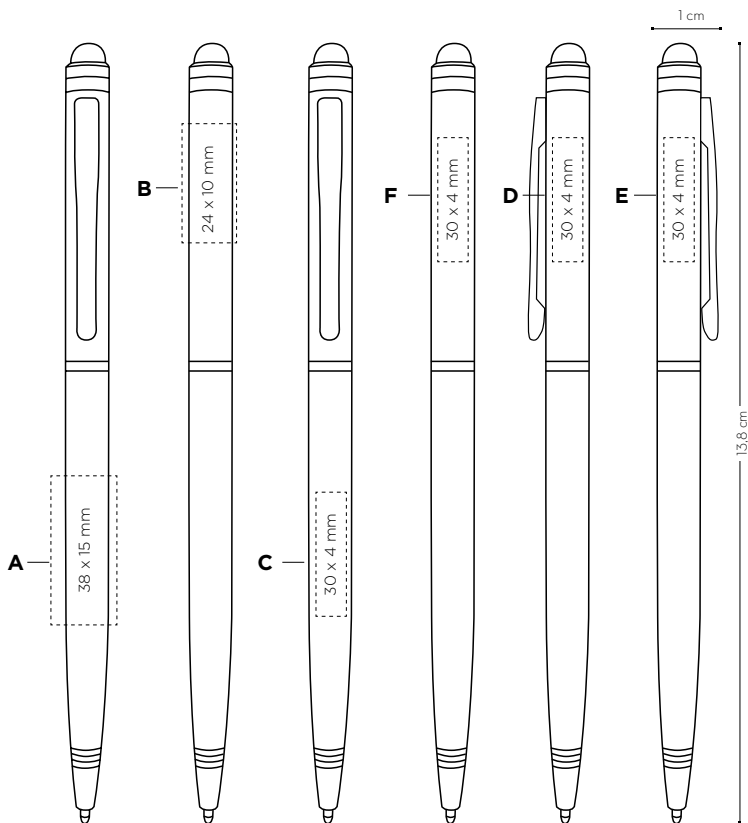

	Price (€)						
	100-249	300-499	500-999	1000-2499	2500-4999	5000-9999	10000-24999
Sleek stylus pen							
11666							
SP	-	2,19	2,01	1,85	1,79	①	①
LE	3,39	2,87	2,63	2,48	2,45	①	①
11747							
SP	-	2,30	2,11	1,94	1,88	①	①
LE	3,50	2,98	2,73	2,57	2,54	①	①
11976							
SP	-	2,32	2,13	1,96	1,90	①	①
LE	3,52	3,00	2,75	2,59	2,56	①	①

ADDITIONAL CHARGES: coûts supplémentaires: / cargos adicionales: / aufpreise: / costi aggiuntivi:

SP	-	0,35	0,30	0,21	0,21	①	①
LE	1,73	1,28	1,10	1,01	0,98	①	①

Prices include 1 colour screenprint in one position. Les prix incluent la sérigraphie 1 couleur sur un emplacement. En precio incluye un color en serigrafía en una posición. In den Preisen inbegriffen ist 1 Siebdruck-Farbaufdruck auf 1 Position. I prezzi includono 1 colore a serigrafia in una posizione.

① Price under request. Prix sur demande. Precio bajo consulta. Preis auf Anfrage. Prezzi su richiesta.

Writing modes:

Mode écriture / Modos de escritura /
 Schreibmodi / Modalità di scrittura

Ballpen



M

Printing techniques:

Techniques d'impression / Técnicas de impresión /
 Drucktechniken / Tecniche di stampa



(SP) SCREEN PRINTING



(LE) LASER

External packaging:

Emballage externe / Envasado exterior /
 Außenverpackung / Imballaggio esterno



11666

900 ± 12,4 Kg



11747
 11976

800 ± 13 Kg

Laser engraving not available in yellow/silver colour
 Gravure laser non disponible en couleur jaune / argent - Grabado láser no disponible en color amarillo y plata - Lasergravur nicht auf Kugelschreiber in gelb und silber erhältlich - Incisione laser non disponibile per il colore giallo/argento



ADHESIVE NOTES

- 208** BIC® 50 mm x 75 mm Adhesive Notepads
- 210** BIC® 68 mm x 75 mm Adhesive Notepads
- 212** BIC® 75 mm x 75 mm Adhesive Notepads
- 216** BIC® 101 mm x 75 mm Adhesive Notepads & Alternating Sheet Imprint
- 220** BIC® 101 mm x 101 mm Adhesive Notepads
- 222** BIC® 101 mm x 152 mm Adhesive Notepads
- 218** BIC® Medium Adhesive Die Cut Notepads
- 214** BIC® Small Adhesive Die Cut Notepads

BOOKLETS

- 228** BIC® 75 x 75 Adhesive Notepad with Flag Booklet
- 232** BIC® 75 x 75 Booklet
- 230** BIC® 101 x 75 Booklet
- 238** BIC® 150 x 150 mm Booklet Organiser
- 240** BIC® 150 x 150 mm Booklet with Pen Loop
- 234** BIC® Clic Stic Mini Organiser & BIC® Clic Stic Mini Digital Organiser
- 226** BIC® Flag Booklet

SCRATCH PADS

- 244** BIC® 75 x 127 mm Non-Adhesive Scratch Pad
- 245** BIC® 96 x 152 mm Non-Adhesive Scratch Pad





 **BiC**® sticky Notes



Sticky Notes

BIC® Sticky Notes, an indispensable tool in any office. Choose between a wide range of sizes and forms. Also Ecolutions® version available

FR > Les BIC® Sticky Notes : le matériel de bureau indispensable. Faites votre choix parmi une multitude de tailles et de formes. Version Ecolutions® également disponible.

ES > Las BIC® Sticky Notes son una herramienta indispensable en cualquier oficina. Elige entre gran variedad de tamaños y formas. También disponibles en versión Ecolutions®.

DE > Die Haftnotizen BIC® Sticky Notes sind in jedem Büro unverzichtbar. Wählen Sie aus einer großen Auswahl Größen und Formen. Version Ecolutions® ebenfalls erhältlich

IT > BIC® Sticky Notes è uno strumento indispensabile in qualsiasi ufficio. Scegli tra una vasta gamma di dimensioni e forme. Disponibile anche in versione Ecolutions®



BIC® STICKY NOTES
ADHESIVE NOTEPADS





ADHESIVE NOTEPADS

BIC® STICKY NOTES



BIC 50 mm x 75 mm Adhesive Notepads
 eco**lutions**® Version Available 

BIC STICKY NOTES
 ADHESIVE NOTEPADS



Ideal pocket size
 for mailing campaigns!

FR > Taille de poche idéale pour les notes d'entreprise!

ES > ¡Tamaño de bolsillo ideal para notas de empresa!

DE > Ideales Taschenformat für Mailingkampagnen!

IT > Dimensioni tascabili ideali per appunti di lavoro!

Exact colour match:

Correspondance exacte des couleurs / Color exacto / Exakte Farbübereinstimmung / Esatta corrispondenza di colore

≥ 500 units

Paper type:

Type de papier / tipo de papel / Papierart / Tipo carta

- Standard 80g
- Recycled 80g

Optional Packaging:

Emballage en option / Envasado opcional / Verpackung auf Wunsch / Imballaggio opzionale

shrink-wrapped

N° Sheets	Units per pack
25	10
50	5
100	1

Printing techniques:

Techniques d'impression / Técnicas de impresión / Drucktechniken / Tecniche di stampa



(DG) DIGITAL



MADE IN SPAIN



Decoration:

Personalisation / Personalización /
Dekoration / Decorazione

BIC® 50 mm x 75 mm MOA 500v.
Adhesive Notepads

A DG: 4-colour process

25  3522
@CColutions® 3520

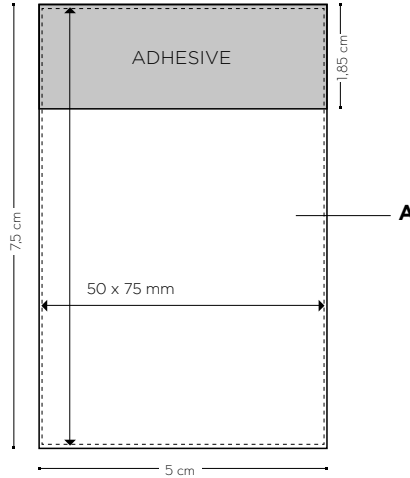

50  3552
@CColutions® 3550

100  3582
@CColutions® 3580



Price (€)

BIC® 50 mm x 75 mm
Adhesive Notepads

	500-499	1000-2499	2500-4999	5000-9999	10000-24999	25000-49999
25  3522						
DG	0,47	0,39	0,26	0,22	0,22	0,22
@CColutions® 3520						
DG	0,53	0,44	0,30	0,25	Ⓢ	Ⓢ
50  3552						
DG	0,78	0,59	0,39	0,33	0,32	0,31
@CColutions® 3550						
DG	0,88	0,67	0,43	0,37	Ⓢ	Ⓢ
100  3582						
DG	1,17	0,96	0,70	0,54	0,53	0,52
@CColutions® 3580						
DG	1,30	1,07	0,77	0,60	Ⓢ	Ⓢ

ADDITIONAL CHARGES Coûts supplémentaires / cargos adicionales / aufpreise / costi aggiuntivi

Exact colour match on pad Tampographie avec correspondance exacte des couleurs / Color exacto en el bloc / Genaue Farbübereinstimmung beim Block / Esatta corrispondenza di colore su tampone 105€

Prices include 4-colour process imprint. Les prix incluent l'impression en quadrichromie. Los precios incluyen una impresión en cuatricromía. In den Preisen inbegriffen ist der Vierfarbdruck-Aufdruck. I prezzi includono la stampa con processo in quadricromia.

Orders must be multiples of the minimum order quantity. Les commandes doivent être un multiple de la quantité minimum indiquée. Los pedidos deben ser múltiples de la cantidad mínima de pedido. Bestellungen müssen das Vielfache der Mindestbestellmenge (500/1000/ etc...). Gli ordini devono essere multipli della quantità minima.



Additional charge for shrink-wrapped pack / Coût additionnelle pour emballage sous film: Coste adicional por el retractilado / Aufpreis für eingeschweißte Einzel- / Mehrverpackung / Supplemento per blister: 0,11€



Ⓢ Price under request. Prix sur demande. Precio bajo consulta. Preis auf Anfrage. Prezzi su richiesta.

External packaging:

Emballage externe / Envasado exterior /
Außenverpackung / Imballaggio esterno

 25 
1000 ± 8,7 Kg

 50 
500 ± 8,5 Kg

 100 
250 ± 8,4 Kg



BIC 68 mm x 75 mm Adhesive Notepads

eco**lutions**® Version Available 



130%

Sticky Notes ideal to always take your messages with you!



BIC® STICKY NOTES
ADHESIVE NOTEPADS

FR > Bloc-notes Sticky Notes idéal pour porter vos messages toujours sur vous !

ES > Bloc de notas Sticky Notes ideal para llevar tus mensajes siempre contigo!

DE > Haftnotizen-Block: Ideal, um Ihre Nachrichten immer bei sich zu tragen!

IT > Blocchetto Sticky Notes ideale per portare i tuoi messaggi sempre con te!

Exact colour match:

Correspondance exacte des couleurs / Color exacto / Exakte Farbübereinstimmung / Esatta corrispondenza di colore

≥ 500 units

Paper type:

Type de papier / tipo de papel / Papierart / Tipo carta

- Standard 80g
- Recycled 80g

Optional Packaging:

Emballage en option / Envasado opcional / Verpackung auf Wunsch / Imballaggio opzionale

shrink-wrapped

N° Sheets	Units per pack
25	10
50	5
100	1

Printing techniques:

Techniques d'impression / Técnicas de impresión / Drucktechniken / Tecniche di stampa



(DG) DIGITAL



MADE IN SPAIN



Decoration:

Personalisation / Personalización /
Dekoration / Decorazione

BIC® 68 mm x 75 mm MOQ 500v.
Adhesive Notepads



A DG: 4-colour process

25  3502
@CColutions® 3500

50  3532
@CColutions® 3530

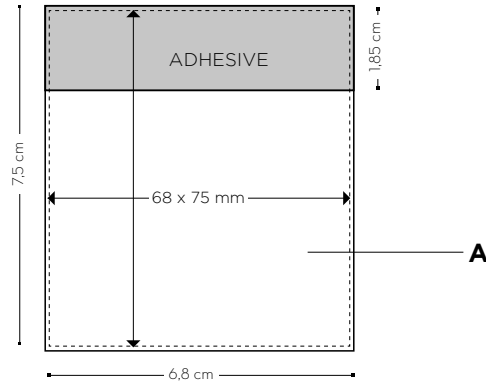
100  3562
@CColutions® 3560



		Price (€)					
		500-999	1000-2499	2500-4999	5000-9999	10000-24999	25000-49999
	3502						
	DG	0,56	0,46	0,30	0,24	0,24	0,24
	@CColutions® 3500						
	DG	0,62	0,51	0,33	0,27	①	①
	3532						
	DG	0,85	0,63	0,46	0,37	0,36	0,35
	@CColutions® 3530						
	DG	0,94	0,69	0,51	0,41	①	①
	3562						
	DG	1,20	1,02	0,80	0,67	0,66	0,65
	@CColutions® 3560						
	DG	1,33	1,13	0,89	0,74	①	①

ADDITIONAL CHARGES Coûts supplémentaires / cargos adicionales / aufpreise / costi aggiuntivi

Exact colour match on pad Tampographie avec correspondance exacte des couleurs / Color exacto en el bloc / Genaue Farbübereinstimmung beim Block / Esatta corrispondenza di colore su tampone 105€

Prices include 4-colour process imprint. Les prix incluent l'impression en quadrichromie. Los precios incluyen una impresión en cuatricromía. In den Preisen inbegriffen ist der Vierfarbdruck-Aufdruck. I prezzi includono la stampa con processo in quadricromia.

Orders must be multiples of the minimum order quantity. Les commandes doivent être un multiple de la quantité minimum indiquée. Los pedidos deben ser múltiples de la cantidad mínima de pedido. Bestellungen müssen das Vielfache der Mindestbestellmenge (500/1000/ etc...). Gli ordini devono essere multipli della quantità minima.

Additional charge for shrink-wrapped pack / Coût additionnelle pour emballage sous film: Coste adicional por el retractilado / Aufpreis für eingeschweißte Einzel- / Mehrverpackung / Supplemento per blister: 0,11€

① Price under request. Prix sur demande. Precio bajo consulta. Preis auf Anfrage. Prezzi su richiesta.

External packaging:

Emballage externe / Envasado exterior /
Außenverpackung / Imballaggio esterno



BIC 75 mm x 75 mm Adhesive Notepads

ecolutions® Version Available 



130%

BIC STICKY NOTES
ADHESIVE NOTEPADS

Large imprint area in a small size!

FR > Grande zone d'impression avec une taille mini!

ES > ¡Gran área de impresión en tamaño pequeño!

DE > Großer Druckbereich, kleines Format!

IT > Vasta area di stampa in piccolo formato!

Exact colour match:

Correspondance exacte des couleurs / Color exacto / Exakte Farbübereinstimmung / Esatta corrispondenza di colore

≥ 500 units

Paper type:

Type de papier / tipo de papel / Papierart / Tipo carta

- Standard 80g
- Recycled 80g

Optional Packaging:

Emballage en option / Envasado opcional / Verpackung auf Wunsch / Imballaggio opzionale

shrink-wrapped

N° Sheets	Units per pack
25	10
50	5
100	1

Printing techniques:

Techniques d'impression / Técnicas de impresión / Drucktechniken / Tecniche di stampa



(DG) DIGITAL



MADE IN SPAIN

*48h only available for 3537
*48h uniquement disponible pour 3537 / *48h solo disponibile para 3547 /
*nur verfügbar für 3537 / Promo 48 H disponibile solo per art 3537



Decoration:

Personalisation / Personalización /
Dekoration / Decorazione

BIC® 75 mm x 75 mm MOQ 500v.
Adhesive Notepads

A DG: 4-colour process

25  3507
@CColutions® 3505

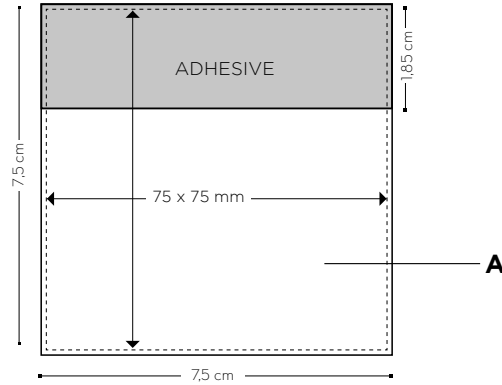

50  3537
@CColutions® 3535

100  3567
@CColutions® 3565



Price (€)

BIC® 75 mm x 75 mm
Adhesive Notepads

	500-499	1000-2499	2500-4999	5000-9999	10000-24999	25000-49999
25  3507						
DG	0,59	0,48	0,33	0,26	0,25	0,25
@CColutions® 3505						
DG	0,65	0,52	0,37	0,29	①	①
50  3537						
DG	0,87	0,65	0,48	0,41	0,40	0,39
@CColutions® 3535						
DG	0,96	0,72	0,53	0,46	①	①
100  3567						
DG	1,24	1,07	0,89	0,83	0,81	0,79
@CColutions® 3565						
DG	1,38	1,19	0,99	0,92	①	①

ADDITIONAL CHARGES Coûts supplémentaires / cargos adicionales / aufpreise / costi aggiuntivi

Exact colour match on pad Tampographie avec correspondance exacte des couleurs / Color exacto en el bloc / Genaue Farbübereinstimmung beim Block / Esatta corrispondenza di colore su tampone 105€

Prices include 4-colour process imprint. Les prix incluent l'impression en quadrichromie. Los precios incluyen una impresión en cuatricromía. In den Preisen inbegriffen ist der Vierfarbdruck-Aufdruck. I prezzi includono la stampa con processo in quadricromia.

Orders must be multiples of the minimum order quantity. Les commandes doivent être un multiple de la quantité minimum indiquée. Los pedidos deben ser múltiples de la cantidad mínima de pedido. Bestellungen müssen das Vielfache der Mindestbestellmenge (500/1000/ etc...). Gli ordini devono essere multipli della quantità minima.

Additional charge for shrink-wrapped pack / Coût additionnelle pour emballage sous film: Coste adicional por el retráctilado / Aufpreis für eingeschweißte Einzel- / Mehrverpackung / Supplemento per blister: 0,11€

① Price under request. Prix sur demande. Precio bajo consulta. Preis auf Anfrage. Prezzi su richiesta.

External packaging:

Emballage externe / Envasado exterior /
Außenverpackung / Imballaggio esterno



Small Adhesive Die Cut Notepads

BIC STICKY NOTES
ADHESIVE NOTEPADS



Choose from 7 stock shapes!
Custom-made shapes available upon request

FR > Choisissez parmi les 7 formes en stock ! Formes spéciales sur demande.

ES > ¡Elija entre 7 formas diferentes! Formas personalizadas disponibles bajo petición.

DE > Wählen Sie eine der 7 Standardformen. Kundenspezifische Formen sind auf Anfrage erhältlich.

IT > Scegli tra le 7 forme disponibili! Forme personalizzate disponibili su richiesta.

Exact colour match:

Correspondance exacte des couleurs / Color exacto / Exakte Farbübereinstimmung / Esatta corrispondenza di colore

≥ 500 units

Paper type:

Type de papier / tipo de papel / Papierart / Tipo carta

Standard 80g

Optional Packaging:

Emballage en option / Envasado opcional / Verpackung auf Wunsch / Imballaggio opzionale

shrink-wrapped

N° Sheets	Units per pack
25	10
50	5
100	1

Printing techniques:

Techniques d'impression / Técnicas de impresión / Drucktechniken / Tecniche di stampa



(DG) DIGITAL



MADE IN SPAIN





Decoration:

Personalisation / Personalización /
Dekoration / Decorazione

BIC® Small Adhesive
Die Cut Notepads



MOQ 500v.

A DG: 4-colour process

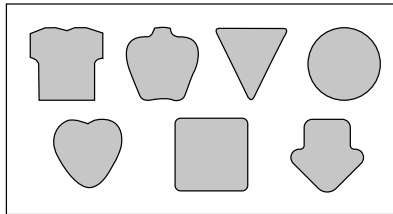
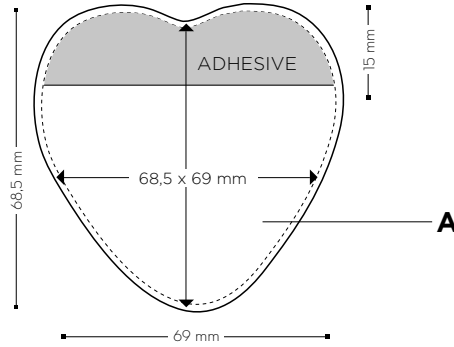
-  25 3603
-  50 3607
-  100 3611



Price (€)

BIC® Small Adhesive Die Cut Notepad		500-999	1000-2499	2500-4999	5000-9999	10000-24999	25000-49999
 25	3603						
	DG	0,97	0,77	0,53	0,43	0,42	0,41
 50	3607						
	DG	1,47	1,10	0,80	0,70	0,69	0,68
 100	3611						
	DG	2,28	1,97	1,64	1,52	1,49	1,46

ADDITIONAL CHARGES Coûts supplémentaires / cargos adicionales / aufpreise / costi aggiuntivi

Exact colour match on pad Tamponographie avec correspondance exacte des couleurs / Color exacto en el bloc / Genaue Farbübereinstimmung beim Block / Esatta corrispondenza di colore su tampone 105€

Custom made shape set up charge (per order &/or shape) Frais d'installation pour forme faite sur mesure (par commande et/ou forme) / Cargo por forma personalizada (por pedido y/o forma) / Einrichtungskosten für kundenindividuelle Form (pro Auftrag und/oder Form) / Costo di set up per forma personalizzata (per ordine e/o forma) 1195€

Repeat order Renouvellement de commande / Para pedidos de repetición / Folgeauftrag / Riassortimento Free

Prices include 4-colour process imprint. Les prix incluent l'impression en quadrichromie. Los precios incluyen una impresión en cuatricromia. In den Preisen inbegriffen ist der Vierfarbdruck-Aufdruck. I prezzi includono la stampa con processo in quadricromia.

Orders must be multiples of the minimum order quantity. Les commandes doivent être un multiple de la quantité minimum indiquée. Los pedidos deben ser múltiples de la cantidad mínima de pedido. Bestellungen müssen das Vielfache der Mindestbestellmenge (500/1000/ etc...). Gli ordini devono essere multipli della quantità minima.

Additional charge for shrink-wrapped pack / Coût additionnelle pour emballage sous film: Coste adicional por el retráctilado / Aufpreis für eingeschweißte Einzel- / Mehrverpackung / Supplemento per blister: 0,11€

External packaging:

Emballage externe / Envasado exterior /
Außenverpackung / Imballaggio esterno





101 mm x 75 mm Adhesive Notepads & BIC® 101 mm x 75 mm Alternating Sheet Imprint



ecolutions® Version Available

Indispensable in any office!
Most popular sticky notes pad size!



100%



Alternate 2 messages for double-impact communication!

FR > Indispensable dans n'importe quel bureau! Le Sticky Notes de la taille la plus populaire!
Alternate 2 messages for double-impact communication!

ES > ¡Indispensable en cualquier oficina! ¡El bloc de notas Sticky Notes del tamaño más popular!
¡Alterna 2 mensajes para obtener un doble impacto!

DE > Unverzichtbar in jedem Büro! Die beliebteste Haftnotizen-Blockgröße!
Mit zwei sich Seite-für-Seite abwechselnden Botschaften erzielen Sie die doppelte Wirkung!

IT > Indispensabile in ogni ufficio! Lo Sticky Notes nel formato più diffuso!
Alterna 2 messaggi per ottenere un doppio impatto!

Exact colour match:

Correspondance exacte des couleurs / Color exacto / Exakte Farbübereinstimmung / Esatta corrispondenza di colore

≥ 500 units

Paper type:

Type de papier / Tipo de papel / Papierart / Tipo carta

- Standard 80g
 Recycled 80g

Optional Packaging:

Emballage en option / Envasado opcional / Verpackung auf Wunsch / Imballaggio opzionale

shrink-wrapped

N° Sheets	Units per pack
25	10
50	5
100	1

Printing techniques:

Techniques d'impression / Técnicas de impresión / Drucktechniken / Tecniche di stampa



(DG) DIGITAL



MADE IN SPAIN

*48h only available for 3542

*48h uniquement disponible pour 3542 / *48h solo disponibile para 3542 /

*nur verfügbar für 3542 / Promo 48 H disponibile solo per art 3542









Decoration:

Personalisation / Personalización /
Dekoration / Decorazione

BIC® 101 MM X 75 MM Adhesive Notepads & Alternating Sheet Imprint

A DG: 4-colour process





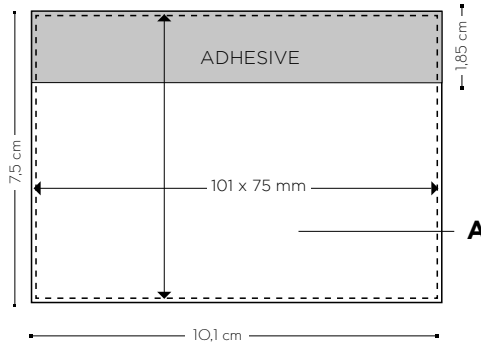

-  25  3510
Alternating Sheet 3514
-  50  3540
Alternating Sheet 3544
-  100  3570

MOQ 500v.

MOQ 250v.

MOQ 500v.



		Price (€)						
		250-499	500-999	1000-2499	2500-4999	5000-9999	10000-24999	25000-49999
	3512							
	DG	-	0,70	0,54	0,41	0,33	0,32	0,31
	 3510							
	DG	-	0,78	0,61	0,46	0,37	①	①
	Alternating Sheet 3514							
	DG	-	0,70	0,54	0,41	0,33	0,32	0,31
	3542							
	DG	1,13	0,96	0,80	0,59	0,52	0,51	0,50
	 3540							
	DG	1,26	1,07	0,89	0,66	0,58	①	①
	Alternating Sheet 3544							
	DG	1,13	0,96	0,80	0,59	0,52	0,51	0,50
	3572							
	DG	-	1,59	1,28	1,11	1,00	0,98	0,96
	 3570							
	DG	-	1,79	1,43	1,25	1,12	①	①

ADDITIONAL CHARGES Coûts supplémentaires / cargos adicionales / aufpreise / costi aggiuntivi

Exact colour match on pad Tampographie avec correspondance exacte des couleurs / Color exacto en el bloc / Genaue Farbübereinstimmung beim Block / Esatta corrispondenza di colore su tampone 105€

Prices include 4-colour process imprint. Les prix incluent l'impression en quadrichromie. Los precios incluyen una impresión en cuatricromía. In den Preisen inbegriffen ist der Vierfarbdruck-Aufdruck. I prezzi includono la stampa con processo in quadricromia.

Orders must be multiples of the minimum order quantity. Les commandes doivent être un multiple de la quantité minimum indiquée. Los pedidos deben ser múltiples de la cantidad mínima de pedido. Bestellungen müssen das Vielfache der Mindestbestellmenge (500/1000/ etc...). Gli ordini devono essere multipli della quantità minima.

Additional charge for shrink-wrapped pack / Coût additionnelle pour emballage sous film: Coste adicional por el retractilado / Aufpreis für eingeschweißte Einzel- / Mehrverpackung / Supplemento per blister: 0,11€

① Price under request. Prix sur demande. Precio bajo consulta. Preis auf Anfrage. Prezzi su richiesta.

External packaging:

Emballage externe / Envasado exterior /
Außenverpackung / Imballaggio esterno

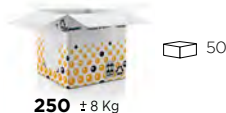



Medium Adhesive Die Cut Notepads

ecolutions® Version Available

BIC STICKY NOTES
ADHESIVE NOTEPADS



125%

Choose from 28 stock shapes!
Custom-made shapes also available upon request

FR > Choisissez parmi les 28 formes en stock ! Formes spéciales sur demande.

ES > ¡Escoge entre 28 formas diferentes! Formas personalizadas también disponibles bajo petición.

DE > Wählen Sie eine der 28 Standardformen. Kundenspezifische Formen sind auf Anfrage erhältlich.

IT > Scegli tra le oltre 28 forme! Forme personalizzate disponibili su richiesta

Exact colour match:

Correspondance exacte des couleurs / Color exacto / Exakte Farbübereinstimmung / Esatta corrispondenza di colore

≥ 500 units

Paper type:

Type de papier / tipo de papel / Papierart / Tipo carta

- Standard 80g
- Recycled 80g

Optional Packaging:

Emballage en option / Envasado opcional / Verpackung auf Wunsch / Imballaggio opzionale

shrink-wrapped

N° Sheets	Units per pack
25	10
50	5
100	1

Printing techniques:

Techniques d'impression / Técnicas de impresión / Drucktechniken / Tecniche di stampa



(DG) DIGITAL



MADE IN SPAIN







Decoration:

Personnalisation / Personalización / Dekoration / Decorazione

BIC® Medium Adhesive Die Cut Notepads





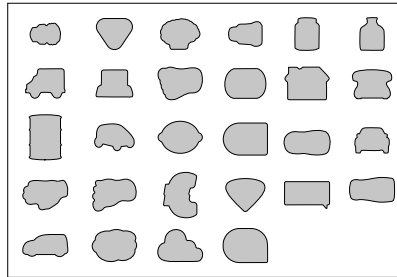
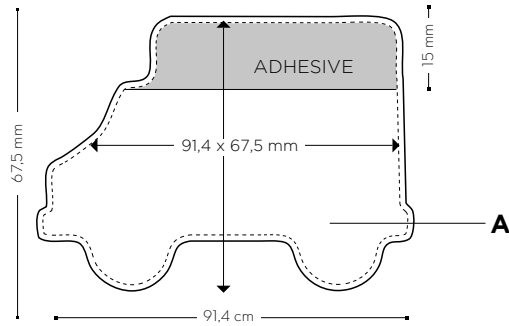

MOQ 500v.

A DG: 4-colour process

- 25  3604  3602
- 50  3608  3606
- 100  3612  3610



Price (€)

	500-499	1000-2499	2500-4999	5000-9999	10000-24999	25000-49999
3604						
 DG	1,07	0,83	0,64	0,50	0,49	0,48
 3602						
DG	1,17	0,91	0,69	0,55	①	①
3608						
 DG	1,84	1,42	1,05	0,90	0,88	0,86
 3606						
DG	1,98	1,54	1,13	0,97	①	①
3612						
 DG	2,79	2,25	1,95	1,76	1,72	1,69
 3610						
DG	3,24	2,60	2,26	2,04	①	①

ADDITIONAL CHARGES Coûts supplémentaires / cargos adicionales / aufpreise / costi aggiuntivi

Exact colour match on pad Tampographie avec correspondance exacte des couleurs / Color exacto en el bloc / Genaue Farbübereinstimmung beim Block / Esatta corrispondenza di colore su tampone 105€

Custom made shape set up charge (per order &/or shape) Frais d'installation pour forme faite sur mesure (par commande et/ou forme) / Cargo por forma personalizada (por pedido y/o forma) / Einrichtungskosten für kundenindividuelle Form (pro Auftrag und/oder Form) / Costo di set up per forma personalizzata (per ordine e/o forma) 1195€

Repeat order Renouvellement de commande / Para pedidos de repetición / Folgeauftrag / Riassortimento Free

Prices include 4-colour process imprint. Les prix incluent l'impression en quadrichromie. Los precios incluyen una impresión en cuatricromía. In den Preisen inbegriffen ist der Vierfarbdruck-Aufdruck. I prezzi includono la stampa con processo in quadricromia.

Orders must be multiples of the minimum order quantity. Les commandes doivent être un multiple de la quantité minimum indiquée. Los pedidos deben ser múltiples de la cantidad mínima de pedido. Bestellungen müssen das Vielfache der Mindestbestellmenge (500/1000/ etc...). Gli ordini devono essere multipli della quantità minima.

Additional charge for shrink-wrapped pack / Coût additionnelle pour emballage sous film: Coste adicional por el retractilado / Aufpreis für eingeschweißte Einzel- / Mehrverpackung / Supplemento per blister: 0,11€

① Price under request. Prix sur demande. Precio bajo consulta. Preis auf Anfrage. Prezzi su richiesta.

External packaging:

Emballage externe / Envasado exterior / Außenverpackung / Imballaggio esterno



BIC 101 mm x 101 mm Adhesive Notepads
 ecolutions® Version Available 

BIC STICKY NOTES
 ADHESIVE NOTEPADS



FR > Profitez de sa large zone d'impression !

ES > ¡Aprovecha la oportunidad con esta gran área de impresión!

DE > Nutzen Sie diesen großen Druckbereich!

IT > Sfrutta quest'ampia area di stampa!

Exact colour match:

Correspondance exacte des couleurs / Color exacto / Exakte Farbübereinstimmung / Esatta corrispondenza di colore

≥ 500 units

Paper type:

Type de papier / tipo de papel / Papierart / Tipo carta

- Standard 80g
- Recycled 80g

Optional Packaging:

Emballage en option / Envasado opcional / Verpackung auf Wunsch / Imballaggio opzionale

shrink-wrapped

N° Sheets	Units per pack
25	10
50	5
100	1

Printing techniques:

Techniques d'impression / Técnicas de impresión / Drucktechniken / Tecniche di stampa



(DG) DIGITAL



MADE IN SPAIN



Decoration:

Personalisation / Personalización /
Dekoration / Decorazione

BIC® 101 mm x 101 mm
Adhesive Notepads

MOQ 500v.

A DG: 4-colour process

25  3518
@ccolutions® 3516

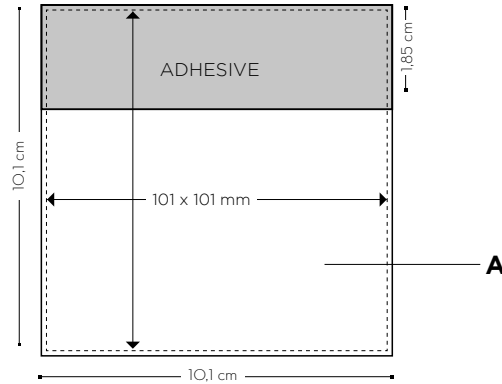

50  3548
@ccolutions® 3546

100  3578
@ccolutions® 3576



Price (€)

BIC® 101 mm x 101 mm
Adhesive Notepads

	500-999	1000-2499	2500-4999	5000-9999	10000-24999	25000-49999
25  3518						
DG	1,00	0,70	0,52	0,43	0,42	0,41
@ccolutions® 3516						
DG	1,10	0,76	0,57	0,47	ⓘ	ⓘ
50  3548						
DG	1,26	1,07	0,85	0,70	0,69	0,68
@ccolutions® 3546						
DG	1,39	1,18	0,94	0,77	ⓘ	ⓘ
100  3578						
DG	2,09	1,78	1,50	1,33	1,30	1,27
@ccolutions® 3576						
DG	2,30	1,96	1,66	1,47	ⓘ	ⓘ

ADDITIONAL CHARGES Coûts supplémentaires / cargos adicionales / aufpreise / costi aggiuntivi

Exact colour match on pad Tampographie avec correspondance exacte des couleurs / Color exacto en el bloc / Genaue Farbübereinstimmung beim Block / Esatta corrispondenza di colore su tampone 105€

Prices include 4-colour process imprint. Les prix incluent l'impression en quadrichromie. Los precios incluyen una impresión en cuatricromía. In den Preisen inbegriffen ist der Vierfarbdruck-Aufdruck. I prezzi includono la stampa con processo in quadricromia.

Orders must be multiples of the minimum order quantity. Les commandes doivent être un multiple de la quantité minimum indiquée. Los pedidos deben ser múltiples de la cantidad mínima de pedido. Bestellungen müssen das Vielfache der Mindestbestellmenge (500/1000/ etc...). Gli ordini devono essere multipli della quantità minima.

Additional charge for shrink-wrapped pack / Coût additionnelle pour emballage sous film: Coste adicional por el retractilado / Aufpreis für eingeschweißte Einzel- / Mehrverpackung / Supplemento per blister: 0,11€

ⓘ Price under request. Prix sur demande. Precio bajo consulta. Preis auf Anfrage. Prezzi su richiesta.

External packaging:

Emballage externe / Envasado exterior /
Außenverpackung / Imballaggio esterno



BIC 101 mm x 152 mm Adhesive Notepads
 ecolutions® Version Available 

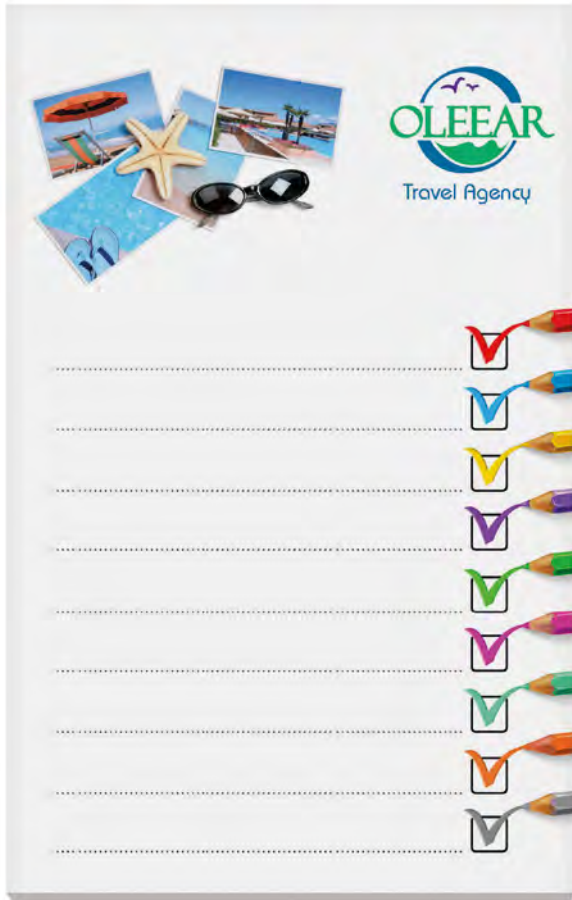

BIC STICKY NOTES
 ADHESIVE NOTEPADS

130%

Large imprint area for big messages!
 Don't miss anything!

FR > Grande surface d'impression pour de grands messages ! Pour que rien ne vous échappe !

ES > ¡Gran área de impresión para grandes mensajes! ¡No te pierdas nada!

DE > Großer Druckbereich für großartige Nachrichten! Vergessen Sie nichts!

IT > Ampia area di stampa per grandi messaggi! Non perderti nulla!

Exact colour match:

Correspondance exacte des couleurs / Color exacto / Exakte Farbübereinstimmung / Esatta corrispondenza di colore

≥ 500 units

Paper type:

Type de papier / Tipo de papel / Papierart / Tipo carta

- Standard 80g
- Recycled 80g

Optional Packaging:

Emballage en option / Envasado opcional / Verpackung auf Wunsch / Imballaggio opzionale

shrink-wrapped

N° Sheets	Units per pack
25	10
50	5
100	1

Printing techniques:

Techniques d'impression / Técnicas de impresión / Drucktechniken / Tecniche di stampa



(DG) DIGITAL



MADE IN SPAIN



Decoration:

Personalisation / Personalización /
Dekoration / Decorazione

BIC® 101 mm x 152 mm
Adhesive Notepads

MOQ 500v.

A DG: 4-colour process

25  3517
@ccolutions® 3515





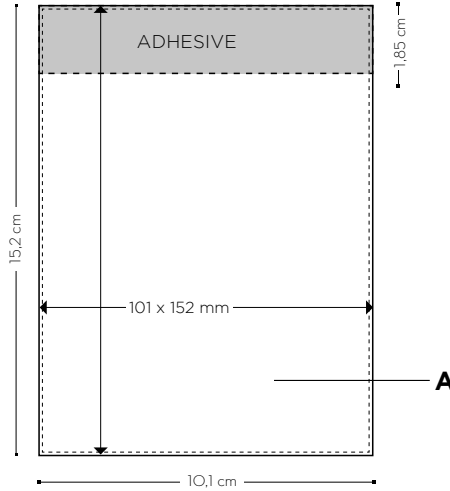

50  3547
@ccolutions® 3545

100  3577
@ccolutions® 3575



Price (€)

BIC® 101 mm x 152 mm
Adhesive Notepads

	500-499	1000-2499	2500-4999	5000-9999	10000-24999	25000-49999
3517						
 25 DG	1.20	1.02	0.76	0.65	0.64	0.63
 25 @ccolutions® 3515						
DG	1.32	1.13	0.84	0.72	①	①
3547						
 50 DG	1.65	1.37	1.20	1.02	1.00	0.98
 50 @ccolutions® 3545						
DG	1.82	1.51	1.33	1.12	①	①
3577						
 100 DG	2.52	2.20	1.89	1.80	1.76	1.72
 100 @ccolutions® 3575						
DG	2.80	2.44	2.09	2.00	①	①

ADDITIONAL CHARGES Coûts supplémentaires / cargos adicionales / aufpreise / costi aggiuntivi

Exact colour match on pad Tampographie avec correspondance exacte des couleurs / Color exacto en el bloc / Genaue Farbübereinstimmung beim Block / Esatta corrispondenza di colore su tampone 105€

Prices include 4-colour process imprint. Les prix incluent l'impression en quadrichromie. Los precios incluyen una impresión en cuatricromia. In den Preisen inbegriffen ist der Vierfarbdruck-Aufdruck. I prezzi includono la stampa con processo in quadricromia.

Orders must be multiples of the minimum order quantity. Les commandes doivent être un multiple de la quantité minimum indiquée. Los pedidos deben ser múltiples de la cantidad mínima de pedido. Bestellungen müssen das Vielfache der Mindestbestellmenge (500/1000/ etc...). Gli ordini devono essere multipli della quantità minima.

Additional charge for shrink-wrapped pack / Coût additionnelle pour emballage sous film: Coste adicional por el retractilado / Aufpreis für eingeschweißte Einzel- / Mehrverpackung / Supplemento per blister: 0,11€

① Price under request. Prix sur demande. Precio bajo consulta. Preis auf Anfrage. Prezzi su richiesta.

External packaging:

Emballage externe / Envasado exterior /
Außenverpackung / Imballaggio esterno

  25
250 ± 8,5 Kg

  50
125 ± 8,2 Kg

  100
65 ± 8,3 Kg





The multi-purpose notes tool! Double the impact of your message with a fully personalised cover and Sticky Notes pad.

FR > Le multifonction pour la prise de notes ! Double impact de votre message grâce à la couverture personnalisée et au bloc-notes Sticky Notes.

ES > ¡El bloc de notas multiuso! Doble impacto para tu mensaje gracias a la cubierta personalizada y a su bloc de notas BIC® Sticky Notes.

DE > Das Multitool für Ihre Notizen! Doppelte Wirkung für Ihre Marke dank vollständig personalisierter Deckseite und Haftnotizenblock.

IT > Il blocchetto multi funzione! Un doppio impatto per il tuo messaggio con la copertina e il blocco Sticky Notes personalizzati.



BOOKLETS
BIC STICKY NOTES





Choose a cover finish for your booklet: brilliant, pattern laminated or matt soft-feel laminated

25 flags of each colour!

FR > Choisissez une finition de couverture pour votre livret: brillant, motif laminé ou feuilleté mat au toucher doux. 25 marque-pages adhésifs de chaque couleur !

ES > Escoge un acabado para la portada de tu booklet: brillante, patrón laminado o laminado mate de tacto suave. 25 flags de cada color!

DE > Wählen Sie ein Cover-Finish für Ihr Booklet: brillant, laminiert oder mattes Soft-Feel. 25 Flags in jeder Farbe!

IT > Scegli una finitura per il tuo booklet: brillante, modello laminato, mate o suave al tatto. 25 segnalibri per ogni colore!

Optional Packaging:

Emballage en option / Envasado opcional / Verpackung auf Wunsch / Imballaggio opzionale

Shrink-wrapped: 10 Booklets

Printing techniques:

Techniques d'impression / Técnicas de impresión / Drucktechniken / Tecniche di stampa



(DG) DIGITAL



MADE IN SPAIN



Decoration:

Personalisation / Personalización /
Dekoration / Decorazione

BIC® Flag Booklet

MOQ 250v.

A/B DG: 4-colour process

 25 3730

 25 Flags per color

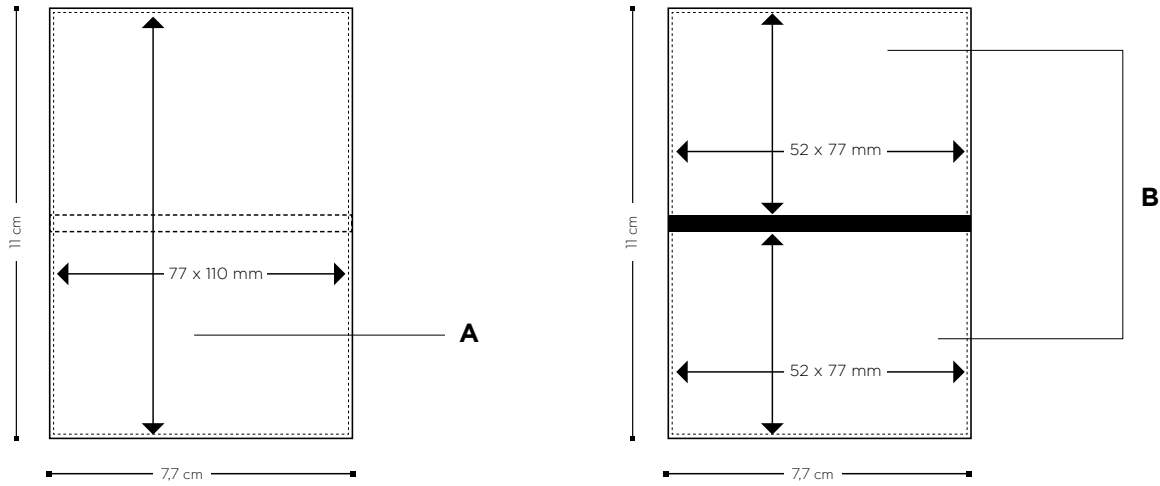

	Price (€)						
BIC® Flag Booklet	250-499	500-999	1000-2499	2500-4999	5000-9999	10000-24999	25000-49999
3730							
DG	2,17	1,81	1,40	0,97	0,83	0,81	0,79

ADDITIONAL CHARGES Coûts supplémentaires / cargos adicionales / aufpreise / costi aggiuntivi

Printing on Inside cover Impression sur la couverture intérieure / Impresión en cubierta interior / Druck auf der Innenseite des Covers / Stampa sull'interno della copertina

0,08 0,07 0,07 0,07 0,06 0,06 0,06

Matt soft-feel/pattern laminated finish Finition laminée mate au toucher doux / Acabado laminado mate soft-feel / Matt-softig laminierte Oberfläche / Finitura plastificata opaca morbida

0,08 0,07 0,07 0,07 0,06 0,06 0,06

Orders must be multiples of the minimum order quantity. Les commandes doivent être un multiple de la quantité minimum indiquée. Los pedidos deben ser múltiples de la cantidad mínima de pedido. Bestellungen müssen das Vielfache der Mindestbestellmenge (500/1000/ etc...). Gli ordini devono essere multipli della quantità minima.

BIC® Booklets: Prices include 4-colour process imprint only on the external part of the cover. Les prix incluent l'impression en quadrichromie seulement sur la couverture extérieure. Los precios incluyen impresión en cuatricromía sólo en el exterior de la cubierta. Preis inklusive Vierfarbdruck nur auf der Außenseite des Covers. I prezzi includono solo il processo di stampa in quadricromia sull'esterno della copertina

Additional charge for shrink-wrapped pack / Coût additionnelle pour emballage sous film / Coste adicional por el retractilado / Aufpreis für eingeschweißte Einzel- / Mehrverpackung / Supplemento per blister: 0,11€

External packaging:

Emballage externe / Envasado exterior /
Außenverpackung / Imballaggio esterno



 25

150 ± 1,56 Kg



100%

FR > Double impact de votre message
DE > Doppelte Wirkung für Ihre Marke

ES > Doble impacto para tu mensaje
IT > Un doppio impatto per il tuo messaggio

Paper type:

Type de papier / tipo de papel /
Papierart / Tipo carta

Standard 80g

Optional Packaging:

Emballage en option / Envasado opcional /
Verpackung auf Wunsch / Imballaggio opzionale

Shrink-wrapped: 10 Booklets

Printing techniques:

Techniques d'impression / Técnicas de impresión /
Drucktechniken / Tecniche di stampa



(DG) DIGITAL



MADE IN
SPAIN

Decoration:



Personalisation / Personalización /
Dekoration / Decorazione

MOQ with unimprinted pad: 2500.



MOQ with imprinted pad: 5000.

BIC® 75 X 75 Booklet

A/B/C/D DG: 4-colour process

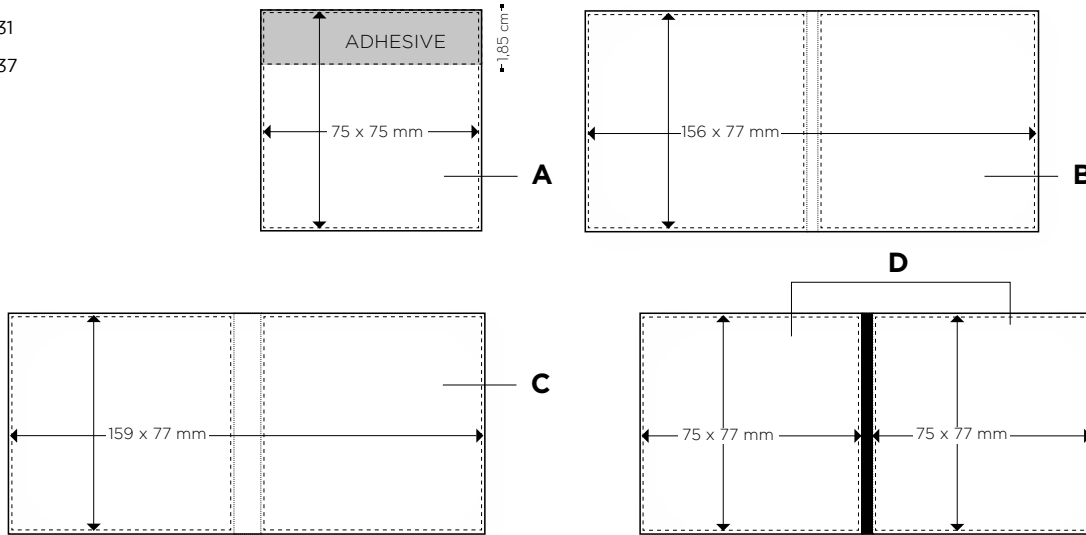
-  25 3731
-  50 3737



		Price (€)							
		BIC® 75 X 75 Booklet	250-499	500-999	1000-2499	2500-4999	5000-9999	10000-24999	25000-49999
	25	3731*							
		DG	1,71	1,42	1,28	1,05	0,96	0,94	0,92
	50	3737							
		DG	2,16	1,79	1,57	1,35	1,24	1,22	1,20

ADDITIONAL CHARGES Coûts supplémentaires / cargos adicionales / aufpreise / costi aggiuntivi

Exact colour match on pad Tampographie avec correspondance exacte des couleurs / Color exacto en el bloc / Genaue Farbübereinstimmung beim Block / Esatta corrispondenza di colore su tampone 105€

Printing on pad Impression sur le bloc / Impresión en el bloc / Druck auf dem Block / Stampa sul blocco
0,08 0,07 0,07 0,07 0,06 0,06 0,06

Printing on inside cover Impression sur la couverture intérieure / Impresión en cubierta interior / Druck auf der Innenseite des Covers / Stampa sull'interno della copertina
0,08 0,07 0,07 0,07 0,06 0,06 0,06

Matte soft-feel/pattern laminated finish Finition laminée mate au toucher doux / Acabado laminado mate soft-feel / Matt-softig laminierte Oberfläche / Finitura plastificata opaca morbida
0,08 0,07 0,07 0,07 0,06 0,06 0,06

Orders must be multiples of the minimum order quantity. Les commandes doivent être un multiple de la quantité minimum indiquée. Los pedidos deben ser múltiplos de la cantidad mínima de pedido. Bestellungen müssen das Vielfache der Mindestbestellmenge (500/1000/ etc...). Gli ordini devono essere multipli della quantità minima.

BIC® Booklets: Prices include 4-colour process imprint only on the external part of the cover. Les prix incluent l'impression en quadrichromie seulement sur la couverture extérieure. Los precios incluyen impresión en cuatricromía sólo en el exterior de la cubierta. Preis inklusive Vierfarbdruck nur auf der Außenseite des Covers. I prezzi includono solo il processo di stampa in quadricromia sull'esterno della copertina

Additional charge for shrink-wrapped pack / Coût additionnelle pour emballage sous film / Coste adicional por el retráctilado / Aufpreis für eingeschweißte Einzel- / Mehrverpackung / Supplemento per blister: 0,11€

* < 500 units only possible with unprinted BIC® Sticky Notes / Commandes inférieures à 500 unités disponibles seulement avec BIC® Sticky Notes sans impression / * Pedidos inferiores a 500 unidades sólo disponibles con BIC® Sticky Notes sin impresión / * < 500 Stück nur mit unbedruckten BIC® Sticky Notes / * < 500 unità possibile solo con BIC® Sticky Notes senza stampa

External packaging:

Emballage externe / Envasado exterior /
Außenverpackung / Imballaggio esterno





Double the impact of your message with a fully personalised cover and sticky notes pad in the most popular size

FR > Double impact de votre message grâce à la couverture personnalisée et au bloc-notes Sticky Notes dans sa taille la plus populaire.

ES > Doble impacto para tu mensaje gracias a su cubierta personalizada y su bloc de notas Sticky Notes en su tamaño más popular.

DE > Doppelte Wirkung für Ihre Marke dank vollständig personalisierter Deckseite und Haftnotizen-Notizblock im beliebtesten Format.

IT > Un doppio impatto per il tuo messaggio con la copertina e il blocco Sticky Notes, nel formato più diffuso, personalizzati.

Paper type:

Type de papier / tipo de papel / Papierart / Tipo carta

Standard 80g

Optional Packaging:

Emballage en option / Envasado opcional / Verpackung auf Wunsch / Imballaggio opzionale

Shrink-wrapped: 10 Booklets

Printing techniques:

Techniques d'impression / Técnicas de impresión / Drucktechniken / Tecniche di stampa



(DG) DIGITAL



MADE IN SPAIN

Decoration:

Personalisation / Personalización /
Dekoration / Decorazione

BIC® 101 x 75 Booklet

E/F/G/H DG: 4-colour process

25 3738

50 3739

MOA with unimprinted pad: 250v / MOA with imprinted pad: 500v.
MOA with imprinted pad: 250v.

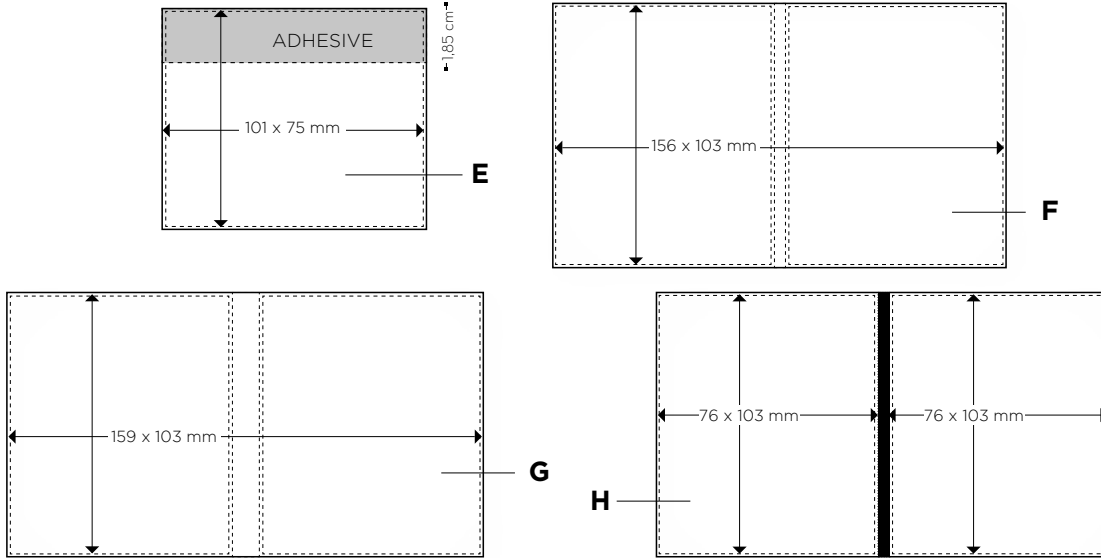

Price (€)

	BIC® 101 x 75 Booklet	250-444	500-444	1000-2444	2500-4444	5000-4444	10000-24444	25000-44444
25	3738*							
DG		1,96	1,63	1,43	1,22	1,12	1,10	1,08
50	3739							
DG		2,59	2,18	1,91	1,59	1,47	1,44	1,41

ADDITIONAL CHARGES Coûts supplémentaires / cargos adicionales / aufpreise / costi aggiuntivi

Exact colour match on pad Tampographie avec correspondance exacte des couleurs / Color exacto en el bloc / Genaue Farbübereinstimmung beim Block / Esatta corrispondenza di colore su tampone 105€

Printing on pad Impression sur le bloc / Impresión en el bloc / Druck auf dem Block / Stampa sul blocco
0,08 0,07 0,07 0,07 0,06 0,06 0,06

Printing on inside cover Impression sur la couverture intérieure / Impresión en cubierta interior / Druck auf der Innenseite des Covers / Stampa sull'interno della copertina
0,08 0,07 0,07 0,07 0,06 0,06 0,06

Matte soft-feel/pattern laminated finish Finition laminée mate au toucher doux / Acabado laminado mate soft-feel / Matt-softig laminierte Oberfläche / Finitura plastificata opaca morbida
0,08 0,07 0,07 0,07 0,06 0,06 0,06

Orders must be multiples of the minimum order quantity. Les commandes doivent être un multiple de la quantité minimum indiquée. Los pedidos deben ser múltiples de la cantidad mínima de pedido. Bestellungen müssen das Vielfache der Mindestbestellmenge (500/1000/ etc...). Gli ordini devono essere multipli della quantità minima.

BIC® Booklets: Prices include 4-colour process imprint only on the external part of the cover. Les prix incluent l'impression en quadrichromie seulement sur la couverture extérieure. Los precios incluyen impresión en cuatricromía sólo en el exterior de la cubierta. Preis inklusive Vierfarbdruck nur auf der Außenseite des Covers. I prezzi includono solo il processo di stampa in quadricromia sull'esterno della copertina

Additional charge for shrink-wrapped pack / Coût additionnelle pour emballage sous film / Coste adicional por el retractilado / Aufpreis für eingeschweißte Einzel- / Mehrverpackung / Supplemento per blister: 0,1€

* <500 units only possible with unprinted BIC® Sticky Notes / Commandes inférieures à 500 unités disponibles seulement avec BIC® Sticky Notes sans impression / * Pedidos inferiores a 500 unidades sólo disponibles con BIC® Sticky Notes sin impresión
* < 500 Stück nur mit unbedruckten BIC® Sticky Notes / * <500 unità possibile solo con BIC® Sticky Notes senza stampa

External packaging:

Emballage externe / Envasado exterior /
Außenverpackung / Imballaggio esterno



500 ± 5,9 Kg



250 ± 5,1 Kg

75 x 75 Adhesive Notepad with Flag Booklet



BIC STICKY NOTES

BOOKLETS

The multi-purpose notes tool

FR > Le bloc multifonction pour la prise de notes

ES > ¡El bloc de notas multiuso!

DE > Das Multitool für Ihre Notizen

IT > Il blocchetto multifunzione!

Paper type:

Type de papier / tipo de papel /
Papierart / Tipo carta

Standard 80g

Optional Packaging:

Emballage en option / Envasado opcional /
Verpackung auf Wunsch / Imballaggio opzionale

Shrink-wrapped: 10 Booklets

Printing techniques:

Techniques d'impression / Técnicas de impresión /
Drucktechniken / Tecniche di stampa



(DG) DIGITAL



MADE IN SPAIN



Decoration:

Personnalisation / Personalización / Dekoration / Decorazione

BIC® Adhesive Notepad
With Flag Booklet

A/B/C DG: 4-colour process

MOQ with unimprinted pad: 250v.
MOQ with imprinted pad: 500v.

25 3732

25 Flags per color

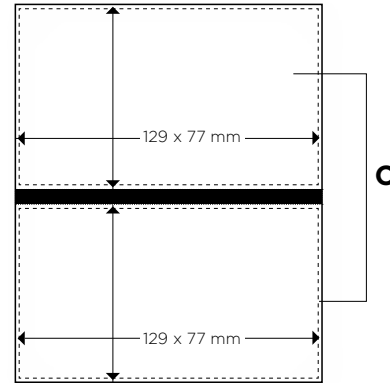
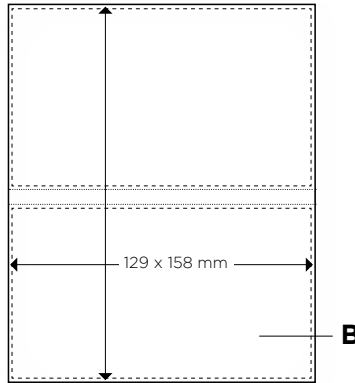
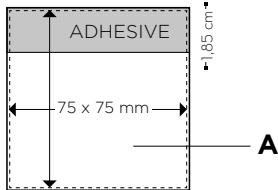

Price (€)

BIC® Adhesive Notepads
With Flag Booklet
3732*

250-499 500-999 1000-2499 2500-4999 5000-9999 10000-24999 25000-49999

DG	3,66	3,05	2,50	1,88	1,65	1,62	1,59
----	------	------	------	------	------	------	------

ADDITIONAL CHARGES Coûts supplémentaires / cargos adicionales / aufpreise / costi aggiuntivi

Exact colour match on pad Tampographie avec correspondance exacte des couleurs / Color exacto en el bloc / Genaue Farbübereinstimmung beim Block / Esatta corrispondenza di colore su tampone 105€

Printing on pad Impression sur le bloc / Impresión en el bloc / Druck auf dem Block / Stampa sul blocco	0,08	0,07	0,07	0,07	0,06	0,06	0,06
--	------	------	------	------	------	------	------

Printing on inside cover Impression sur la couverture intérieure / Impresión en cubierta interior / Druck auf der Innenseite des Covers / Stampa sull'interno della copertina	0,08	0,07	0,07	0,07	0,06	0,06	0,06
--	------	------	------	------	------	------	------

Matte soft-feel/pattern laminated finish Finition laminée mate au toucher doux / Acabado laminado mate soft-feel / Matt-softig laminierte Oberfläche / Finitura plastificata opaca morbida	0,08	0,07	0,07	0,07	0,06	0,06	0,06
---	------	------	------	------	------	------	------

Orders must be multiples of the minimum order quantity. Les commandes doivent être un multiple de la quantité minimum indiquée. Los pedidos deben ser múltiples de la cantidad mínima de pedido. Bestellungen müssen das Vielfache der Mindestbestellmenge (500/1000/ etc...). Gli ordini devono essere multipli della quantità minima.

BIC® Booklets: Prices include 4-colour process imprint only on the external part of the cover. Les prix incluent l'impression en quadrichromie seulement sur la couverture extérieure. Los precios incluyen impresión en cuatricromía sólo en el exterior de la cubierta. Preis inklusive Vierfarbdruck nur auf der Außenseite des Covers. I prezzi includono solo il processo di stampa in quadricromia sull'esterno della copertina

Additional charge for shrink-wrapped pack / Coût additionnelle pour emballage sous film / Coste adicional por el retráctilado / Aufpreis für eingeschweißte Einzel- / Mehrverpackung / Supplemento per blister: 0,11€

* <500 units only possible with unprinted BIC® Sticky Notes / Commandes inférieures à 500 unités disponibles seulement avec BIC® Sticky Notes sans impression / * Pedidos inferiores a 500 unidades sólo disponibles con BIC® Sticky Notes sin impresión / * < 500 Stück nur mit unbedruckten BIC® Sticky Notes / * <500 unità possibile solo con BIC® Sticky Notes senza stampa

External packaging:

Emballage externe / Envasado exterior / Außenverpackung / Imballaggio esterno



25

200 ± 5,2 Kg



Clic Stic Mini Organiser & BIC® Clic Stic Mini Digital Organiser

Bic® Clic Stic Mini Organiser
3735



Use this all-in-one organiser
for meeting and daily notes

BIC® STICKY NOTES

BOOKLETS

FR > Utilisez ce set de rangement tout-en-un pour vos réunions et vos notes quotidiennes

ES > Usa este organizador todo en uno para reuniones y notas de cada día

DE > Verwenden Sie diesen All-in-One-Organizer für Meetings oder Ihre alltäglichen Notizen

IT > Utilizza questo organizer tutto in uno per riunioni e appunti quotidiani.



This exceptional communication tool includes BIC® Clic Stic Mini Digital pen

Bic® Clic Stic Mini Digital organiser
3735



Photographic image all around!

FR > Cet article exceptionnel de communication comprend un stylo BIC® Clic Stic Mini Digital. Image photographique de toutes parts!

ES > Este excepcional artículo de comunicación incluye el bolígrafo BIC® Clic Stic Mini Digital. Imagen fotográfica en todas partes!

DE > Dieses außergewöhnliche Kommunikations-Tool beinhaltet den BIC® Clic Stic Mini- Digitalkugelschreiber. Photo-Image auf allen Seiten!

IT > Questo eccezionale strumento di comunicazione include la penna BIC® Clic Stic Mini Digital. Immagine fotografica dappertutto!





Clic Stic Mini Organiser & BIC® Clic Stic Mini Digital organiser

Standard colours combination

Combinaison de couleurs standards / Combinación de colores estandar / Standardfarbkombination / Combinazione colori standard



Plug

Bouton / Botón / Endstück / Pulsante

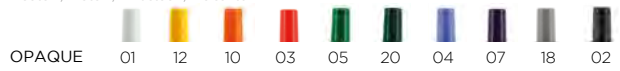
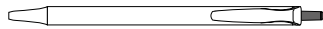

Clip

Clip / Clip / Clip / Clip

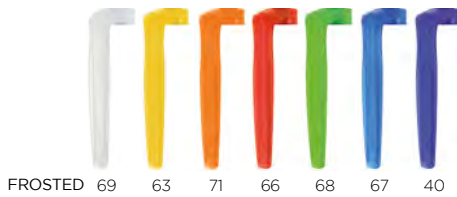
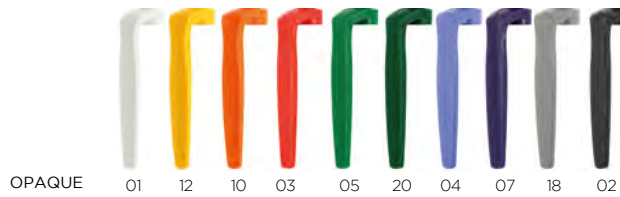

Section

Section / Sección / Teil / Sezione

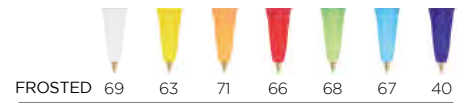

Barrel

Corps / Cuerpo / Schaft / Fusto



BIC® STICKY NOTES

BOOKLETS

Paper type:

Type de papier / tipo de papel / Papierart / Tipo carta

Standard 80g

Optional Packaging:

Emballage en option / Envasado opcional / Verpackung auf Wunsch / Imballaggio opzionale

Shrink-wrapped: 10 Booklets

Printing techniques:

Techniques d'impression / Técnicas de impresión / Drucktechniken / Tecniche di stampa



(DG) DIGITAL

External packaging:

Emballage externe / Envasado exterior / Außenverpackung / Imballaggio esterno



125 ± 7 Kg



MADE IN SPAIN



Decoration:

Personalisation / Personalización /
Dekoration / Decorazione

MOQ with unimprinted pad: 250v.
MOQ with imprinted pad: 500v.

Bic® Clic Stic Mini Organiser & Digital 3735

A/B/C DG: 4-colour process.

D/E SP: max 1 colour

F DG: full-colour (area for text)
(available in white barrel)

G DG: full-colour (area for images)
(available in white barrel)

 20 Adhesive notepad

 40 Scratch pad

 25 Flags per color

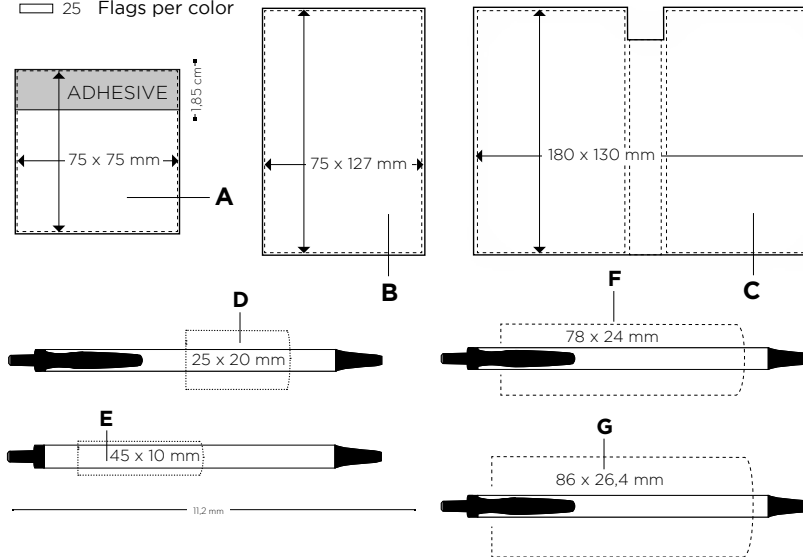

Price (€)

Bic® Clic Stic Mini Organiser /
Mini Digital organiser

	250-499	500-999	1000-2499	2500-4999	5000-9999	10000-24999	25000-49999
DG/SP	5,21	4,33	3,93	3,48	3,23	①	①
DG/DG	5,60	4,65	4,21	3,72	3,49	①	①

ADDITIONAL CHARGES Coûts supplémentaires / cargos adicionales / aufpreise / costi aggiuntivi

	250-499	500-999	1000-2499	2500-4999	5000-9999	10000-24999	25000-49999
Exact colour match on pad Tampographie avec correspondance exacte des couleurs / Color exacto en el bloc / Genaue Farbübereinstimmung beim Block / Esatta corrispondenza di colore su tampone							105€
Printing on pad Impression sur le bloc / Impresión en el bloc / Druck auf dem Block / Stampa sul blocco	0,08	0,07	0,07	0,07	0,06	0,06	0,06
Printing on inside cover Impression sur la couverture intérieure / Impresión en cubierta interior / Druck auf der Innenseite des Covers / Stampa sull'interno della copertina	0,08	0,07	0,07	0,07	0,06	0,06	0,06
Matte soft-feel/pattern laminated finish Finition laminée mate au toucher doux / Acabado laminado mate soft-feel / Matt-softig laminierte Oberfläche / Finitura plastificata opaca morbida	0,08	0,07	0,07	0,07	0,06	0,06	0,06

Orders must be multiples of the minimum order quantity. Les commandes doivent être un multiple de la quantité minimum indiquée. Los pedidos deben ser múltiples de la cantidad mínima de pedido. Bestellungen müssen das Vielfache der Mindestbestellmenge (500/1000/ etc...). Gli ordini devono essere multipli della quantità minima.

BIC® Booklets: Prices include 4-colour process imprint only on the external part of the cover. Les prix incluent l'impression en quadrichromie seulement sur la couverture extérieure. Los precios incluyen impresión en cuatricromía sólo en el exterior de la cubierta. Preis inklusive Vierfarbdruck nur auf der Außenseite des Covers. I prezzi includono solo il processo di stampa in quadricromia sull'esterno della copertina.

Additional charge for shrink-wrapped pack / Coût additionnelle pour emballage sous film / Coste adicional por el retractilado / Aufpreis für eingeschweißte Einzel-/ Mehrverpackung / Supplemento per blister: 0,11€

① Price under request. Prix sur demande. Precio bajo consulta. Preis auf Anfrage. Prezzi su richiesta.

150 x 150 mm Booklet organiser

BIC STICKY NOTES

BOOKLETS



60%

Create a unique notepad with this large format!

FR > Créez un carnet de notes unique avec ce format large!

ES > ¡Crea un bloc de notas único con este gran formato!

DE > Kreieren Sie einen einzigartigen Notizblock mit diesem großen Format!

IT > Crea un blocco note davvero unico con questo grande formato!

Paper type:

Type de papier / tipo de papel / Papierart / Tipo carta

Standard 80g

Optional Packaging:

Emballage en option / Envasado opcional / Verpackung auf Wunsch / Imballaggio opzionale

Shrink-wrapped: 10 Booklets

Printing techniques:

Techniques d'impression / Técnicas de impresión / Drucktechniken / Tecniche di stampa



(DG) DIGITAL



MADE IN SPAIN



Decoration:

Personalisation / Personalización / Dekoration / Decorazione

BIC® 150 x 150
Booklet organiser

MOQ 500v.

A/B/C DG: 4-colour process

100 3745

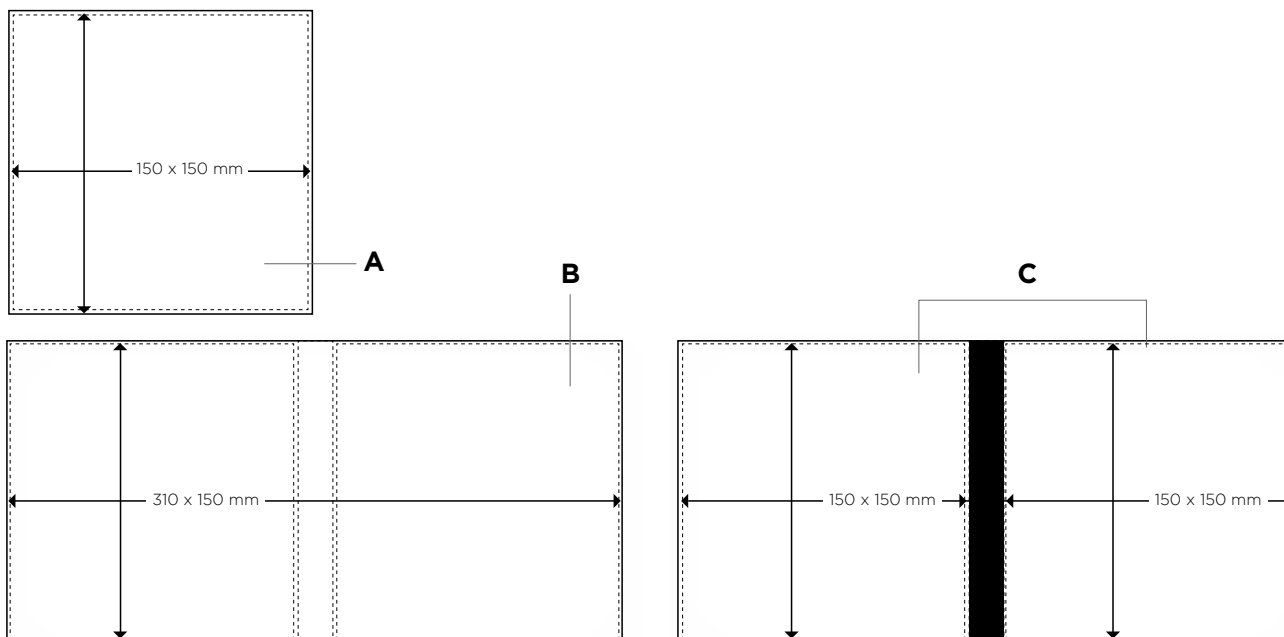

Price (€)

BIC® 150 x 150
Booklet organiser
3745

500-999 1000-2499 2500-4999 5000-9999 10000-24999 25000-49999

DG	5,10	4,74	4,25	3,96	①	①
----	------	------	------	------	---	---

ADDITIONAL CHARGES Coûts supplémentaires / cargos adicionales / aufpreise / costi aggiuntivi

Exact colour match on pad Tampographie avec correspondance exacte des couleurs / Color exacto en el bloc / Genaue Farbübereinstimmung beim Block / Esatta corrispondenza di colore su tampone 105€

Printing on pad Impression sur le bloc / Impresión en el bloc / Druck auf dem Block / Stampa sul blocco	0,07	0,07	0,07	0,06	0,06	0,06
--	------	------	------	------	------	------

Printing on inside cover Impression sur la couverture intérieure / Impresión en cubierta interior / Druck auf der Innenseite des Covers / Stampa sull'interno della copertina

	0,07	0,07	0,07	0,06	0,06	0,06
--	------	------	------	------	------	------

Matte soft-feel/pattern laminated finish Finition laminée mate au toucher doux / Acabado laminado mate soft-feel / Matt-softig laminierte Oberfläche / Finitura plastificata opaca morbida

	0,07	0,07	0,07	0,06	0,06	0,06
--	------	------	------	------	------	------

Orders must be multiples of the minimum order quantity. Les commandes doivent être un multiple de la quantité minimum indiquée. Los pedidos deben ser múltiples de la cantidad mínima de pedido. Bestellungen müssen das Vielfache der Mindestbestellmenge (500/1000/ etc...). Gli ordini devono essere multipli della quantità minima.

BIC® Booklets: Prices include 4-colour process imprint only on the external part of the cover. Les prix incluent l'impression en quadrichromie seulement sur la couverture extérieure. Los precios incluyen impresión en cuatricromía sólo en el exterior de la cubierta. Preis inklusive Vierfarbdruck nur auf der Außenseite des Covers. I prezzi includono solo il processo di stampa in quadricromia sull'esterno della copertina

Additional charge for shrink-wrapped pack / Coût additionnelle pour emballage sous film / Coste adicional por el retráctilado / Aufpreis für eingeschweißte Einzel- / Mehrverpackung / Supplemento per blister: 0,11€

① Price under request. Prix sur demande. Precio bajo consulta. Preis auf Anfrage. Prezzi su richiesta.

External packaging:

Emballage externe / Envasado exterior / Außenverpackung / Imballaggio esterno



40 ± 6,4 Kg

BIC® 150 x 150 mm Booklet with Pen Loop

3746



Suggested presentation
with BIC® Wide Body™ Digital
Combine this item with any
of our writing products

40%

With Pen Loop

BIC® STICKY NOTES

BOOKLETS

	Price (€)					
BIC® 150 x 150 Booklet with Pen Loop	500-999	1000-2499	2500-4999	5000-9999	10000-24999	25000-49999
3746						
DG	6,07	5,66	5,04	4,72	①	①
Ballpen 1080						
DG	1,17	1,09	1,02	0,96	①	①

ADDITIONAL CHARGES Coûts supplémentaires / cargos adicionales / aufpreise / costi aggiuntivi

Exact colour match on pad Tamponographie avec correspondance exacte des couleurs / Color exacto en el bloc / Genaue Farbübereinstimmung beim Block / Esatta corrispondenza di colore su tampono 105€

Printing on pad Impression sur le bloc / Impresión en el bloc / Druck auf dem Block / Stampa sul blocco
0,07 0,07 0,07 0,06 0,06 0,06

Printing on inside cover Impression sur la couverture intérieure / Impresión en cubierta interior / Druck auf der Innenseite des Covers / Stampa sull'interno della copertina
0,07 0,07 0,07 0,06 0,06 0,06

Matte soft-feel/pattern laminated finish Finition laminée mate au toucher doux / Acabado laminado mate soft-feel / Matt-softig laminierte Oberfläche / Finitura plastificata opaca morbida
0,07 0,07 0,07 0,06 0,06 0,06

Orders must be multiples of the minimum order quantity. Les commandes doivent être un multiple de la quantité minimum indiquée. Los pedidos deben ser múltiples de la cantidad mínima de pedido. Bestellungen müssen das Vielfache der Mindestbestellmenge (500/1000/ etc...). Gli ordini devono essere multipli della quantità minima.

BIC® Booklets: Prices include 4-colour process imprint only on the external part of the cover. Les prix incluent l'impression en quadrichromie seulement sur la couverture extérieure. Los precios incluyen impresión en cuatricromía sólo en el exterior de la cubierta. Preis inklusive Vierfarbdruck nur auf der Außenseite des Covers. I prezzi includono solo il processo di stampa in quadricromia sull'esterno della copertina

Additional charge for shrink-wrapped pack / Coût additionnelle pour emballage sous film / Coste adicional por el retráctilado / Aufpreis für eingeschweißte Einzel- / Mehrverpackung / Supplemento per blister: 0,11€

Pen not included. Stylo non inclus. Bolígrafo no incluido. Ohne Schreibgerät. Penna non inclusa.

① Price under request. Prix sur demande. Precio bajo consulta. Preis auf Anfrage. Prezzi su richiesta.

FR > Suggestion de présentation avec le BIC® Wide Body™ Digital. Combinez cet article avec n'importe quel produit d'écriture. Avec porte-stylo

ES > Sugerencia de presentación con BIC® Wide Body™ Digital. Combine este artículo con cualquiera de nuestros productos de escritura. ¡Soporte para poner el bolígrafo!

DE > Empfohlene Anwendung mit BIC® Wide Body™ Digital. Kombinieren Sie diesen Artikel mit einem unserer Schreibgeräte. Mit Halterung für Kugelschreiber

IT > Abbina questo prodotto con uno dei nostri articoli da scrittura. Prodotto consigliato. BIC® Wide Body™ Digital. Con asola per penna

Paper type:

Type de papier / tipo de papel / Papierart / Tipo carta

Standard 80g

Optional Packaging:

Emballage en option / Envasado opcional / Verpackung auf Wunsch / Imballaggio opzionale

Shrink-wrapped: 10 Booklets

Printing techniques:

Techniques d'impression / Técnicas de impresión / Drucktechniken / Tecniche di stampa



(DG) DIGITAL

External packaging:

Emballage externe / Envasado exterior / Außenverpackung / Imballaggio esterno



40 ± 6,7 Kg



MADE IN SPAIN



Decoration:

MOQ 500v.

Personalisation / Personalización /
Dekoration / Decorazione

BIC® 150 x 150 Booklet
With Pen Loop

A/B/C DG: 4-colour process

D/F SP: max. 2 col.

E/I SP: max. 1 col.

G DG: full-colour (area for images)

H DG: full-colour (area for text)

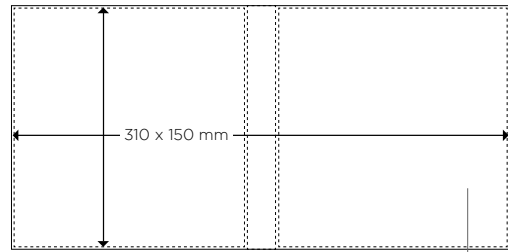
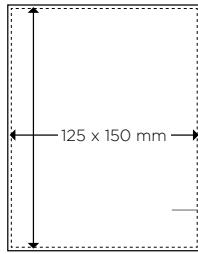

100 3746

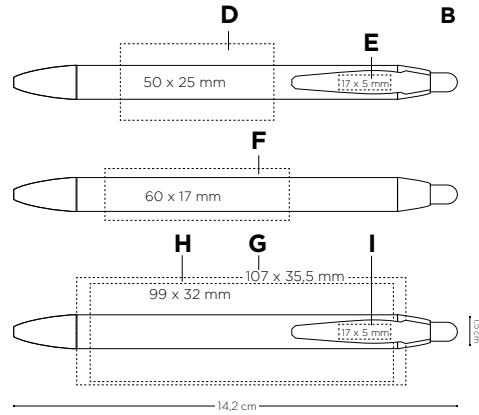
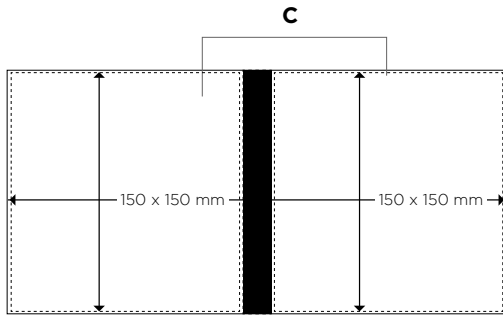

Standard colours combination

Combinaison de couleurs standards / Combinación de colores estandar / Standardfarbcombination / Combinazione colori standard

Barrel

Corps / Cuerpo / Schaft / Fusto



OPAQUE 01



Plug

Bouton / Botón / Endstück / Pulsante



OPAQUE 01 03 07 18 02



FROSTED 69 63 71 66 68 67 40

Clip

Clip / Clip / Clip / Clip

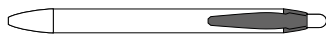

OPAQUE 01 03 07 18 02



FROSTED 69 63 71 66 68 67 40

Section

Section / Sección / Teil / Sezione



OPAQUE 01 03 07 18 02



FROSTED 69 63 71 66 68 67 40



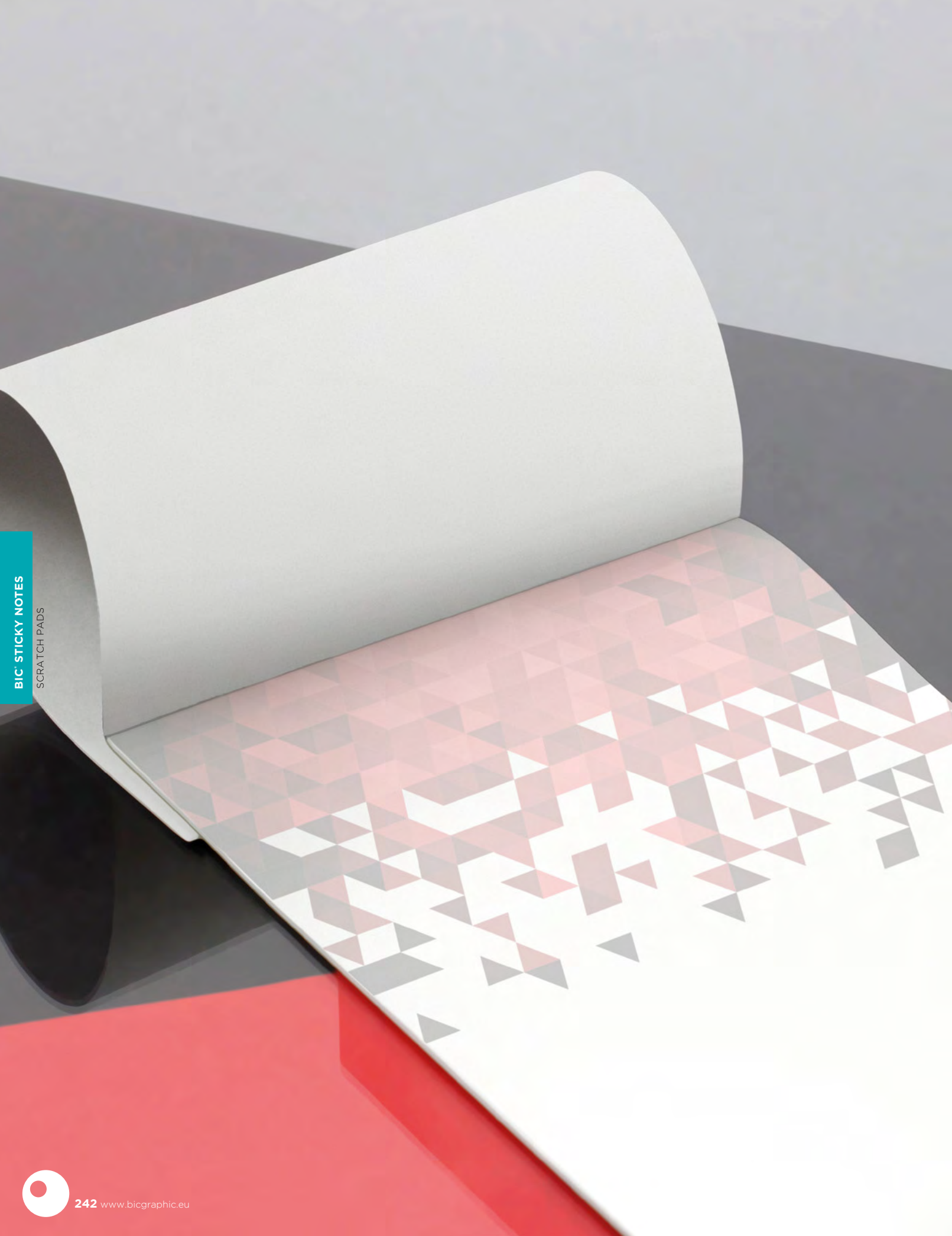

BIC STICKY NOTES

SCRATCH PADS



Scratch Pads

Indispensable scratch pad for lists and quick notes.

FR > L'outil indispensable pour vos notes et mémos.

ES > Bloc de notas indispensable para hacer listas y tomar notas rápidas.

DE > Unverzichtbarer Notizblock für Listen und schnelle Notizen.

IT > Blocco note indispensabile per fare liste e prendere appunti veloci



SCRATCH PADS
BIC STICKY NOTES



75 x 127 mm Non-Adhesive Scratch Pad

3760 / 3761

Indispensable scratch pad for lists and quick notes



MOQ 500v.

Decoration:

Personalisation / Personalización / Dekoration / Decorazione

BIC® 75 x 127 Non-Adhesive Scratch Pad

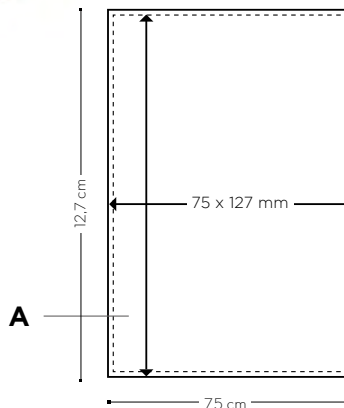

A DG: 4-colour process



BIC® STICKY NOTES

SCRATCH PADS

Price (€)

		BIC® 75 x 127 Non-Adhesive Scratch Pad					
		500-499	1000-2499	2500-4999	5000-9999	10000-24999	25000-49999
	20	3760					
	DG	0,51	0,42	0,25	0,19	0,19	0,19
	40	3761					
	DG	0,76	0,59	0,38	0,34	0,33	0,32

ADDITIONAL CHARGES Coûts supplémentaires / cargos adicionales / aufpreise / costi aggiuntivi

Exact colour match on pad Tampographie avec correspondance exacte des couleurs / Color exacto en el bloc / Genaue Farbübereinstimmung beim Block / Esatta corrispondenza di colore su tampone 105€

Prices include 4-colour process imprint. Les prix incluent l'impression en quadrichromie. Los precios incluyen una impresión en cuatricromía. In den Preisen inbegriffen ist der Vierfarbdruck-Aufdruck. I prezzi includono la stampa con processo in quadricromia.

Orders must be multiples of the minimum order quantity. Les commandes doivent être un multiple de la quantité minimum indiquée. Los pedidos deben ser múltiplos de la cantidad mínima de pedido. Bestellungen müssen das Vielfache der Mindestbestellmenge (500/1000/ etc...). Gli ordini devono essere multipli della quantità minima.

Additional charge for shrink-wrapped pack / Coût additionnelle pour emballage sous film: Coste adicional por el retráctilado / Aufpreis für eingeschweißte Einzel- / Mehrverpackung / Supplemento per blister: 0,11€

FR > L'outil indispensable pour vos notes et mémos.

ES > Bloc de notas indispensable para hacer listas y tomar notas rápidas.

DE > Unverzichtbarer Notizblock für Listen und schnelle Notizen.

IT > Blocco note indispensabile per fare liste e prendere appunti veloci

Paper type:

Type de papier / tipo de papel / Papierart / Tipo carta

Standard 80g

Printing techniques:

Techniques d'impression / Técnicas de impresión / Drucktechniken / Tecniche di stampa



(DG) DIGITAL

External packaging:

Emballage externe / Envasado exterior / Außenverpackung / Imballaggio esterno



 20

400 ± 5,4 Kg



 40

200 ± 5,2 Kg



MADE IN SPAIN





96 x 152 mm Non-Adhesive Scratch Pad

3762 / 3763



MOQ 500v.

Decoration:

Personnalisation / Personalización /
Dekoration / Decorazione

BIC® 96 x 152 Non-Adhesive
Scratch Pad

A DG: 4-colour process

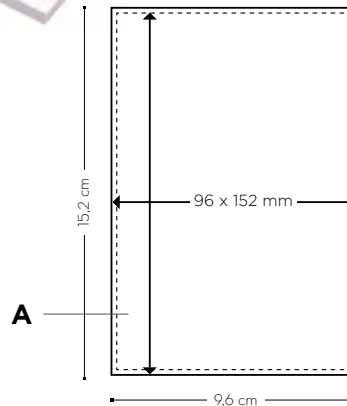

Price (€)

		500-999	1000-2499	2500-4999	5000-9999	10000-24999	25000-49999
20	3762						
	DG	0,63	0,52	0,30	0,24	0,24	0,24
40	3763						
	DG	0,96	0,76	0,48	0,43	0,42	0,41

ADDITIONAL CHARGES Coûts supplémentaires / cargos adicionales / aufpreise / costi aggiuntivi

Exact colour match on pad Tampographie avec correspondance exacte des couleurs / Color exacto en el bloc / Genaue Farbübereinstimmung beim Block / Esatta corrispondenza di colore su tampone 105€

Prices include 4-colour process imprint. Les prix incluent l'impression en quadrichromie. Los precios incluyen una impresión en cuatricromía. In den Preisen inbegriffen ist der Vierfarbdruck-Aufdruck. I prezzi includono la stampa con processo in quadricromia.

Orders must be multiples of the minimum order quantity. Les commandes doivent être un multiple de la quantité minimum indiquée. Los pedidos deben ser múltiples de la cantidad mínima de pedido. Bestellungen müssen das Vielfache der Mindestbestellmenge (500/1000/ etc...). Gli ordini devono essere multipli della quantità minima.

Additional charge for shrink-wrapped pack / Coût additionnelle pour emballage sous film: Coste adicional por el retractilado / Aufpreis für eingeschweißte Einzel- / Mehrverpackung / Supplemento per blister: 0,11€

Paper type:

Type de papier / tipo de papel /
Papierart / Tipo carta

Standard 80g

Printing techniques:

Techniques d'impression / Técnicas de impresión /
Drucktechniken / Tecniche di stampa



(DG) DIGITAL

External packaging:

Emballage externe / Envasado exterior /
Außenverpackung / Imballaggio esterno



350 ± 8,6 Kg

20



200 ± 8 Kg

40



MADE IN
SPAIN

SCRATCH PADS
BIC® STICKY NOTES

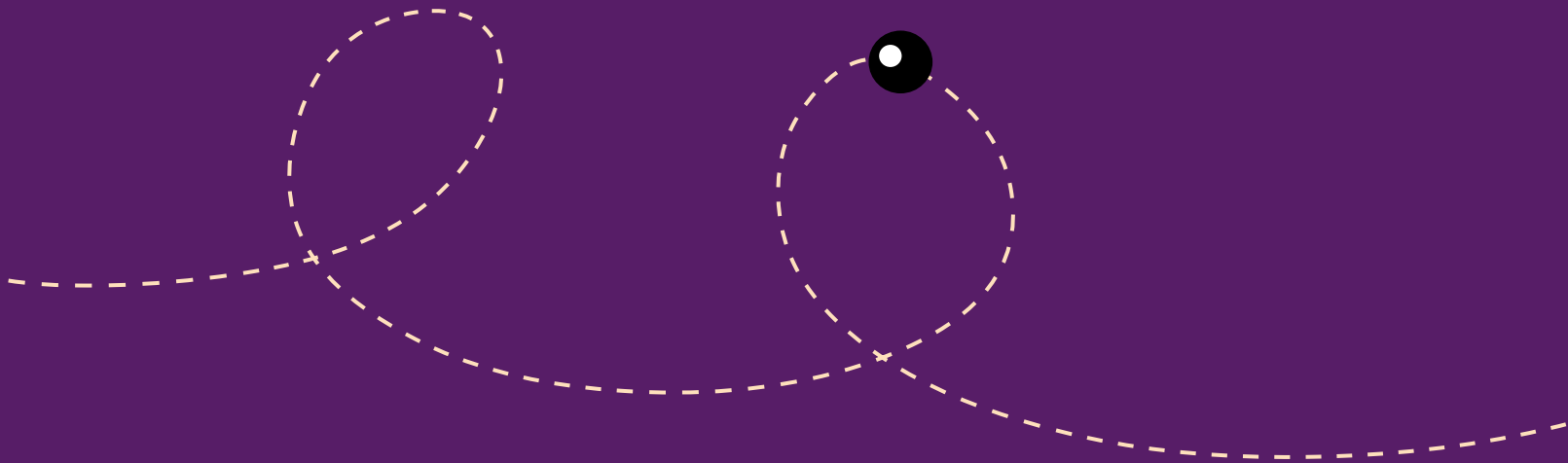

PU COVER NOTEBOOKS

250 BIC® Notebooks Dual A5

252 BIC® Notebooks Dual A6





 **BiC**® Notebooks



Stand out from the crowd with this personalisable notebook! Create the product you need for each event by combining the PU cover colour with the stack of paper inside. The integrated pen loop in the spine is a practical way to always take your BIC® ballpen with you.

FR > Démarquez-vous de la concurrence grâce à ce carnet de notes personnalisable et signé BIC® ! Créez le produit dont vous avez besoin pour chaque événement en combinant la couleur de la couverture en PU et celle des feuilles à l'intérieur. Le porte-stylo intégré est pratique pour avoir toujours votre stylo-bille BIC® avec vous.

ES > ¡Destaca entre la multitud con esta libreta personalizable! Crea el producto que necesitas para cada evento combinando la cubierta de color en PU con el bloc de notas de papel en el interior. El soporte para el bolígrafo intergrado en el lomo es la manera más práctica de llevar tu bolígrafo BIC® contigo.

DE > Seien Sie anders als alle anderen mit diesem personalisierbaren Notizbuch! Kreieren Sie für jede Veranstaltung das Produkt, das Sie brauchen, indem Sie die Farbe des PU-Einbands mit dem Papier im Notizbuch kombinieren. Mit dem praktischen integrierten Kugelschreiberhalter am Rücken können Sie Ihren BIC®-Kugelschreiber immer dabei haben.

IT > Fatti notare con questo blocco note personalizzabile! Crea il prodotto di cui hai bisogno per ogni evento combinando il colore della copertina in PU con la carta al suo interno. L'asola per penna incorporata nel dorso è un modo pratico per portare la tua penna a sfera BIC® sempre con te.

BIC Notebooks Dual A5/A6

COVER - 3721(A5)/3725(A6)

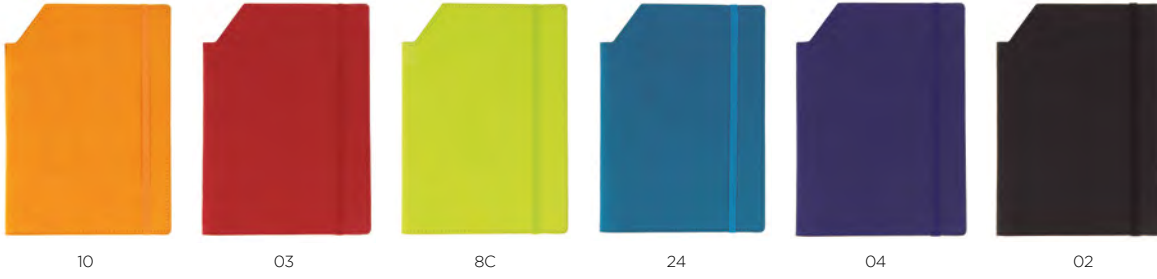

MIX & MATCH

INNER NOTEPAD - 3724(A5)/3712(A6)

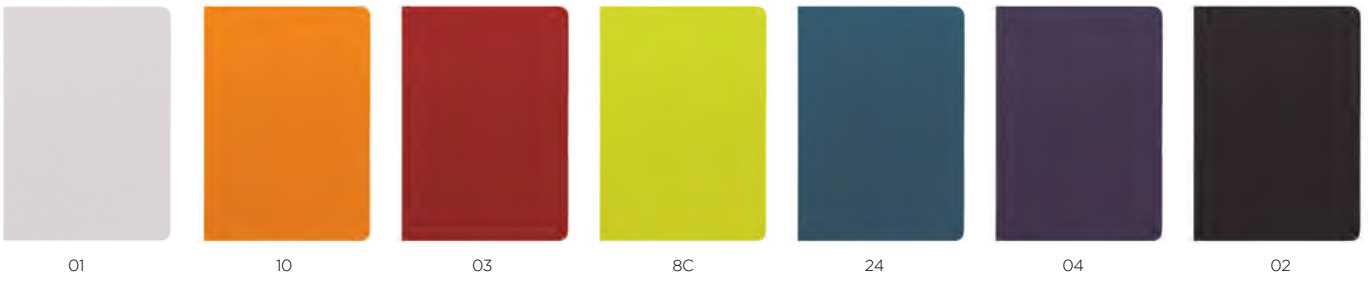

PU COVER NOTEBOOKS
BIC® NOTEBOOKS

Create your own combination,
choose a cover and notepad colour!



02



8C



FR > Créez votre propre combinaison : choisissez la couleur de la couverture et celle des carnets à l'intérieur.

ES > ¡Crea tu propia combinación! Escoge un color de portada y bloc de notas

DE > Kreieren Sie Ihre eigene Kombination, wählen Sie die Farbe von Einband und Notizblock.

IT > Crea la tua combinazione, scegli un colore di copertina e di Notepad!



BIC® Notebooks Dual A5

MOQ 500.

Standard colours combination

Combinaison de couleurs standards / Combinación de colores estandar / Standardfarbkombination / Combinazione colori standard



Cover



10 03 8C 24 04 02

Inner notepad



01 10 03 8C 24 04 02

Create your own combination, choose a cover and notepad colour!

FR > Créez votre propre combinaison : choisissez la couleur de la couverture et celle des carnets à l'intérieur.

ES > ¡Crea tu propia combinación! Escoge un color de portada y bloc de notas

DE > Kreieren Sie Ihre eigene Kombination, wählen Sie die Farbe von Einband und Notizblock.

IT > Crea la tua combinazione, scegli un colore di copertina e di Notepad!

Decoration:

Personnalisation / Personalización / Dekoration / Decorazione

BIC® Notebooks Dual A5

Cover 3721

A SP: max. 1 col.

B DB/HS: max. 1 col.

C SP: full cover max 1 col.

New!

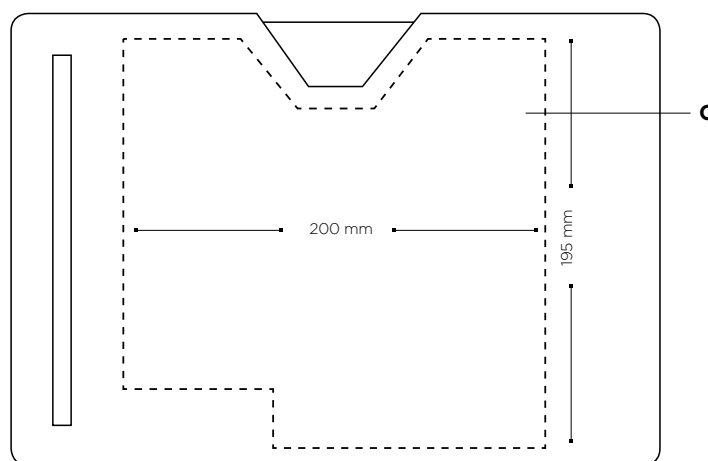
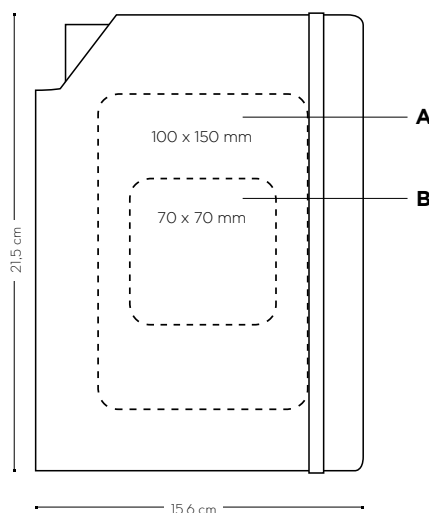

New imprint area!

BIC® Notebooks Dual A5

Cover 3721

	50-99	100-249	250-499	500-999	1000-2499	2500-4999	5000-9999
SP	9,98	9,28	8,83	8,49	8,15	①	①
SP full cover	11,19	10,29	9,75	9,32	8,89	①	①
DB/HS	10,86	10,08	9,60	9,23	8,86	①	①

Prices include one imprint in one position according to specified technique. Les prix incluent une impression sur un emplacement avec la technique spécifiée / Los precios incluyen una impresión en una posición acorde con la técnica especificada / In den Preisen inbegriffen ist ein Aufdruck auf einer Position gemäß angegebener Technik / I prezzi includono una stampa in una posizione a seconda della tecnica specificata.

① Price under request. Prix sur demande. Precio bajo consulta. Preis auf Anfrage. Prezzi su richiesta.

	50-99	100-249	250-499	500-999	1000-2499	2500-4999	5000-9999
Add a BIC® ballpen to your BIC® Notebook							



BIC® Media Clic	2,86	1,78	0,93	0,60	0,56	①	①
------------------------	------	------	------	------	------	---	---



BIC® Super Clip	3,42	1,99	1,01	0,97	0,93	①	①
------------------------	------	------	------	------	------	---	---



BIC® 4 Colours	4,41	3,56	2,88	2,61	2,42	2,26	①
-----------------------	------	------	------	------	------	------	---

Prices include 1 colour screenprint in one position. Les prix incluent la sérigraphie 1 couleur sur un emplacement. En precio incluye un color en serigrafía en una posición. In den Preisen inbegriffen ist 1 Siebdruck-Farbaufdruck auf 1 Position. I prezzi includono 1 colore a serigrafia in una posizione.

① Price under request. Prix sur demande. Precio bajo consulta. Preis auf Anfrage. Prezzi su richiesta.

Paper type:

type de papier / tipo de papel / papierart / tipo carta

80 Standard 80g

80 Standard 80g

Printing techniques:

Techniques d'impression / Técnicas de impresión / Drucktechniken / Tecniche di stampa



(SP) SCREEN PRINTING



(DB) DEBOSSING



(HS) HOT STAMPING

External packaging:

Emballage externe / Envasado exterior / Außenverpackung / Imballaggio esterno



35 ± 8,6 Kg

BIC® Notebooks Dual A5 Inner notepad

MOQ 50v.

Use the inner notepad to refill your Dual Cover, or as a notebook itself!

FR > Créez votre propre combinaison : choisissez la couleur de la couverture et celle des carnets à l'intérieur.

DE > Nutzen Sie den Notizblock im Innern zum Nachfüllen Ihres Dual Cover oder als separates Notizbuch!

ES > ¡Usa el bloc de notas interior para recargar tu Dual cover, o como libreta!

IT > Usa la parte interna del taccuino per ricaricare il dual cover o come notebook



Decoration:

Personnalisation / Personalización / Dekoration / Decorazione

Inner notepad 3724

D SP: max. 1 col.

E DB/HS: max. 1 col.

F BP: full-colour

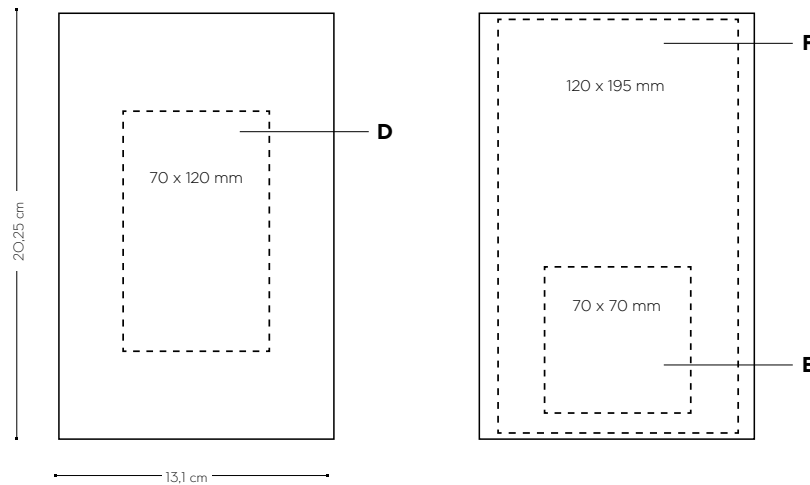

	Price (€)						
BIC® Notebooks Dual A5	50-99	100-249	250-499	500-999	1000-2499	2500-4999	5000-9999
Inner notepad 3724							
SP	5,17	4,79	4,56	4,39	4,21	①	①
DB/HS	6,03	5,59	5,33	5,13	4,92	①	①
BP	9,49	8,83	8,50	8,17	7,84	①	①

Prices include one imprint in one position according to specified technique. Les prix incluent une impression sur un emplacement avec la technique spécifiée / Los precios incluyen una impresión en una posición acorde con la técnica especificada / In den Preisen inbegriffen ist ein Aufdruck auf einer Position gemäß angegebener Technik / I prezzi includono una stampa in una posizione a seconda della tecnica specificata.

① Price under request. Prix sur demande. Precio bajo consulta. Preis auf Anfrage. Prezzi su richiesta.

Paper type:

type de papier / tipo de papel / papierart / tipo carta

80 Standard 80g

80 Standard 80g

Printing techniques:

Techniques d'impression / Técnicas de impresión / Drucktechniken / Tecniche di stampa



(SP) SCREEN PRINTING



(DB) DEBOSSING



(HS) HOT STAMPING



(BP) britePix™



External packaging:

Emballage externe / Envasado exterior / Außenverpackung / Imballaggio esterno



55 ± 10,7 Kg

BIC® Notebooks Dual A6

MOQ 500.

Standard colours combination

Combinaison de couleurs standards / Combinación de colores estandar / Standardfarbkombination / Combinazione colori standard



Cover



10 03 8C 24 04 02

Inner notepad



01 10 03 8C 24 04 02

Create your own combination, choose a cover and notepad colour!

Decoration:

Personnalisation / Personalización / Dekoration / Decorazione

FR > Créez votre propre combinaison : choisissez la couleur de la couverture et celle des carnets à l'intérieur.

ES > ¡Crea tu propia combinación! Escoge un color de portada y bloc de notas

DE > Kreieren Sie Ihre eigene Kombination, wählen Sie die Farbe von Einband und Notizblock.

IT > Crea la tua combinazione, scegli un colore di copertina e di Notepad!

BIC® Notebooks Dual A6

Cover 3725

A SP: max. 1 col.

B DB/HS: max. 1 col.

C SP: full cover max 1 col.

New!

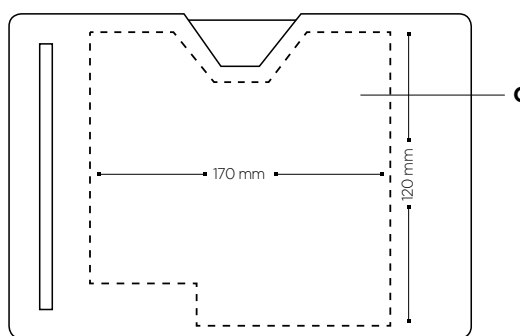
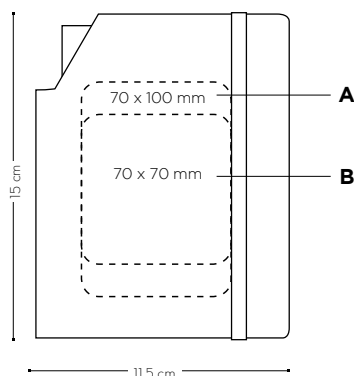

New imprint area!

BIC® Notebooks Dual A6

	50-99	100-249	250-499	500-999	1000-2499	2500-4999	5000-9999
Cover 3725							
SP	7,34	6,81	6,48	6,23	5,98	①	①
SP full cover	8,53	7,82	7,40	7,06	6,72	①	①
DB/HS	8,20	7,61	7,25	6,97	6,69	①	①

Price (€)

Prices include one imprint in one position according to specified technique. Les prix incluent une impression sur un emplacement avec la technique spécifiée / Los precios incluyen una impresión en una posición acorde con la técnica especificada / In den Preisen inbegriffen ist ein Aufdruck auf einer Position gemäß angegebener Technik / I prezzi includono una stampa in una posizione a seconda della tecnica specificata.

① Price under request. Prix sur demande. Precio bajo consulta. Preis auf Anfrage. Prezzi su richiesta.

Add a BIC® ballpen to your BIC® Notebook



	50-99	100-249	250-499	500-999	1000-2499	2500-4999	5000-9999
BIC® Media Clic	2,86	1,78	0,93	0,60	0,56	①	①
BIC® Super Clip	3,42	1,99	1,01	0,97	0,93	①	①
BIC® 4 Colours	4,41	3,56	2,88	2,61	2,42	2,26	①

Price (€)

Prices include 1 colour screenprint in one position. Les prix incluent la sérigraphie 1 couleur sur un emplacement. En precio incluye un color en serigrafía en una posición. In den Preisen inbegriffen ist 1 Siebdruck-Farbaufdruck auf 1 Position. I prezzi includono 1 colore a serigrafia in una posizione.

① Price under request. Prix sur demande. Precio bajo consulta. Preis auf Anfrage. Prezzi su richiesta.

Paper type:

type de papier / tipo de papel / papierart / tipo carta

- 60 Standard 80g
- 60 Standard 80g

Printing techniques:

Techniques d'impression / Técnicas de impresión / Drucktechniken / Tecniche di stampa



(SP) SCREEN PRINTING



(DB) DEBOSSING



(HS) HOT STAMPING

External packaging:

Emballage externe / Envasado exterior / Außenverpackung / Imballaggio esterno



50 ± 6 Kg



BIC® Notebooks Dual A6 Inner notepad

MOQ 50v.

Use the inner notepad to refill your Dual Cover, or as a notebook itself!

FR > Créez votre propre combinaison : choisissez la couleur de la couverture et celle des carnets à l'intérieur.

DE > Nutzen Sie den Notizblock im Innern zum Nachfüllen Ihres Dual Cover oder als separates Notizbuch!

ES > ¡Usa el bloc de notas interior para recargar tu Dual cover, o como libreta!

IT > Usa la parte interna del taccuino per ricaricare il dual cover o come notebook



Decoration:

Personnalisation / Personalización / Dekoration / Decorazione

Inner notepad 3712

D SP: max. 1 col.

E DB/HS: max. 1 col.

F BP: full-colour

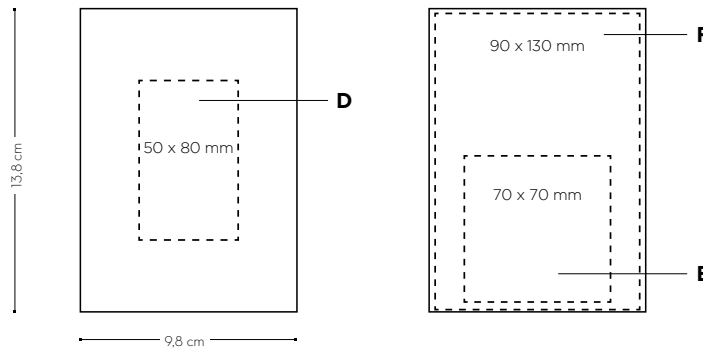

	Price (€)						
BIC® Notebooks Dual A6	50-99	100-249	250-499	500-999	1000-2499	2500-4999	5000-9999
Inner notepad 3712							
SP	3,82	3,54	3,37	3,24	3,11	①	①
DB/HS	4,68	4,34	4,14	3,98	3,82	①	①
BP	5,62	5,21	4,96	4,77	4,58	①	①

Prices include one imprint in one position according to specified technique. Les prix incluent une impression sur un emplacement avec la technique spécifiée / Los precios incluyen una impresión en una posición acorde con la técnica especificada / In den Preisen inbegriffen ist ein Aufdruck auf einer Position gemäß angegebener Technik / I prezzi includono una stampa in una posizione a seconda della tecnica specificata.

① Price under request. Prix sur demande. Precio bajo consulta. Preis auf Anfrage. Prezzi su richiesta.

Paper type:

type de papier / tipo de papel / papierart / tipo carta

60 Standard 80g

60 Standard 80g

Printing techniques:

Techniques d'impression / Técnicas de impresión / Drucktechniken / Tecniche di stampa



(SP) SCREEN PRINTING



(DB) DEBOSSING



(HS) HOT STAMPING



(BP) britePix™



External packaging:

Emballage externe / Envasado exterior / Außenverpackung / Imballaggio esterno



140 ± 11,4 Kg



OFFICE ACCESSORIES

258 Mouse pad

259 Sublimation mug





Office accessories





Office Accessories

A selection of great accessories for everyday use, functional no matter if at home or work.

FR > Une sélection d'accessoires de bureau hyper pratiques pour tous les jours, que vous soyez au bureau ou chez vous.

DE > Eine Auswahl toller Accessoires für jeden Tag, praktisch für zuhause und für die Arbeit.

ES > Una selección de estupendos accesorios para uso diario, funcionales, no importa si en casa o en la oficina

IT > Una gamma di fantastici accessori per l'uso quotidiano, funzionali sia a casa sia al lavoro.



15031



60%

OFFICE ACCESSORIES

MOUSE PAD

MOQ 50v.

Decoration:

Personnalisation / Personalización /
 Dekoration / Decorazione

Mouse Pad

15031

A SU: 4-colour process

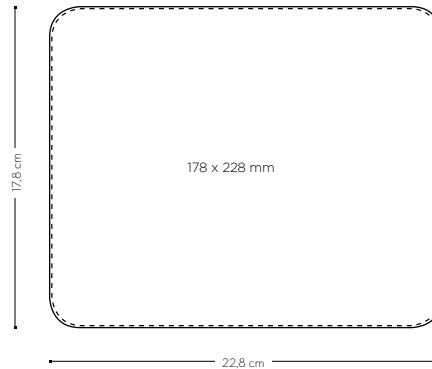

	Price (€)						
Mouse Pad	50-99	100-249	250-499	500-999	1000-2499	2500-4999	5000-9999
15031							
SU	5,09	4,17	3,55	3,24	3,03	①	①

Price includes digital imprint in sublimation. Le prix inclut l'impression numérique par sublimation. El precio incluye impresión digital en sublimación. Preis inklusive Sublimations-Digitaldruck. Il prezzo include stampa digitale sublimatica.

① Price under request. Prix sur demande. Precio bajo consulta. Preis auf Anfrage. Prezzi su richiesta.

Printing techniques:

Techniques d'impression / Técnicas de impresión /
 Drucktechniken / Tecniche di stampa



(SU) SUBLIMATION

External packaging:

Emballage externe / Envasado exterior /
 Außenverpackung / Imballaggio esterno



200 ± 9 Kg

3837



01

MOQ 50v.

Decoration:

Personnalisation / Personalización /
 Dekoration / Decorazione

Sublimation Mug

3837

A SU: 4-colour process

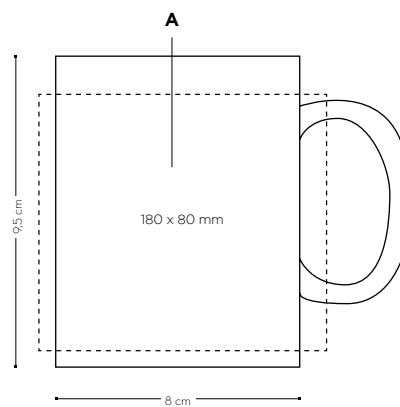

Sublimation Mug	Price (€)						
	50-99	100-249	250-499	500-999	1000-2499	2500-4999	5000-9999
3837							
SU	7,57	7,31	6,64	5,71	5,31	①	①

Price includes digital imprint in sublimation. Le prix inclut l'impression numérique par sublimation. El precio incluye impresión digital en sublimación. Preis inklusive Sublimations-Digitaldruck. Il prezzo include stampa digitale sublimatica.

① Price under request. Prix sur demande. Precio bajo consulta. Preis auf Anfrage. Prezzi su richiesta.

Printing techniques:

Techniques d'impression / Técnicas de impresión /
 Drucktechniken / Tecniche di stampa



(SU) SUBLIMATION

External packaging:

Emballage externe / Envasado exterior /
 Außenverpackung / Imballaggio esterno



36 ± 13 Kg

LIGHTERS

- 274 BIC® J23 Digital Lighter
- 272 BIC® J23 Lighter
- 270 BIC® J25 Digital Lighter
- 268 BIC® J25 Lighter
- 278 BIC® J26 Digital Lighter
- 276 BIC® J26 Lighter
- 282 BIC® J38 Digital Lighter
- 280 BIC® J38 Lighter
- 286 BIC® J39 Digital Lighter
- 284 BIC® J39 Lighter
- 288 BIC® Mega Lighter

LIGHTER CASES

- 295 BIC® 3D Case
- 292 BIC® Aluminium Flat Case
- 293 BIC® Clip Case
- 294 BIC® Styl'it Fashion Case
- 290 BIC® Styl'it Luxury Case

OTHER PRODUCTS

- 296 BIC® Pocket Ashtray





 **BIC** Lighters



FR> La sécurité, notre priorité
BIC® : LE N° 1 MONDIAL
EN BRIQUETS DE MARQUE

FLAMME STABLE
Grâce au combustible pur d'isobutane

CAPUCHON DE SÉCURITÉ
Fabriqué en acier résistant avec verrouillage de sécurité

HAUTE RÉSISTANCE
Réservoir fabriqué avec une résine technique (Delrin®) à haute résistance mécanique

SÉCURITÉ ENFANTS*
Conforme à la norme EN 13869

BRIQUET LONGUE DURÉE
Grâce au plus grand volume de gaz dans le réservoir: JUSQU'À 3 000 ALLUMAGES

BRIQUETS BIC®.
NOTRE QUALITÉ. VOTRE SÉCURITÉ

* Un briquet "sécurité enfants" n'est pas un briquet exempt de tout risque pour les enfants: c'est un briquet que 85% au moins des enfants de moins de 51 mois ne peuvent pas faire fonctionner, ce qui implique que la proportion des enfants en cause capables de l'actionner peut aller jusqu'à 15%. Les adultes doivent donc toujours veiller à ce que les briquets soient hors de portée des enfants, même s'il s'agit de briquets « sécurité enfants ».

DE> Die Sicherheit, unsere Priorität
BIC®: WELTWEIT DIE NR.1 UNTER DEN MARKEN-FEUERZEUGEN

STABILE FLAMME
Dank des reinen Isobutan-Brennstoffs

SICHERHEITSKAPPE
Aus widerstandsfähigem Stahl mit Sperrfunktion

BRUCHFEST
Behälter aus äußerst stoßfestem technischem Thermoplast (Delrin®)

KINDERSICHERUNG*
Erfüllt die Vorschrift
EN 13869

LANGLEBIGES FEUERZEUG
Dank des größeren Gasvolumens im Behälter: BIS ZU 3000 ZÜNDUNGEN

BIC®-FEUERZEUGE. UNSERE QUALITÄT.
IHRE SICHERHEIT

* Ein kindergesichertes Feuerzeug ist nicht unbedingt kindersicher. Als "kindergesichert" bezeichnet man Feuerzeuge, die von mindestens 85% der Kinder unter 51 Monaten nicht bedient werden können. Das bedeutet, dass bis zu 15% der Kinder diese Feuerzeuge möglicherweise bedienen können. Daher müssen Sie Feuerzeuge – auch wenn sie kindergesichert sind – stets außerhalb der Reichweite von Kleinkindern aufbewahren.

ES> La seguridad, nuestra prioridad
BIC®: LA MARCA N°1 EN TODO EL MUNDO EN ENCENDEDORES DE BOLSILLO

LLAMA ESTABLE
Gracias al combustible puro de isobutano

CAPUCHÓN DE SEGURIDAD
Hecho de acero resistente con función de bloqueo

ALTA RESISTENCIA Depósito hecho de resina de alta resistencia mecánica (Delrin®)

PROTECCIÓN A PRUEBA DE NIÑOS*
Cumple con la normativa EN 13869

ENCENDEDOR DE LARGA DURACIÓN
Gracias al gran volumen de gas en su depósito: HASTA 3.000 ENCENDIDOS

ENCENDEDORES BIC®.
NUESTRA CALIDAD, TU SEGURIDAD

* No es lo mismo un encendedor con seguridad para niños que un encendedor a prueba de niños. Por "encendedor con seguridad para niños" se entiende un encendedor que para un mínimo del 85% de los niños de hasta 51 meses de edad resulta imposible de accionar. Esto significa que hasta un 15% de los niños sí podrían hacer funcionar el encendedor. De ahí que los adultos deban siempre impedir que los niños jueguen con encendedores, por seguros que éstos sean.

IT> La sicurezza, la nostra priorità
BIC®: IL N° 1 MONDIALE PER GLI ACCENDINI TASCABILI DI MARCA

FIAMMA STABILE
Grazie all'isobutano puro

CAPPUCCIO DI SICUREZZA
Realizzato in acciaio resistente e con funzione di blocco

OTTIMA RESISTENZA
Serbatoio realizzato in resina ad alta resistenza meccanica (Delrin®)

DISPOSITIVO DI SICUREZZA PER BAMBINI*
Conforme allo standard
EN 13869

UN ACCENDINO DI LUNGA DURATA
Grazie a un maggior volume di gas nel serbatoio. FINO A 3000 ACCENSIONI

ACCENDINI BIC®
LA NOSTRA QUALITÀ, LA TUA SICUREZZA

* Un accendino dotato di dispositivo di sicurezza per i bambini non è un accendino a prova di bambino. Infatti, un accendino sicuro per i bambini è un accendino che almeno l'85% dei bambini di età inferiore a 51 mesi non è in grado di far funzionare. Ciò significa però che ben il 15% dei bambini potrebbe essere capace di azionare questo tipo di accendini. Per tale motivo, gli adulti dovrebbero sempre fare in modo che i bambini non possano impadronirsi di accendini, nemmeno qualora siano dotati di un dispositivo di sicurezza per i bambini.

safety, our priority

STABLE FLAME

Thanks to pure isobutane



SAFETY HOOD

Made of strong steel material with locking feature



HIGH RESISTANCE

Reservoir made of high mechanical resistance resin (Delrin®)



BIC® J26 Lighter

CHILD-RESISTANT SAFETY GUARD*

Compliant with EN 13869 Standard

*A Child-resistant lighter is not a child proof lighter. A Child-resistant lighter is a lighter that at least 85% of children under 51 months of age cannot operate. This means that up to 15% of children may still be able to operate such a lighter. Therefore, adults should always ensure that young children cannot get hold of lighters, even if they are Child-resistant.



A LONG LASTING LIGHTER

Thanks to a greater volume of gas in the reservoir **UP TO 3000 LIGHTS**



BIC® LIGHTERS

OUR QUALITY, YOUR SAFETY

BIC® Mega Lighter



Up to 750 🔥

BIC® J26 Digital Lighter

BIC® J38 Digital Lighter

BIC® J23 Digital Lighter

BIC® J25 Digital Lighter



Up to 1400 🔥



Up to 1800 🔥



Up to 3000 🔥



Up to 1800 🔥

BIC® J39 Digital Lighter



Up to 1050 🔥

LIGHTERS
BIC® LIGHTERS

FR> Finitions numériques et textures des briquets BIC®

Digital Brilliant / Digital matt

Brillante ou mate ? Choisissez la finition qui vous plaît !

Metallic

Créez de superbes effets ! Effets métalliques sur les textes, les images et le fond.

Holographic gold / Holographic silver

Démarquez-vous de la concurrence ! Jouez avec de jolis reflets légers de couleurs en utilisant la finition holographique.

Puffy printing

Faites preuve d'originalité ! Faites ressortir votre marque grâce à notre encre « puffy » et donnez ainsi du relief à votre logo.

UV printing

Faites ressortir votre marque avec une finition très brillante ! Combinez les finitions mates et brillantes pour souligner les contrastes et faire ressortir le motif sur fond mat.

Sandy

Créez un effet « papier de verre » grâce à une surface granuleuse.

Puffy Glitter

Admirez et touchez la texture colorée à paillettes !

Glow in the dark

Faites briller votre marque, même dans le noir !

DE> Unsere digitalen Oberflächen & Texturen bei BIC®-Feuerzeugen

Digital Brilliant / Digital Matt

Glänzend oder matt? Wählen Sie die Oberfläche, die Ihnen gefällt!

Metallic

Kreieren Sie großartige Effekte! Metalleffekte bei Texten, Bildern und Hintergründen

Holographic Gold / Holographic Silver

Heben Sie sich von der Masse ab! Spielen Sie mit den attraktiven Lichtreflexen der holographischen Oberfläche.

Puffy Printing

Seien Sie originell! Heben Sie Ihre Marke hervor mit unserer "Puffy"-Tinte und verleihen Sie Ihrem Logo einen Reliefeffekt.

UV Printing

Heben Sie Ihre Marke mit einer Hochglanzoberfläche heraus! Kombinieren Sie matte & glänzende Oberflächen, um Kontraste zu betonen und prominent auf mattem Untergrund hervorzutreten

Sandy

Kreieren Sie einen Sandpapier-Effekt mit körniger Struktur.

Puffy Glitter

Fühlen und sehen Sie die farbige Glitzer-Struktur!

Glow in the dark

Lassen Sie Ihre Marke selbst in der Dunkelheit aufleuchten!

ES> Nuestros acabados digitales y texturas en los encendedores BIC®

Digital Brilliant / Digital matt

¿Brillante o mate? ¡Escoge el acabado que más te guste!

Metallic

¡Crea magníficos efectos! Efectos metálicos en los textos, imágenes y fondos.

Holographic gold / Holographic silver

¡Destaca entre la multitud! Juega con atractivos reflejos de luz con el acabado holográfico.

Puffy printing

¡Sé original! Destaca tu marca con nuestra tinta "puffy" para dar efecto relieve a tu logo.

UV printing

¡Destaca tu marca con el acabado de relieve brillante! Combina mate y brillante para resaltar contrastes y destacar prominentemente en fondo mate.

Sandy

Crea un efecto arena con una textura granulada.

Puffy Glitter

Mira y siente la textura brillante coloreada!

Glow in the dark

¡Haz que tu logo brille incluso en la oscuridad!

IT> Le nostre finiture digitali e le texture degli accendini BIC®

Digital Brilliant / Digital matt

Brillante o opaco? Scegli la finitura che preferisci!

Metallic

Crea effetti incredibili! Effetti metallici su testi, immagini e sfondi.

Holographic gold / Holographic silver

Fatti notare! Gioca con gli attraenti riflessi di luce della finitura olografica.

Puffy printing

Sii originale! Metti in evidenza il tuo marchio con il nostro inchiostro "puffy" per dare un effetto rilievo al tuo logo.

UV printing

Metti in evidenza il tuo marchio con una finitura ultra lucida! Combina una finitura opaca con una lucida per creare contrasti e dare risalto su uno sfondo opaco.

Sandy

Crea un effetto carta vetrata con una texture granulata.

Puffy Glitter

La texture in glitter colorati è tutta da vedere e sentire!

Glow in the dark

Fai brillare il tuo marchio al buio!

Digital finishes & textures



DIGITAL BRILLIANT DIGITAL MATT

Brilliant or matt?

Choose the finish you like!



METALLIC

Create great effects!
Metallic effects in texts, images and backgrounds.



HOLOGRAPHIC GOLD HOLOGRAPHIC SILVER

Stand out from the crowd!
Play with nice **light colour reflections** using the holographic finish.



PUFFY PRINTING

Be original! Highlight your brand with our **"Puffy" ink** to give a relief effect to your logo.



UV PRINTING

Highlight your brand with a high gloss finish! Combine a matt & gloss finish to highlight contrasts and stand out prominently on a **matt background**.



SANDY

Create a **sandpaper effect** with a granulated texture.



PUFFY GLITTER

Feel & see the coloured **glitter texture!**



GLOW IN THE DARK

Make your brand **glow even in the dark**



Lighters

The iconic, well-loved and time-honoured shapes of BIC® pocket lighters remain on trend! Five sizes, two ignition systems, one brand and a wide range of colour combinations.

FR > Le célèbre briquet BIC®, une icône indémodable, avec un design toujours tendance! 5 tailles différentes et une vaste gamme de combinaisons de couleurs.

DE > Das kultige, beliebte und bewährte Design des BIC®-Feuerzeugs liegt weiter im Trend! 5 verschiedene Größen und eine breite Farbkombinationspalette.

ES > El diseño icónico, querido y atemporal del encendedor BIC® sigue siendo tendencia! 5 tamaños distintos y una amplia gama de combinación de colores.

IT > L'iconico, amato e intramontabile design dell'accendino BIC® resta di tendenza! 5 diverse grandezze e una vasta gamma di combinazioni di colori.



LIGHTERS
BIC® LIGHTERS



BIC® J25 Lighter



2360



01

57

57



57

57

Available in **britePix**™ / Disponible en britePix™ / Disponible en britePix™ / Mit BritePix™ erhältlich / Disponibile in britePix™

BIC® LIGHTERS

LIGHTERS



8G

03

59

24

25

25

02

02

Available in **britePix**™ / Disponible en britePix™ / Disponible en britePix™ / Mit BritePix™ erhältlich / Disponibile in britePix™

New!

PASTEL - 2360



90

84

85

83



GOLD HOOD
2430



02

ALL BLACK
2364



02



Available in **britePix**™ / Disponible en britePix™ / Disponible en britePix™ / Mit BritePix™ erhältlich / Disponibile in britePix™

Available in **britePix**™ / Disponible en britePix™ / Disponible en britePix™ / Mit BritePix™ erhältlich / Disponibile in britePix™

*48h not available in Digital finishes / *48h not available in Digital finishes / *48h not available in Digital finishes / *48h not available in Digital finishes / *48h not available in Digital finishes

MOQ 300v.

Decoration:

Personnalisation / Personalización / Dekoration / Decorazione

BIC® J25 Lighter

2360/2364/2430

A/C SP: max. 4 col.

BIC® J25 Lighter britePix™

2360/2364/2430

A/C BP: full-colour

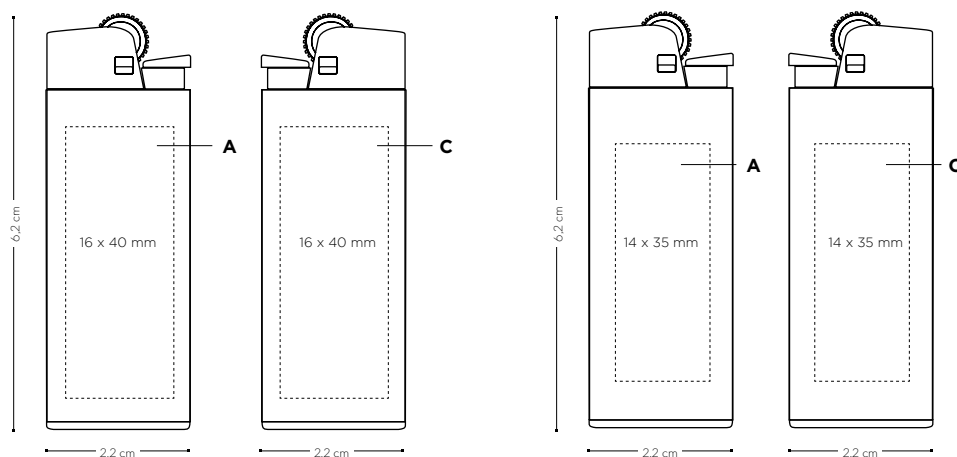

Price (€)

BIC® J25 Lighter	300-599	600-1199	1200-2499	3000-5099	5100-10199	10200-25199	25200-50099
2360							
SP	1,17	1,09	1,03	1,00	0,98	0,95	0,85
BP	1,40	1,30	1,23	1,19	1,16	1,11	1,01
2364							
SP	1,34	1,30	1,22	1,14	1,08	1,05	0,98
BP	1,57	1,51	1,42	1,33	1,26	1,21	1,14
2430							
SP	1,56	1,45	1,37	1,33	1,30	1,26	1,13
BP	1,79	1,66	1,57	1,52	1,48	1,42	1,29

ADDITIONAL IMPRINT CHARGE PER COLOUR & POSITION frais d'impression supplémentaires par couleur et position / cargo por impresión adicional por color y posición / zusätzliche druckkosten pro farbe & position / costo marchio aggiuntivo per colore e posizione.

SP	0,13	0,13	0,13	0,13	0,09	0,09	0,09
BP	0,23	0,21	0,20	0,19	0,18	0,16	0,16

Prices include 1 colour screenprint in one position. Les prix incluent la sérigraphie 1 couleur sur un emplacement. En precio incluye un color en serigrafía en una posición. In den Preisen inbegriffen ist 1 Siebdruck-Farbaufdruck auf 1 Position. I prezzi includono 1 colore a serigrafia in una posizione.

Prices include britePix™ imprint on body. Les prix incluent l'impression britePix™ sur le corps. Los precios incluyen impresión en britePix™ en el cuerpo. BritePix™-Aufdruck auf dem Körper in den Preisen inbegriffen. I prezzi includono la stampa britePix™ sul fusto.

Up to 1400



Packaging:

emballage / envasado / verpackung / imballaggio



Standard Packaging: in tray of 50 u

Printing techniques:

Techniques d'impression / Técnicas de impresión / Drucktechniken / Tecniche di stampa



(SP) SCREEN PRINTING



(BP) britePix™



External packaging:

Emballage externe / Envasado exterior / Außenverpackung / Imballaggio esterno



300 ± 3,8 Kg



Pastel
MADE IN
FRANCE



MADE IN
EUROPE

Digital Printing!

BIC® J25 Digital Lighter
2360

BR PUFFY

MATT PUFFY

MATT M

360°

100%



BR PUFFY



MATT PUFFY



MATT PUFFY



BR



MATT UV

MOQ 600u.

Decoration:

Personnalisation / Personalización / Dekoration / Decorazione

BIC® J25 Digital Lighter

2360

A DG: full-colour

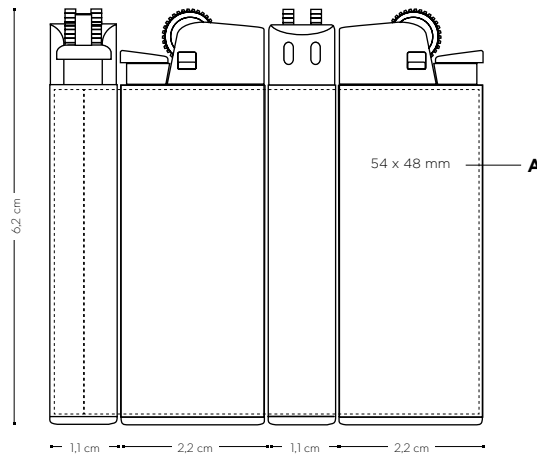

BIC® J25 Digital Lighter 2360	Price (€)					
DG	600-1199	1200-2499	3000-5099	5100-10199	10200-25199	25200-50099
	1,62	1,52	1,44	1,35	1,32	1,23

ADDITIONAL CHARGE DIGITAL FINISHES finitions numériques - coût supplémentaire. cargo adicional acabados digitales. aufpreis digitale ausführungen. costi aggiuntivi per finiture digitali.

							MOQ	
BR MATT	Brilliant or Matt						Free	600 u.
H	Holographic						0,26 0,26 0,26 0,18 0,18 0,18	600 u.
PUFFY	Puffy printing						- - - 0,18 0,18 0,18	5100 u.
M	Metallic						①	50.000 u.
UV	UV						- - - 0,18 0,18 0,18	5100 u.
SA	Sandy						- - - 0,18 0,18 0,18	5100 u.
PUFFY GLOW	Puffy Glitter						- - - 0,18 0,18 0,18	5100 u.
GLOW	Glow in the dark						- - - 0,18 0,18 0,18	5100 u.

Prices include digital imprint on body. Les prix incluent l'impression numérique sur le corps. Los precios incluyen impresión digital en el cuerpo. Digital-Aufdruck auf dem Körper in den Preisen inbegriffen. I prezzi includono la stampa digitale sul fusto.

① Price under request. Prix sur demande. Precio bajo consulta. Preis auf Anfrage. Prezzi su richiesta.

Up to 1400



Packaging:

emballage / envasado / verpackung / imballaggio



Standard Packaging: in tray of 50 u

Printing techniques:

Techniques d'impression / Técnicas de impresión / Drucktechniken / Tecniche di stampa



(DG) DIGITAL

External packaging:

Emballage externe / Envasado exterior / Außenverpackung / Imballaggio esterno



600 ± 7,6 Kg



MADE IN SPAIN

LIGHTERS
BIC® LIGHTERS

BIC J23 Lighter



Slim & fits everywhere!

New Colour!

New Colour!

2340



57

12

10

03

59

05

New Colour!



24

04

25

02

FR > Compact, il se glisse partout !

ES > ¡Fino y que adapta a cualquier lugar!

DE > Schlank! Passt überall!

IT > Sottile, lo infili ovunque!

*48h not available in Digital finishes / *48h not available in Digital finishes / *48h not available in Digital finishes / *48h not available in Digital finishes / *48h not available in Digital finishes



MOQ 300v.

Decoration:

Personnalisation / Personalización / Dekoration / Decorazione

BIC® J23 Lighter

2340

A/C SP: max. 4 col.

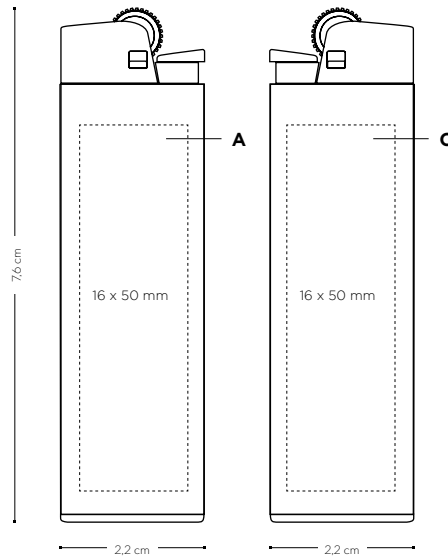

	Price (€)						
BIC® J23 Lighter	300-599	600-1199	1200-2499	3000-5099	5100-10199	10200-25199	25200-50099
2340							
SP	1.29	1.23	1.16	1.09	1.06	1.03	0.97

ADDITIONAL IMPRINT CHARGE PER COLOUR & POSITION frais d'impression supplémentaires par couleur et position / cargo por impresión adicional por color y posición / zusätzliche druckkosten pro farbe & position / costo marchio aggiuntivo per colore e posizione.

SP	0,13	0,13	0,13	0,13	0,09	0,09	0,09
-----------	------	------	------	------	------	------	------

Prices include 1 colour screenprint in one position. Les prix incluent la sérigraphie 1 couleur sur un emplacement. En precio incluye un color en serigrafía en una posición. In den Preisen inbegriffen ist 1 Siebdruck-Farbaufdruck auf 1 Position. I prezzi includono 1 colore a serigrafia in una posizione.

LIGHTERS
BIC® LIGHTERS

Up to 1800



Packaging:

emballage / envasado / verpackung / imballaggio



Standard Packaging: in tray of 50 u

Printing techniques:

Techniques d'impression / Técnicas de impresión / Drucktechniken / Tecniche di stampa



(SP) SCREEN PRINTING



(DG) DIGITAL

External packaging:

Emballage externe / Envasado exterior / Außenverpackung / Imballaggio esterno



600 ± 9,5 Kg



MADE IN FRANCE



BIC J23 Lighter



MATT M

Digital Printing!

BIC® J23 Digital Lighter
2340

360°

100%

BR PUFFY



MATT PUFFY UV

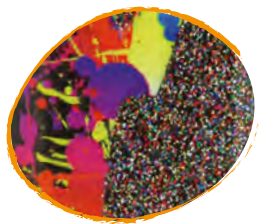

BR PUFFY SUMMER



BR

BIC® LIGHTERS
LIGHTERS

MOQ 600u.

Decoration:

Personnalisation / Personalización / Dekoration / Decorazione

BIC® J23 Digital Lighter

2340

A DG: full-colour

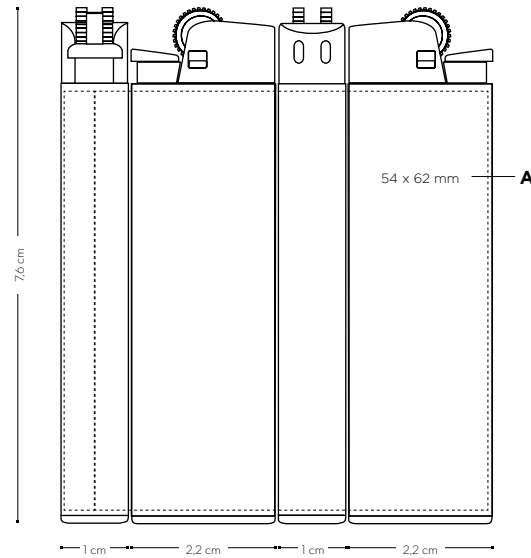

LIGHTERS
BIC® LIGHTERS

	Price (€)					
BIC® J23 Digital Lighter 2340	600-1199	1200-2499	3000-5099	5100-10199	10200-25199	25200-50099
DG	1,77	1,67	1,58	1,50	1,43	1,33

ADDITIONAL CHARGE DIGITAL FINISHES finitions numériques - coût supplémentaire. cargo adicional acabados digitales. aufpreis digitale ausföhrungen. costi aggiuntivi per finiture digitali.

							MOQ	
BR MATT	Brilliant or Matt						Free	600 u.
H	Holographic						0,26 0,26 0,26 0,18 0,18 0,18	600 u.
PUFFY	Puffy printing						- - - 0,18 0,18 0,18	5100 u.
M	Metallic						①	50.000 u.
UV	UV						- - - 0,18 0,18 0,18	5100 u.
SA	Sandy						- - - 0,18 0,18 0,18	5100 u.
PUFFY GLITTER	Puffy Glitter						- - - 0,18 0,18 0,18	5100 u.
GLOW	Glow in the dark						- - - 0,18 0,18 0,18	5100 u.

Prices include digital imprint on body. Les prix incluent l'impression numérique sur le corps. Los precios incluyen impresión digital en el cuerpo. Digital-Aufdruck auf dem Körper in den Preisen inbegriffen. I prezzi includono la stampa digitale sul fusto.

① Price under request. Prix sur demande. Precio bajo consulta. Preis auf Anfrage. Prezzi su richiesta.



J26 Lighter



Extra long-lasting: up to 3.000 lights!

2320



01

57

8G

10

03

New colour!



59

24



25

02

FR > Longue durée jusqu'à 3 000 allumages

ES > Extra duración i hasta 3.000 encendidos!

DE > Extra ausdauernd Bis zu 3.000 Zündungen!

IT > Durata extra lunga fino a 3.000 accensioni!

*48h not available in Digital finishes / *48h not available in Digital finishes / *48h not available in Digital finishes / *48h not available in Digital finishes / *48h not available in Digital finishes



MOQ 3000.

Decoration:

Personnalisation / Personalización / Dekoration / Decorazione

BIC® J26 Lighter

2320

A/C SP: max. 4 col.

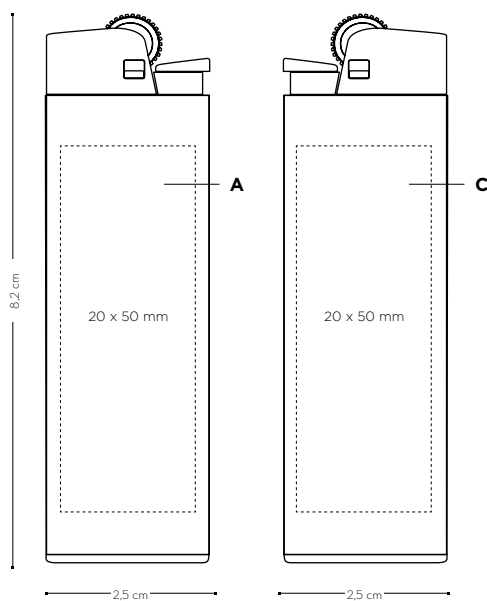

	Price (€)						
BIC® J26 Lighter	300-599	600-1199	1200-2499	3000-5099	5100-10199	10200-25199	25200-50099
2320							
SP	1,52	1,41	1,33	1,27	1,20	1,17	1,09

ADDITIONAL IMPRINT CHARGE PER COLOUR & POSITION frais d'impression supplémentaires par couleur et position / cargo por impresión adicional por color y posición / zusätzliche druckkosten pro farbe & position / costo marchio aggiuntivo per colore e posizione.

SP	0,13	0,13	0,13	0,13	0,09	0,09	0,09
-----------	------	------	------	------	------	------	------

Prices include 1 colour screenprint in one position. Les prix incluent la sérigraphie 1 couleur sur un emplacement. En precio incluye un color en serigrafía en una posición. In den Preisen inbegriffen ist 1 Siebdruck-Farbaufdruck auf 1 Position. I prezzi includono 1 colore a serigrafia in una posizione.

Up to 3000



Packaging:

emballage / envasado / verpackung / imballaggio



Standard Packaging: in tray of 50 u

Printing techniques:

Techniques d'impression / Técnicas de impresión / Drucktechniken / Tecniche di stampa



(SP) SCREEN PRINTING



(DG) DIGITAL

External packaging:

Emballage externe / Envasado exterior / Außenverpackung / Imballaggio esterno



600 ± 15,1 Kg



MADE IN SPAIN

LIGHTERS
BIC® LIGHTERS

Digital Printing!

BIC® J26 Digital Lighter
2320

360°

100%

MATT M PUFFY

BR M

BR H



MATT M PUFFY



BR M



MATT



MATT UV



MATT M

MOQ 600u.

Decoration:

Personnalisation / Personalización / Dekoration / Decorazione

BIC® J26 Digital Lighter

2320

A DG: full-colour

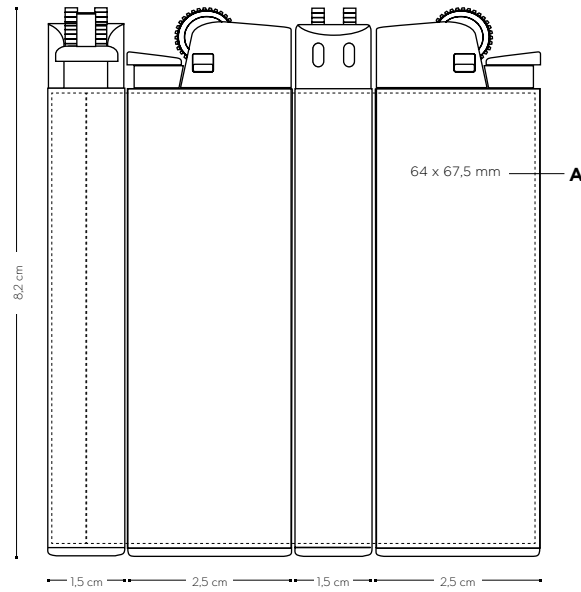

Price (€)

BIC® J26 Digital Lighter	600-1199	1200-2499	3000-5099	5100-10199	10200-25199	25200-50099
2320						
DG	2,06	1,95	1,84	1,72	1,68	1,58

ADDITIONAL CHARGE DIGITAL FINISHES finitions numériques - coût supplémentaire. cargo adicional acabados digitales. aufpreis digitale ausföhrungen. costi aggiuntivi per finiture digitali.

							MOQ	
BR MATT	Brilliant or Matt						Free	600 u.
H	Holographic						0,26 0,26 0,26 0,18 0,18 0,18	600 u.
PUFFY	Puffy printing						- - - 0,18 0,18 0,18	5100 u.
M	Metallic						①	50.000 u.
UV	UV						- - - 0,18 0,18 0,18	5100 u.
SA	Sandy						- - - 0,18 0,18 0,18	5100 u.
PUFFY GLITTER	Puffy Glitter						- - - 0,18 0,18 0,18	5100 u.
GLOW	Glow in the dark						- - - 0,18 0,18 0,18	5100 u.

Prices include digital imprint on body. Les prix incluent l'impression numérique sur le corps. Los precios incluyen impresión digital en el cuerpo. Digital-Aufdruck auf dem Körper in den Preisen inbegriffen. I prezzi includono la stampa digitale sul fusto.

① Price under request. Prix sur demande. Precio bajo consulta. Preis auf Anfrage. Prezzi su richiesta.

J38 Lighter



Elegant and comfortable lighting!

STANDARD - 2452

GOLD HOOD - 2451

BIC® LIGHTERS

LIGHTERS



57



57



57



03

100%



25



02



02

FR > Allumage élégant et pratique !

ES > ¡Encendido elegante y cómodo!

DE > Elegantes und komfortables Zünden!

IT > Elegante e comodo!



*48h not available in Digital finishes / *48h not available in Digital finishes / *48h not available in Digital finishes / *48h not available in Digital finishes / *48h not available in Digital finishes



280 www.bicgraphic.eu

MOQ 300v.

Decoration:

Personnalisation / Personalización / Dekoration / Decorazione

BIC® J38 Lighter

2452/2451

A/B SP: max. 4 col.

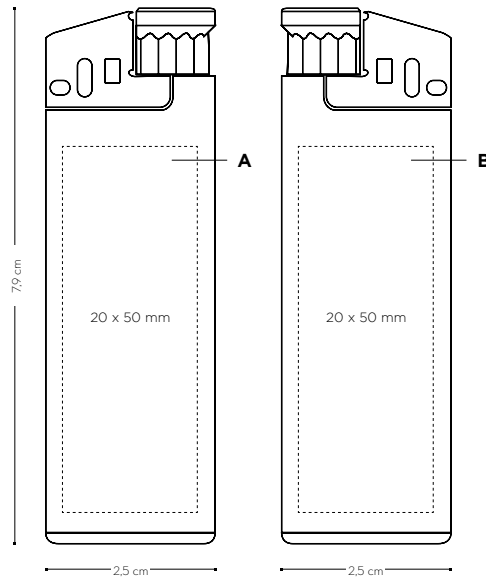

	Price (€)						
BIC® J38 Lighter	300-599	600-1199	1200-2499	3000-5099	5100-10199	10200-25199	25200-50099
2452							
SP	1,88	1,79	1,71	1,63	1,55	1,49	1,38
2451							
SP	2,27	2,17	2,07	1,97	1,88	1,82	1,69

ADDITIONAL IMPRINT CHARGE PER COLOUR & POSITION frais d'impression supplémentaires par couleur et position / cargo por impresión adicional por color y posición / zusätzliche druckkosten pro farbe & position / costo marchio aggiuntivo per colore e posizione.

SP	0,13	0,13	0,13	0,13	0,09	0,09	0,09
-----------	------	------	------	------	------	------	------

Prices include 1 colour screenprint in one position. Les prix incluent la sérigraphie 1 couleur sur un emplacement. En precio incluye un color en serigrafía en una posición. In den Preisen inbegriffen ist 1 Siebdruck-Farbaufdruck auf 1 Position. I prezzi includono 1 colore a serigrafia in una posizione.

LIGHTERS
BIC® LIGHTERS

Up to 1800



Packaging:

emballage / envasado / verpackung / imballaggio



Standard Packaging: in tray of 50 u

Printing techniques:

Techniques d'impression / Técnicas de impresión / Drucktechniken / Tecniche di stampa



(SP) SCREEN PRINTING



(DG) DIGITAL

External packaging:

Emballage externe / Envasado exterior / Außenverpackung / Imballaggio esterno



600 ± 13,2 Kg



MADE IN SPAIN



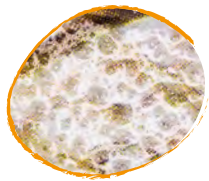

BR SA

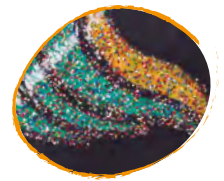

BR PUFFY GLITTER



Digital Printing!

BIC® J38 Lighter Digital
STANDARD - 2452



57



57 BR

360°

100%



57



BR GLOW

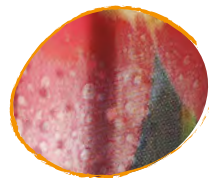

MATT M

BIC® LIGHTERS
LIGHTERS

MOQ 600u.

Decoration:

Personnalisation / Personalización / Dekoration / Decorazione

BIC® J38 Digital Lighter

2452

A DG: full-colour

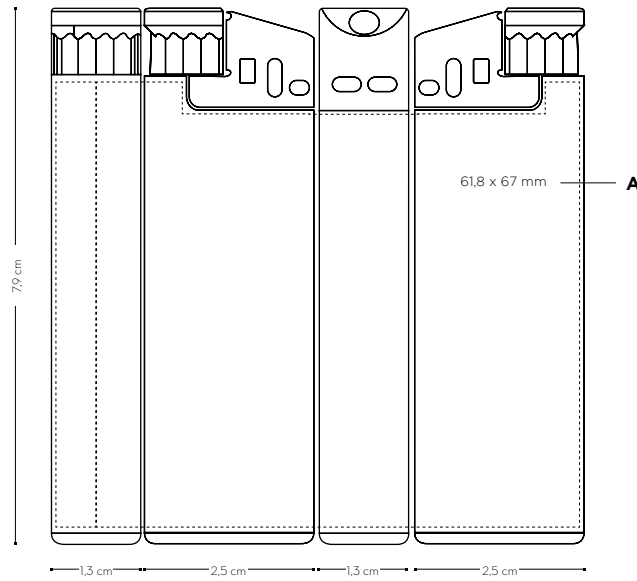

Price (€)

BIC® J38 Digital Lighter	300-599	600-1199	1200-2499	3000-5099	5100-10199	10200-25199	25200-50099
2452							
DG	-	2,06	1,95	1,84	1,72	1,68	1,58

ADDITIONAL CHARGE DIGITAL FINISHES finitions numériques - coût supplémentaire. cargo adicional acabados digitales. aufpreis digitale ausföhrungen. costi aggiuntivi per finiture digitali.

	Price (€)							MOQ
BR MATT	Free							600 u.
H	-	0,26	0,26	0,26	0,18	0,18	0,18	600 u.
PUFFY	-	-	-	-	0,18	0,18	0,18	5100 u.
M	①							50.000 u.
UV	-	-	-	-	0,18	0,18	0,18	5100 u.
SA	-	-	-	-	0,18	0,18	0,18	5100 u.
PUFFY GLITTER	-	-	-	-	0,18	0,18	0,18	5100 u.
GLOW	-	-	-	-	0,18	0,18	0,18	5100 u.

Prices include digital imprint on body. Les prix incluent l'impression numérique sur le corps. Los precios incluyen impresión digital en el cuerpo. Digital-Aufdruck auf dem Körper in den Preisen inbegriffen. I prezzi includono la stampa digitale sul fusto.

① Price under request. Prix sur demande. Precio bajo consulta. Preis auf Anfrage. Prezzi su richiesta.

J39 Lighter



Convenient mini size!

STANDARD - 2479



BIC® LIGHTERS
LIGHTERS

FR > Taille mini et pratique !

ES > Práctico tamaño pequeño!

DE > Praktisches Miniformat!

IT > Pratico formato mini!

*48h not available in Digital finishes / *48h not available in Digital finishes / *48h not available in Digital finishes / *48h not available in Digital finishes / *48h not available in Digital finishes



MOQ 300v.

Decoration:

Personnalisation / Personalización / Dekoration / Decorazione

BIC® J39 Lighter

2479

A/B SP: max. 4 col.

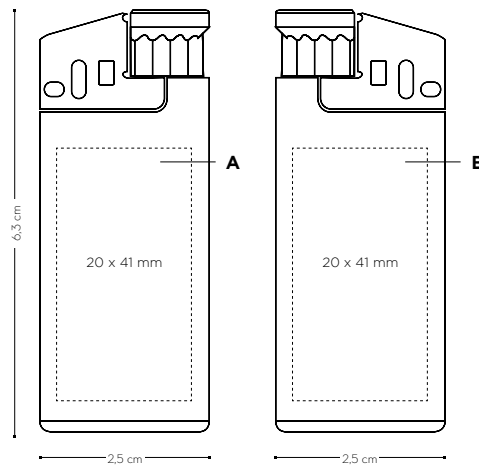

	Price (€)						
BIC® J39 Lighter	300-599	600-1199	1200-2499	3000-5099	5100-10199	10200-25199	25200-50099
2479							
SP	1,87	1,77	1,70	1,62	1,54	1,48	1,37

ADDITIONAL IMPRINT CHARGE PER COLOUR & POSITION frais d'impression supplémentaires par couleur et position / cargo por impresión adicional por color y posición / zusätzliche druckkosten pro farbe & position / costo marchio aggiuntivo per colore e posizione.

SP	0,13	0,13	0,13	0,13	0,09	0,09	0,09
-----------	------	------	------	------	------	------	------

Prices include 1 colour screenprint in one position. Les prix incluent la sérigraphie 1 couleur sur un emplacement. En precio incluye un color en serigrafía en una posición. In den Preisen inbegriffen ist 1 Siebdruck-Farbaufdruck auf 1 Position. I prezzi includono 1 colore a serigrafia in una posizione.

LIGHTERS
BIC® LIGHTERS

Up to 1050



Packaging:

emballage / envasado / verpackung / imballaggio



Standard Packaging: in tray of 50 u

Printing techniques:

Techniques d'impression / Técnicas de impresión / Drucktechniken / Tecniche di stampa



(SP) SCREEN PRINTING



(DG) DIGITAL

External packaging:

Emballage externe / Envasado exterior / Außenverpackung / Imballaggio esterno



600 ± 11,1 Kg



MADE IN SPAIN





MATT SA



MATT M



BIC® LIGHTERS
LIGHTERS

Digital Printing!

BIC® J39 Lighter Digital
STANDARD - 2479

57

360°

100%

57

03 BR



BR



BR GLOW

MOQ 600u.

Decoration:

Personnalisation / Personalización / Dekoration / Decorazione

BIC® J39 Digital Lighter

2479

A DG: full-colour

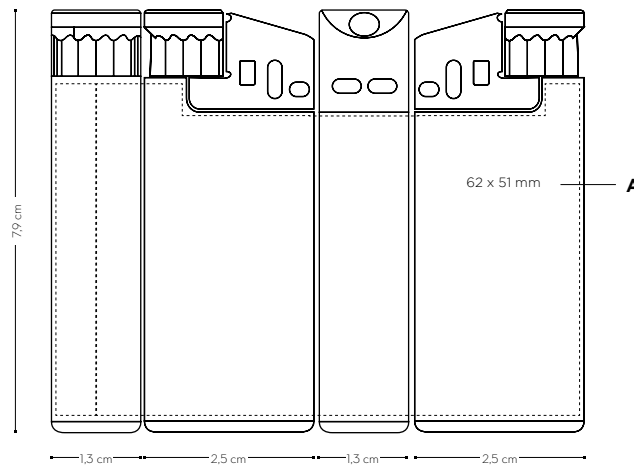

LIGHTERS
BIC® LIGHTERS

	Price (€)						
BIC® J39 Digital Lighter 2479	300-599	600-1199	1200-2499	3000-5099	5100-10199	10200-25199	25200-50099
DG	-	2,00	1,91	1,82	1,73	1,68	1,56

	ADDITIONAL CHARGE DIGITAL FINISHES finitions numériques - coût supplémentaire. cargo adicional acabados digitales. aufpreis digitale ausführungen. costi aggiuntivi per finiture digitali.							MOQ
BR MATT Brilliant or Matt	Free							600 u.
H Holographic	-	0,26	0,26	0,26	0,18	0,18	0,18	600 u.
PUFFY Puffy printing	-	-	-	-	0,18	0,18	0,18	5.100 u.
M Metallic	①							50.000 u.
UV UV	-	-	-	-	0,18	0,18	0,18	5.100 u.
SA Sandy	-	-	-	-	0,18	0,18	0,18	5.100 u.
PUFFY GLITTER Puffy Glitter	-	-	-	-	0,18	0,18	0,18	5.100 u.
GLOW Glow in the dark	-	-	-	-	0,18	0,18	0,18	5.100 u.

Prices include digital imprint on body. Les prix incluent l'impression numérique sur le corps. Los precios incluyen impresión digital en el cuerpo. Digital-Aufdruck auf dem Körper in den Preisen inbegriffen. I prezzi includono la stampa digitale sul fusto.

① Price under request. Prix sur demande. Precio bajo consulta. Preis auf Anfrage. Prezzi su richiesta.



BIC® Mega Lighter

BIC® LIGHTERS

LIGHTERS



Comes in an individual box!
Customise it from 2.500 units



2500

100%

FR > Simple et pratique à utiliser grâce à sa tige de 6 cm.
Proposé en emballage individuel!
Personnalisez-le à partir de 2500 unités.

ES > Fácil y cómodo de encender gracias a sus 6cm de varilla.
¡Viene en una caja individual!
Personalizable a partir de 2500 unidades

DE > Einfach und komfortabel zu zünden, dank 6-cm-Stab
Wird in Einzelbox geliefert! Anpassung an Kundenwünsche ab 2.500 Stück möglich

IT > Rende l'accensione facile e pratica grazie all'asta di 6 cm
Proposto in confezione singola!
Personalizzalo a partire da 2500 unità



MOQ 100v.

Decoration:

Personnalisation / Personalización / Dekoration / Decorazione

BIC® Mega Lighter
2500

A PD: max. 2 col.

B PD: max. 2 col.

B BP: full-colour

BP Texture: full-colour

C DG: full-colour

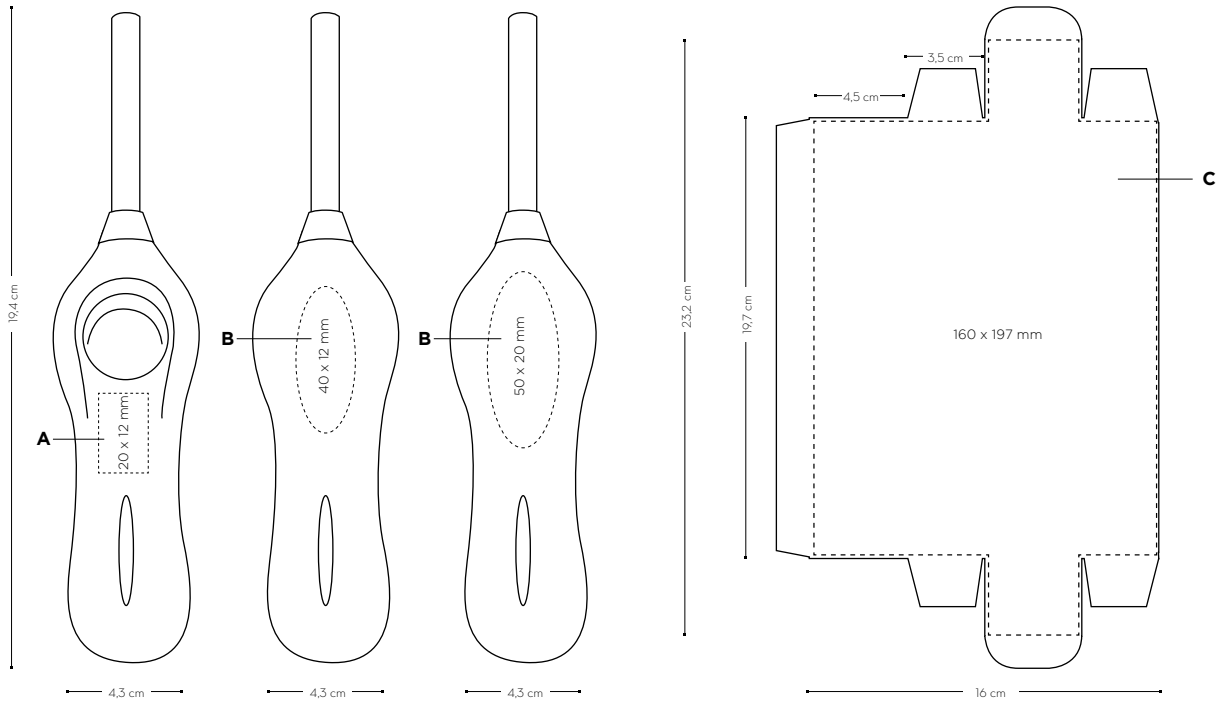

Price (€)

BIC® Mega Lighter 2500	100-249	300-599	600-1499	1200-2499	3000-5099	5100-10199	10200-25199
PD	5.81	5.55	5.27	4.98	4.78	4.64	4.51
BP	6.40	6.10	5.80	5.53	5.26	5.11	4.97

ADDITIONAL IMPRINT CHARGE PER COLOUR & POSITION frais d'impression supplémentaires par couleur et position / cargo por impresión adicional por color y posición / zusätzliche druckkosten pro farbe & position / costo marchio aggiuntivo per colore e posizione.

PD	0.50	0.48	0.46	0.43	0.43	0.43	0.43
BP Texture	1.19	1.15	1.11	1.07	1.06	1.06	1.06

Prices include 1 colour padprint in one position. Les prix incluent la tampographie monochrome sur un emplacement. Los precios incluyen una color en tampografía en una posición. In den Preisen inbegriffen ist ein Tampondruck-Aufdruck auf einer Position. I prezzi includono 1 colore con stampa a tampone in una posizione.

Prices include britePix™ imprint on body. Les prix incluent l'impression britePix™ sur le corps. Los precios incluyen impresión en britePix™ en el cuerpo. BritePix™-Aufdruck auf dem Körper in den Preisen inbegriffen. I prezzi includono la stampa britePix™ sul fusto.

ADDITIONAL CHARGE FOR CUSTOMER LOGO PRINTED ON THE BOX (from 2.500 u.)

DG	-	-	-	0.84	0.69	0.49	0.29
-----------	---	---	---	------	------	------	------

Prices include fully personalised packaging in 4-colour process. Le prix inclut l'emballage totalement personnalisé en quadrichromie / Los precios incluyen un envasado totalmente personalizado en cuatricromía / In den Preisen sind mit Vierfarbdruck voll personalisierte Verpackungen inbegriffen / I prezzi includono imballaggi completamente personalizzati in quadricromia.

Up to 750

Conform
ISO 22702

Packaging:

emballage / envasado /
verpackung / imballaggio



Standard packaging:
individual carton box

Printing techniques:

Techniques d'impression / Técnicas de impresión /
Drucktechniken / Tecniche di stampa



(PD) PAD
PRINTING



(BP) britePix™



(DG) DIGITAL



External packaging:

Emballage externe / Envasado exterior /
Außenverpackung / Imballaggio esterno



100 ± 8,3 Kg

LIGHTERS
BIC® LIGHTERS

BIC® stylit Luxury case

2386

NEON - 2386



MOQ 100v.

Decoration:

Personalisation / Personalización /
Dekoration / Decorazione

BIC® stylit Luxury case
2386

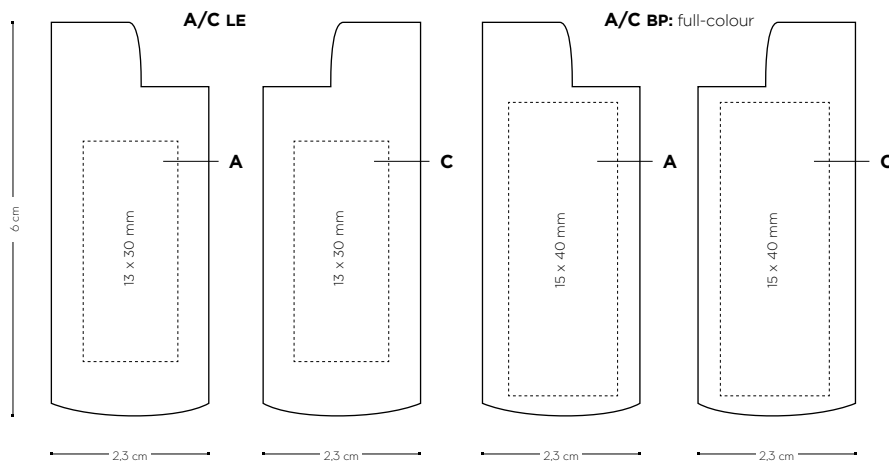

Price (€)

BIC® stylit Luxury case	100-249	300-599	600-1499	1200-2499	3000-5099	5100-10999	10200-25999
2386							
LE	4,31	4,11	3,85	3,72	①	①	①
BP (not available for Neon colours)	3,35	3,24	3,09	2,95	①	①	①

ADDITIONAL IMPRINT CHARGE PER COLOUR & POSITION frais d'impression supplémentaires par couleur et position / cargo por impresión adicional por color y posición / zusätzliche druckkosten pro farbe & position / costo marchio aggiuntivo per colore e posizione.

LE	1,21	1,09	0,96	0,96	①	①	①
BP (not available for Neon colours)	0,25	0,22	0,20	0,19	①	①	①

Prices include one imprint in one position according to specified technique. Les prix incluent une impression sur un emplacement avec la technique spécifiée / Los precios incluyen una impresión en una posición acorde con la técnica especificada / In den Preisen inbegriffen ist ein Aufdruck auf einer Position gemäß angegebener Technik / I prezzi includono una stampa in una posizione a seconda della tecnica specificata.

① Price under request. Prix sur demande. Precio bajo consulta. Preis auf Anfrage. Prezzi su richiesta.



Packaging:

emballage / envasado /
verpackung / imballaggio



Standard Packaging: box for 10 units

Printing techniques:

Techniques d'impression / Técnicas de impresión /
Drucktechniken / Tecniche di stampa



(LE) LASER



(BP) britePix™



External packaging:

Emballage externe / Envasado exterior /
Außenverpackung / Imballaggio esterno



300 ± 6,1 Kg



SOFT - 2153



01

47

25

METALLIC - 2161



47

34

02

MOQ 100v.

Decoration:

Personnalisation / Personalización / Dekoration / Decorazione

BIC® Stylit Luxury Case
2153/2161
A/C LE

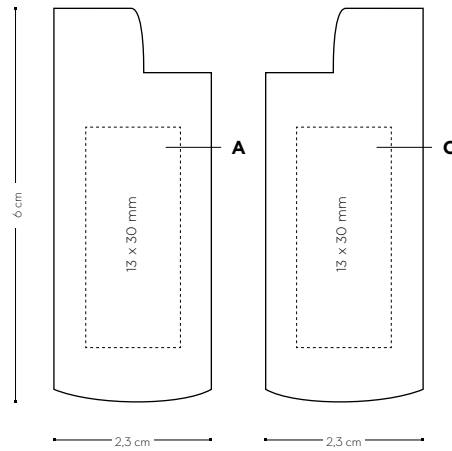

Price (€)

BIC® Stylit Luxury Case	100-249	300-599	600-119	1200-2499	3000-5099	5100-1099	10200-2599
2153							
LE	4,52	4,37	4,18	4,02	①	①	①
2161							
LE	4,83	4,62	4,35	4,20	①	①	①

ADDITIONAL IMPRINT CHARGE PER COLOUR & POSITION frais d'impression supplémentaires par couleur et position / cargo por impresión adicional por color y posición / zusätzliche druckkosten pro farbe & position / costo marchio aggiuntivo per colore e posizione.

LE	1,21	1,09	0,96	0,96	①	①	①
-----------	------	------	------	------	---	---	---

Prices include imprint in 1 position. Le prix inclut 1 impression sur 1 position / Los precios incluyen 1 impresión en una posición / Preise inklusive eines Aufdruckes an einer Position / I prezzo include 1 stampa in 1 posizione.

① Price under request. Prix sur demande. Precio bajo consulta. Preis auf Anfrage. Prezzi su richiesta.

LIGHTER CASES
BIC® LIGHTERS



Packaging:

embalage / envasado / verpackung / imballaggio



Standard Packaging: box for 10 units

Printing techniques:

Techniques d'impression / Técnicas de impresión / Drucktechniken / Tecniche di stampa



(LE) LASER

External packaging:

Emballage externe / Envasado exterior / Außenverpackung / Imballaggio esterno



300 ± 6,1 Kg

BIC® Aluminium Flat Case

3 customisable sides!

2156



01

47

03

07

02

A/B/C LE

A/B/C BP: full-colour

MOQ 1000.

Decoration:

Personnalisation / Personalización /
Dekoration / Decorazione

BIC® Aluminium Flat Case
2156

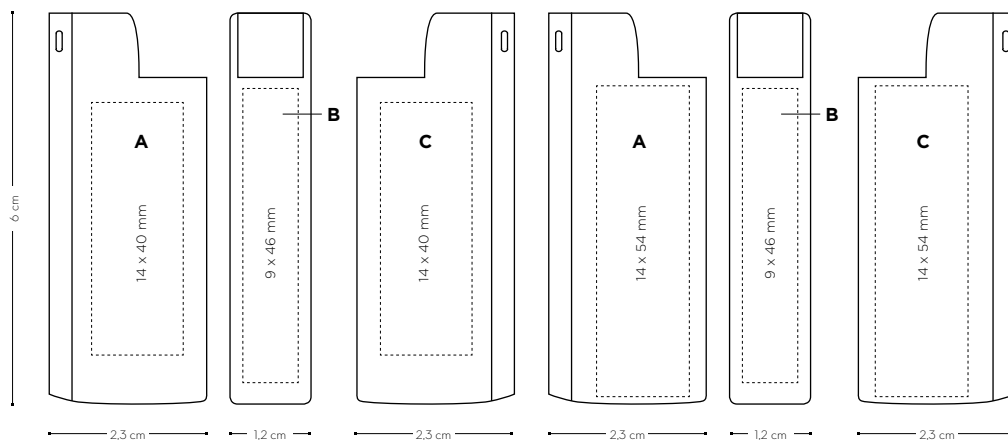

FR > 3 faces personnalisables !

ES > ¡3 caras personalizables!

DE > 3 kundenspezifisch anpassbare
Seiten

IT > 3 lati personalizzabili!

Price (€)

BIC® Aluminium Flat Case	100-299	300-599	600-999	1200-2499	3000-5099	5100-10999	10100-25999
2156							
LE	3,10	2,93	2,71	2,63	①	①	①
BP	2,14	2,06	1,95	1,86	①	①	①

ADDITIONAL IMPRINT CHARGE PER COLOUR & POSITION frais d'impression supplémentaires par couleur et position / cargo por impresión adicional por color y posición / zusätzliche druckkosten pro farbe & position / costo marchio aggiuntivo per colore e posizione.

LE	1,21	1,09	0,96	0,96	①	①	①
BP	0,25	0,22	0,20	0,19	①	①	①

Prices include one imprint in one position according to specified technique. Les prix incluent une impression sur un emplacement avec la technique spécifiée / Los precios incluyen una impresión en una posición acorde con la técnica especificada / In den Preisen inbegriffen ist ein Aufdruck auf einer Position gemäß angegebener Technik / I prezzi includono una stampa in una posizione a seconda della tecnica specificata.

① Price under request. Prix sur demande. Precio bajo consulta. Preis auf Anfrage. Prezzi su richiesta.



Packaging:

emballage / envasado /
verpackung / imballaggio



Standard Packaging: box for 10 units

Printing techniques:

Techniques d'impression / Técnicas de impresión /
Drucktechniken / Tecniche di stampa



(LE) LASER



(BP) britePix™



External packaging:

Emballage externe / Envasado exterior /
Außenverpackung / Imballaggio esterno



300 ± 6,9 Kg

2398



MOQ 1000.

Decoration:

Personnalisation / Personalización / Dekoration / Decorazione

BIC® clip case

2398

A/C BP: full-colour

BP Texture: full-colour

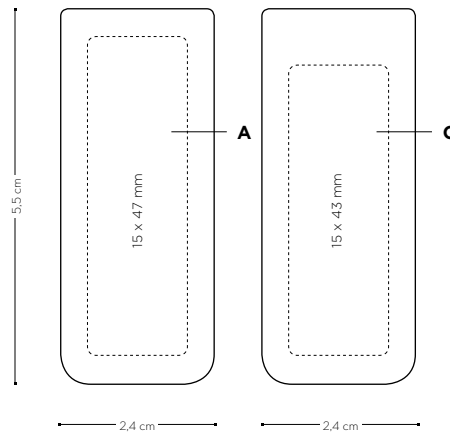

Price (€)

BIC® clip case	100-249	300-599	600-1499	1200-2499	3000-5099	5100-10499	10200-25499
2398							
BP	1,76	1,65	1,52	1,47	①	①	①

ADDITIONAL IMPRINT CHARGE PER COLOUR & POSITION frais d'impression supplémentaires par couleur et position / cargo por impresión adicional por color y posición / zusätzliche druckkosten pro farbe & position / costo marchio aggiuntivo per colore e posizione.

BP	0,25	0,22	0,20	0,19	①	①	①
BP Texture	0,19	0,17	0,15	0,14	①	①	①

britePix™: imprint on body. **britePix™:** impression sur le corps. / **britePix™:** impresión en el cuerpo / **britePix™:** Aufdruck auf Hülle / **britePix™:** stampa sul corpo.

① Price under request. Prix sur demande. Precio bajo consulta. Preis auf Anfrage. Prezzi su richiesta.



Packaging:

emballage / envasado / verpackung / imballaggio



Standard Packaging: box for 50 units

Printing techniques:

Techniques d'impression / Técnicas de impresión / Drucktechniken / Tecniche di stampa



(BP) britePix™



External packaging:

Emballage externe / Envasado exterior / Außenverpackung / Imballaggio esterno



300 ± 7,5 Kg

BIC® styl'it Fashion Case

2390



66

100%

MOQ 1000.

Decoration:

Personalisation / Personalización / Dekoration / Decorazione

BIC® styl'it Fashion Case
2390

A/C PD: max. 1 col.

BP: full-colour

BP Texture: full-colour

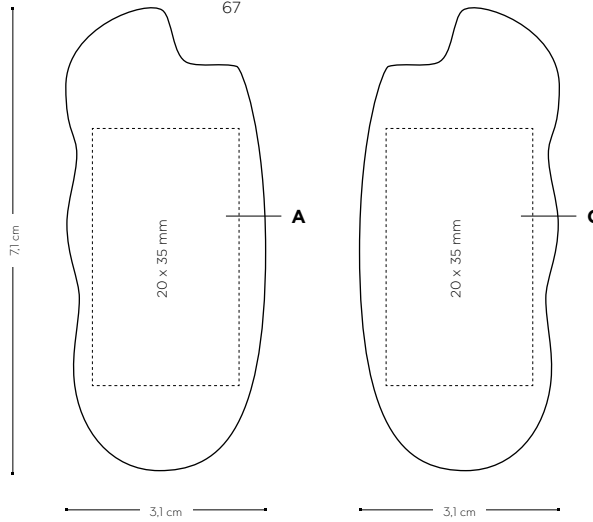

Price (€)

BIC® styl'it Fashion Case	100-249	250-499	500-999	1000-2499	2500-4999	5000-9999	10000-24999
2390							
PD	1,82	1,74	1,64	1,56	①	①	①
BP	2,07	1,96	1,84	1,75	①	①	①

ADDITIONAL IMPRINT CHARGE PER COLOUR & POSITION frais d'impression supplémentaires par couleur et position / cargo por impresión adicional por color y posición / zusätzliche druckkosten pro farbe & position / costo marchio aggiuntivo per colore e posizione.

PD	0,34	0,29	0,21	0,21	①	①	①
BP	0,25	0,22	0,20	0,19	①	①	①
BP Texture	0,19	0,17	0,15	0,14	①	①	①

Prices include one imprint in one position according to specified technique. Les prix incluent une impression sur un emplacement avec la technique spécifiée / Los precios incluyen una impresión en una posición acorde con la técnica especificada / In den Preisen inbegriffen ist ein Aufdruck auf einer Position gemäß angegebener Technik / I prezzi includono una stampa in una posizione a seconda della tecnica specificata.

① Price under request. Prix sur demande. Precio bajo consulta. Preis auf Anfrage. Prezzi su richiesta.



Packaging:

emballage / envasado / verpackung / imballaggio



Standard Packaging: box for 50 units

Printing techniques:

Techniques d'impression / Técnicas de impresión / Drucktechniken / Tecniche di stampa



(PD) PAD PRINTING



(BP) britePix™



External packaging:

Emballage externe / Envasado exterior / Außenverpackung / Imballaggio esterno



300 ± 8,05 Kg



Convert your logo into a 3D shape!

2395



100%

MOQ 1.200v.

Decoration:

Personnalisation / Personalización / Dekoration / Decorazione

BIC® 3D Case

2395

A/C 3D: max. 6 col.

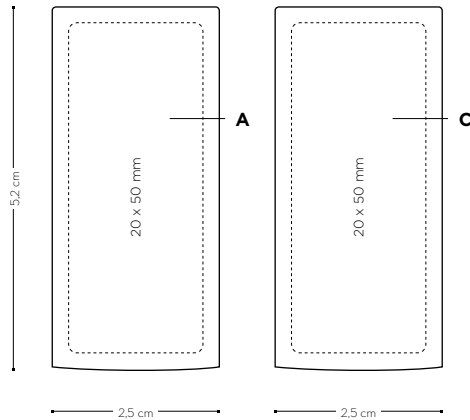

FR > Convertissez votre logo en 3D !
 ES > ¡Convierte tu logo con forma 3D!
 DE > Bringen Sie Ihr Logo in 3-D-Form!

IT > Trasforma il tuo logo in una forma tridimensionale!

BIC® 3D CASE	1200-2499	3000-5099	5100-10999	10200-25999	25200-50099
2395					
3D	4,74	4,49	4,27	①	①

ADDITIONAL IMPRINT CHARGE PER COLOUR & POSITION frais d'impression supplémentaires par couleur et position / cargo por impresión adicional por color y posición / zusätzliche druckkosten pro farbe & position / costo marchio aggiuntivo per colore e posizione.

3D embossing on side B (1 colour)	0,17	0,15	0,15	①	①
Additional embossed colours	0,10	0,09	0,09	①	①

Price includes 3D embossing in 1 colour in 1 position. Le prix inclut le gaufrage 3D en 1 couleur sur 1 emplacement / El precio incluye termograbado 3D em 1 color y una posición / 3D-Prägung in 1 Farbe auf 1 Position im Preis inbegriffen / Il prezzo include stampa a caldo in 3D ad un colore in una posizione.

LIGHTER CASES
BIC® LIGHTERS



Packaging:

emballage / envasado / verpackung / imballaggio



Standard Packaging: box for 50 units

Printing techniques:

Techniques d'impression / Técnicas de impresión / Drucktechniken / Tecniche di stampa



3D EMBOSHING

External packaging:

Emballage externe / Envasado exterior / Außenverpackung / Imballaggio esterno



300 ± 7,5 Kg

Please contact your Customer Service Representative for further details. Pour de plus amples détails, veuillez contacter notre service clients. Para más detalles, por favor contacta con tu representante de atención al cliente. Bitte setzen Sie sich mit Ihrem Customer-Service-Verepreter in Verbindung, um mehr Details zu erfahren. Contatta il tuo rappresentante del servizio clienti per maggiori informazioni.

BIC® Pocket Ashtray

3850

6 different flap shapes available!



Reusable and hermetic

Decoration:

Personnalisation / Personalización / Dekoration / Decorazione

BIC® Pocket Ashtray

MOQ 5.000u.

3850

A SP: max. 5 col.

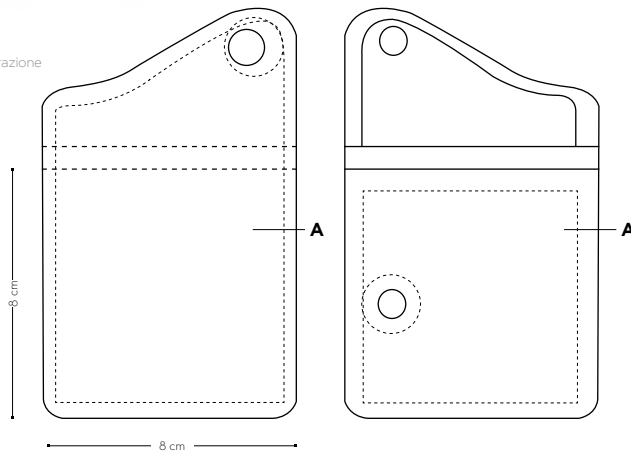

Price (€)

BIC® Pocket Ashtray	5000-9999	10000-19999	20000-24999	25000-49999	50000-74999	75000-9999	>100000
3850							
SP	0,85	0,74	0,67	0,64	①	①	①

Price includes 1 imprint colour and legal text. Le prix inclut l'impression en 1 couleur et le texte légal. Los precios incluyen 1 impresión en 1 color y el texto legal. 1 Aufdruckfarbe und Rechtshinweis im Preis inbegriffen. Il prezzo include la stampa a 1 colore e testo legale.

① Price under request. Prix sur demande. Precio bajo consulta. Preis auf Anfrage. Prezzi su richiesta.

FR > 6 formes à rabat disponibles
Réutilisable et hermétique

ES > 6 formas de solapa diferentes disponibles
Reutilizable y hermético

DE > 6 Klappenformen erhältlich
Wiederverwendbar & hermetisch

IT > Riutilizzabile ed ermetico
Chiusura disponibile in 6 diverse forme

Packaging:

emballage / envasado /
verpackung / imballaggio



Box for 10 u. Each BIC® Pocket Ashtray comes in an individual cellophane packaging.

Printing techniques:

Techniques d'impression / Técnicas de impresión /
Drucktechniken / Tecniche di stampa



(SP) SCREEN
PRINTING

External packaging:

Emballage externe / Envasado exterior /
Außenverpackung / Imballaggio esterno



500 ± 5,5 Kg*

Check out the video

Regardez la vidéo / Mira el video /
Produktvideo / Guarda il video



Please contact your Customer Service Representative for further details. Pour de plus amples détails, veuillez contacter notre service clients. Para más detalles, por favor contacta con tu representante de atención al cliente. Bitte setzen Sie sich mit Ihrem Customer-Service-Vertreter in Verbindung, um mehr Details zu erfahren. Contatta il tuo rappresentante del servizio clienti per maggiori informazioni.



Environmentally friendly image

Decoration:

Personnalisation / Personalización / Dekoration / Decorazione

BIC® Pocket Ashtray Kraft

MOQ 10.000u.

3851

A SP: max. 5 col.

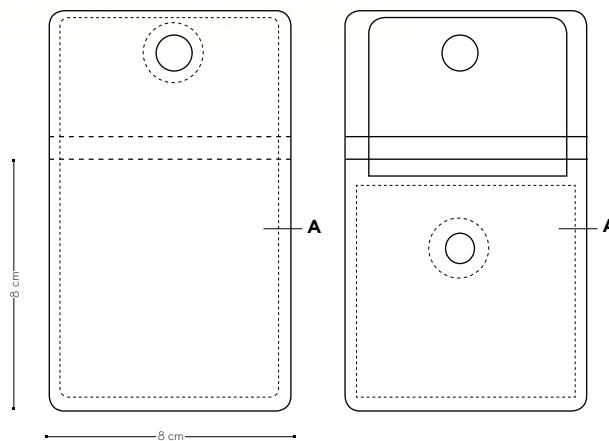

Price (€)

BIC® Pocket Ashtray	5000-9999	10000-99999	200000-249999	250000-499999	500000-749999	750000-999999	>1000000
3851	-	0,90	0,82	0,79	①	①	①

Price includes 1 imprint colour and legal text. Le prix inclut l'impression en 1 couleur et le texte légal. Los precios incluyen 1 impresión en 1 color y el texto legal. 1 Aufdruckfarbe und Rechtshinweis im Preis inbegriffen. Il prezzo include la stampa a 1 colore e testo legale.

① Price under request. Prix sur demande. Precio bajo consulta. Preis auf Anfrage. Prezzi su richiesta.

FR > Image respectueuse de l'environnement

ES > Imagen respetuosa con el medio ambiente

DE > Umweltfreundliches Image

IT > Immagine rispettosa dell'ambiente

Packaging:

emballage / envasado / verpackung / imballaggio



Box for 10 u. Each BIC® Pocket Ashtray comes in an individual cellophane packaging.

Printing techniques:

Techniques d'impression / Técnicas de impresión / Drucktechniken / Tecniche di stampa



(SP) SCREEN PRINTING

External packaging:

Emballage externe / Envasado exterior / Außenverpackung / Imballaggio esterno



500 ± 5,5 Kg*

Please contact your Customer Service Representative for further details. Pour de plus amples détails, veuillez contacter notre service clients. Para más detalles, por favor contacta con tu representante de atención al cliente. Bitte setzen Sie sich mit Ihrem Customer-Service-Vertreter in Verbindung, um mehr Details zu erfahren. Contatta il tuo rappresentante del servizio clienti per maggiori informazioni.



FOR MEN

302 BIC® Comfort 2

304 BIC® Flex3 Classic™

306 BIC® Flex4

FOR WOMEN

308 BIC® Comfort2 Lady

310 BIC® Pure 3® Lady

312 BIC® Soleil® Bella® Lady





To cut the hair without irritating the skin, the blade edge, invisible to the naked eye, must be perfectly smooth. Finding the balance between features like comfort, smoothness or closeness is key to meet user expectations



FR > Pour couper les poils sans irriter la peau, le fil de la lame, invisible à l'œil nu, doit être parfaitement aiguisé. Trouver l'équilibre entre le confort, la douceur et la précision est la clé pour répondre aux attentes de l'utilisateur.

DE > Um die Haare zu rasieren, ohne die Haut zu reizen, muss die Klingenkante - mit bloßem Auge unsichtbar - perfekt glatt sein. Das richtige Gleichgewicht aus Charakteristika wie Komfort, Glätte und Gründlichkeit ist der Schlüssel, um den Erwartungen der Benutzer gerecht zu werden.

ES > Para cortar el pelo sin irritar la piel, el borde de la hoja, inapreciable a simple vista debe ser perfectamente suave. Encontrar el equilibrio entre características como confort, suavidad o apurados es clave para satisfacer las expectativas de los usuarios.

IT > Per tagliare il pelo senza irritare la pelle, il bordo della lama, invisibile a occhio nudo, deve essere perfettamente liscio. Trovare il perfetto equilibrio tra comfort, delicatezza e precisione è fondamentale per soddisfare le aspettative dell'acquirente



BIC SHAVERS



Comfort 2 For men

MOA 500v.

BIC® Comfort 2
3128



05

FR > Manche anti-dérapant en polystyrène / Rasoir deux lames / Grande bande lubrifiante à l'aloë vera et aux vitamines A et E / Tête fixe étroite

ES > Mango antideslizante de poliestireno / Maquinilla de dos hojas / Gran banda lubricante con aloe vera, vitaminas A y E / Cabezal fijo y estrecho

DE > Rutschfester Polystyren-Griff / Zwei-Klingen-Rasierer / Großer Gleitstreifen mit Aloe Vera, Vitamin A und E / Fester schmaler Kopf

IT > Impugnatura antiscivolo in polistireno / Rasoio a doppia lama / Ampia striscia lubrificante con aloe vera, vitamina A ed E / Testa del rasoio rigida e stretta

Printing techniques:

Techniques d'impression / Técnicas de impresión / Drucktechniken / Tecniche di stampa



(DG) DIGITAL



Decoration:

Personalisation / Personalización /
Dekoration / Decorazione

BIC® Comfort 2

3128

Flow pack (small)

A DG: full-colour

Shaver +
Flow Pack



Shaver + Gel +
Flow Pack

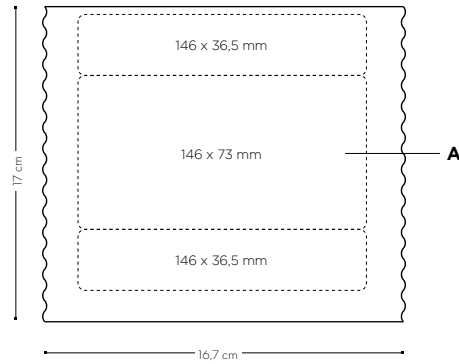

Price (€)

BIC® Comfort 2

500-499 1000-2499 2500-4999 5000-9999 10000-24999 25000-49999

Shaver + Flow Pack

DG	1,62	1,06	0,78	0,59	0,47	0,41
-----------	------	------	------	------	------	------

Shaver + Gel + Flow Pack

DG	1,95	1,39	1,08	0,89	ⓘ	ⓘ
-----------	------	------	------	------	---	---

Prices include fully personalised packaging in 4-colour process. Le prix inclut l'emballage totalement personnalisé en quadrichromie. Los precios incluyen el envasado totalmente personalizado en cuatricromía. In den Preisen sind mit Vierfarbdruck voll personalisierte Verpackungen inbegriffen. I prezzi includono imballaggio completamente personalizzato con processo in quadricromia

ⓘ Price under request. Prix sur demande. Precio bajo consulta. Preis auf Anfrage. Prezzi su richiesta.

Carton box (small)

A DG: full-colour

Shaver +
Carton Box



Shaver + Gel +
Carton Box

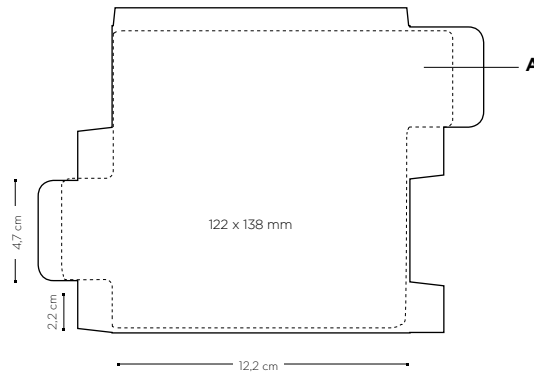

Price (€)

BIC® Comfort 2

500-499 1000-2499 2500-4999 5000-9999 10000-24999 25000-49999

Shaver + Carton Box

DG	2,54	1,51	0,98	0,72	0,54	0,46
-----------	------	------	------	------	------	------

Shaver + Gel + Carton Box

DG	2,87	1,84	1,28	1,02	ⓘ	ⓘ
-----------	------	------	------	------	---	---

Prices include fully personalised packaging in 4-colour process. Le prix inclut l'emballage totalement personnalisé en quadrichromie. Los precios incluyen el envasado totalmente personalizado en cuatricromía. In den Preisen sind mit Vierfarbdruck voll personalisierte Verpackungen inbegriffen. I prezzi includono imballaggio completamente personalizzato con processo in quadricromia

ⓘ Price under request. Prix sur demande. Precio bajo consulta. Preis auf Anfrage. Prezzi su richiesta.



BIC® Flex3 Classic™

For men

MOA 500v.

BIC® Flex3 Classic™
3129



FR > Grande barre de protection / Tête pivotante qui épouse les contours du visage / Bande lubrifiante à l'aloë vera et à la vitamine E / 3 lames mobiles / Poignée incurvée à prise souple pour un bon contrôle du rasage

ES > Gran barra de protección / Cabezal pivotante para adaptarse a los contornos de la cara / Banda lubricante con aloe vera y vitamina E / 3 hojas móviles / Mango curvo con grip suave para un mejor control de afeitado

07

Curved handle with a soft grip for a good control of shaving

DE > Großer Schutzstreifen / Beweglicher Kopf passt sich den Gesichtskonturen an / Gleitstreifen mit Aloe Vera und Vitamin E / 3 bewegliche Klingen / Geschwungener Softgriff für eine kontrollierte Rasur

IT > Ampia barretta di sicurezza / Testa pivotante che si adatta ai contorni del viso / Striscia lubrificante con aloe vera e vitamina E / 3 lame mobili / Manico curvo con impugnatura morbida per un buon controllo della rasatura

Printing techniques:

Techniques d'impression / Técnicas de impresión / Drucktechniken / Tecniche di stampa



(DG) DIGITAL



Decoration:

Personalisation / Personalización /
Dekoration / Decorazione

BIC® Flex3 Classic™

3129

Flow pack (small)

A DG: full-colour

Shaver +
Flow Pack



Shaver + Gel +
Flow Pack

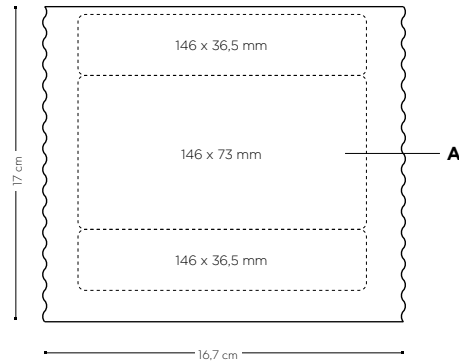

Price (€)

BIC® Flex3 Classic™

500-499 1000-2499 2500-4999 5000-9999 10000-24999 25000-49999

Shaver + Flow Pack

DG	2,05	1,47	1,17	0,96	0,82	0,74
-----------	------	------	------	------	------	------

Shaver + Gel + Flow Pack

DG	2,38	1,80	1,47	1,26	①	①
-----------	------	------	------	------	---	---

Prices include fully personalised packaging in 4-colour process. Le prix inclut l'emballage totalement personnalisé en quadrichromie. Los precios incluyen el envasado totalmente personalizado en cuatricromía. In den Preisen sind mit Vierfarbdruck voll personalisierte Verpackungen inbegriffen. I prezzi includono imballaggio completamente personalizzato con processo in quadricromia

① Price under request. Prix sur demande. Precio bajo consulta. Preis auf Anfrage. Prezzi su richiesta.

Carton box (small)

A DG: full-colour

Shaver +
Carton Box



Shaver + Gel +
Carton Box

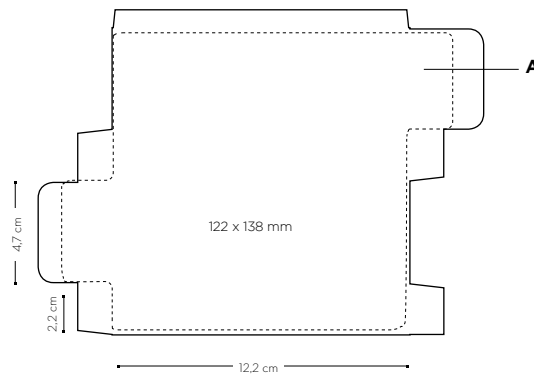

Price (€)

BIC® Flex3 Classic™

500-499 1000-2499 2500-4999 5000-9999 10000-24999 25000-49999

Shaver + Carton Box

DG	2,97	1,92	1,37	1,09	0,89	0,79
-----------	------	------	------	------	------	------

Shaver + Gel + Carton Box

DG	3,30	2,25	1,67	1,39	①	①
-----------	------	------	------	------	---	---

Prices include fully personalised packaging in 4-colour process. Le prix inclut l'emballage totalement personnalisé en quadrichromie. Los precios incluyen el envasado totalmente personalizado en cuatricromía. In den Preisen sind mit Vierfarbdruck voll personalisierte Verpackungen inbegriffen. I prezzi includono imballaggio completamente personalizzato con processo in quadricromia

① Price under request. Prix sur demande. Precio bajo consulta. Preis auf Anfrage. Prezzi su richiesta.



Moveable Blades
Lames amovibles
Hojas móviles
Bewegliche Klingen
Lame mobili



MADE IN
GREECE

BIC Flex4
For men

MOA 500v.

BIC® Flex4
3130



FR > Grande barre de protection / Tête pivotante / Bande lubrifiante à l'aloë vera et à la vitamine E / 4 lames nano technologie, qui épousent individuellement les contours du visage / Manche ergonomique lourd, avec zone de préhension caoutchoutée

ES > Gran barra de protección / Cabezal pivotante / Banda lubricante con aloe vera y vitamina E / 4 hojas hechas con nano tecnología, se adaptan individualmente al contorno de la cara / Mango de fácil manejo con agarre de goma

DE > Großer Schutzstreifen / Beweglicher Kopf / Gleitstreifen mit Aloe Vera und Vitamin E / 4 Nanotechnologie-Klingen passen sich den Gesichtskonturen individuell an / Komfortabler schwerer Griff mit Gummierung

IT > Ampia barretta di sicurezza / Testa pivotante / Striscia lubrificante con aloe vera e vitamina E / 4 lame nano tech che si adattano singolarmente ai contorni del viso / Impugnatura comoda e pesante con gomma antiscivolo

Printing techniques:

Techniques d'impression / Técnicas de impresión / Drucktechniken / Tecniche di stampa



(DG) DIGITAL



Decoration:

Personnalisation / Personalización /
Dekoration / Decorazione

BIC® Flex4 3130

Flow pack (big)

A DG: full-colour

Shaver +
Flow Pack



Shaver + Gel +
Flow Pack

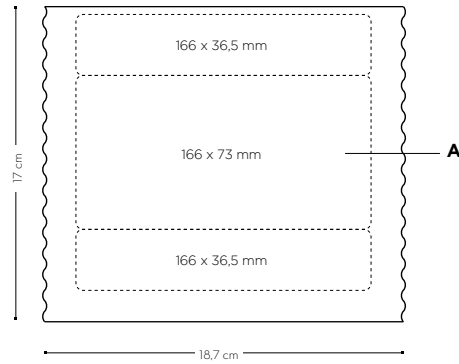

Price (€)

BIC® Flex4	500-499	1000-2499	2500-4999	5000-9999	10000-24999	25000-49999
Shaver + Flow Pack						
DG	2,35	1,75	1,43	1,20	1,05	0,96
Shaver + Gel + Flow Pack						
DG	2,68	2,08	1,73	1,50	①	①

Prices include fully personalised packaging in 4-colour process. Le prix inclut l'emballage totalement personnalisé en quadrichromie. Los precios incluyen el envasado totalmente personalizado en cuatricromía. In den Preisen sind mit Vierfarbdruck voll personalisierte Verpackungen inbegriffen. I prezzi includono imballaggio completamente personalizzato con processo in quadricromia

① Price under request. Prix sur demande. Precio bajo consulta. Preis auf Anfrage. Prezzi su richiesta.

Carton box (big)

A DG: full-colour

Shaver +
Carton Box



Shaver + Gel +
Carton Box

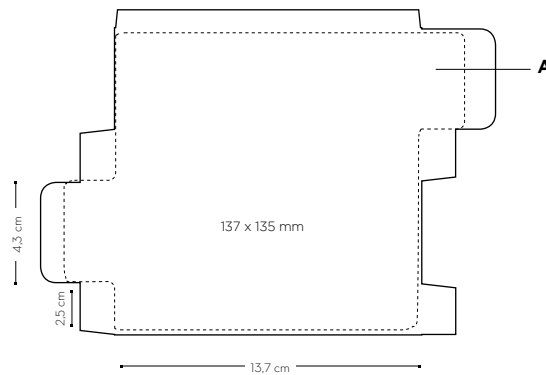

Price (€)

BIC® Flex4	500-499	1000-2499	2500-4999	5000-9999	10000-24999	25000-49999
Shaver + Carton Box						
DG	3,44	2,28	1,68	1,37	1,15	1,04
Shaver + Gel + Carton Box						
DG	3,77	2,61	1,98	1,67	①	①

Prices include fully personalised packaging in 4-colour process. Le prix inclut l'emballage totalement personnalisé en quadrichromie. Los precios incluyen el envasado totalmente personalizado en cuatricromía. In den Preisen sind mit Vierfarbdruck voll personalisierte Verpackungen inbegriffen. I prezzi includono imballaggio completamente personalizzato con processo in quadricromia

① Price under request. Prix sur demande. Precio bajo consulta. Preis auf Anfrage. Prezzi su richiesta.



Moveable Blades
Lames amovibles
Hojas móviles
Bewegliche Klingen
Lame mobili



MADE IN
GREECE

Comfort 2 Lady For Women

MOA 500v.

BIC® Comfort 2 Lady
3131

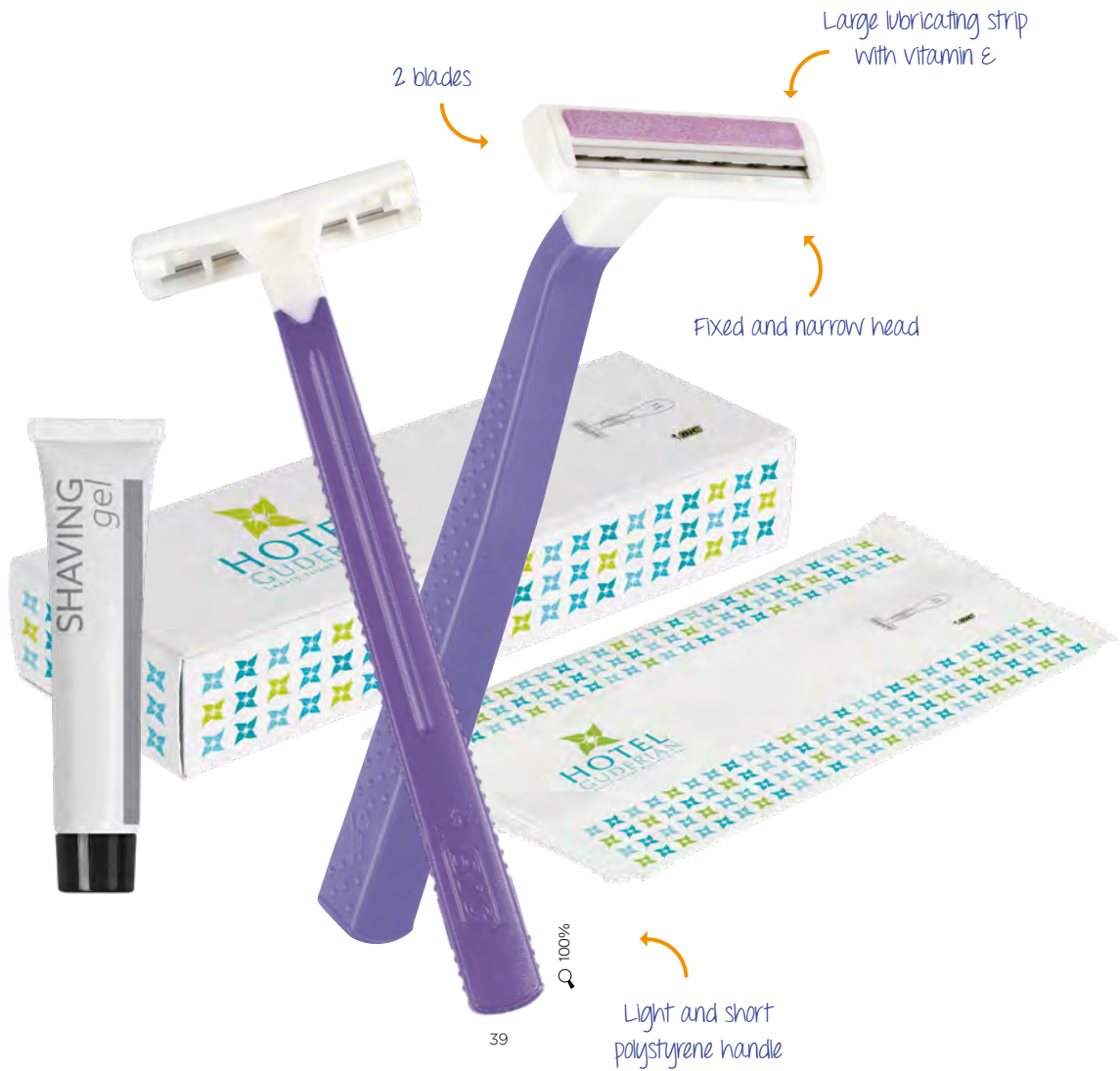

39

FR > 2 lames / Grande bande lubrifiante à la vitamine E / Tête fixe / Manche court et léger en polystyrène

ES > 2 hojas / Banda lubricante con vitamina E / Cabezal fijo / Mango corto y ligero de poliestireno.

DE > 2 Klingen / Großer Gleitstreifen mit Vitamin E / Fester Kopf / Leichter, kurzer Polystyren-Griff

IT > 2 lame / Ampia striscia lubrificante con vitamina E / Testa rigida / Manico leggero e corto in polistirene

Printing techniques:

Techniques d'impression / Técnicas de impresión / Drucktechniken / Tecniche di stampa



(DG) DIGITAL

(Until stock lasts) Jusqu'à épuisement du stock / Hasta que se acabe el stock / Solange der Vorrat reicht / Fino a esaurimento scorte



Decoration:

Personalisation / Personalización /
Dekoration / Decorazione

BIC® Comfort 2 Lady 3131

Flow pack (small)

A DG: full-colour

Shaver +
Flow Pack



Shaver + Gel +
Flow Pack

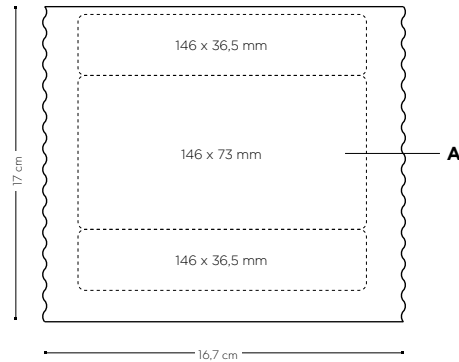

Price (€)

BIC® Comfort 2 Lady	500-499	1000-2499	2500-4999	5000-9999	10000-24999	25000-49999
Shaver + Flow Pack						
DG	1,62	1,06	0,78	0,59	0,47	0,41
Shaver + Gel + Flow Pack						
DG	1,95	1,39	1,08	0,89	ⓘ	ⓘ

Prices include fully personalised packaging in 4-colour process. Le prix inclut l'emballage totalement personnalisé en quadrichromie. Los precios incluyen el envasado totalmente personalizado en cuatricromía. In den Preisen sind mit Vierfarbdruck voll personalisierte Verpackungen inbegriffen. I prezzi includono imballaggio completamente personalizzato con processo in quadricromia

ⓘ Price under request. Prix sur demande. Precio bajo consulta. Preis auf Anfrage. Prezzi su richiesta.

Carton box (small)

A DG: full-colour

Shaver +
Carton Box



Shaver + Gel +
Carton Box

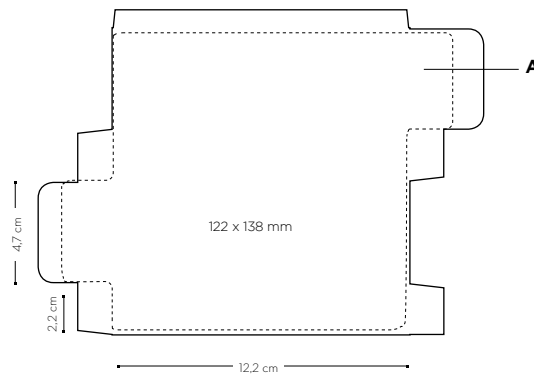

Price (€)

BIC® Comfort 2 Lady	500-499	1000-2499	2500-4999	5000-9999	10000-24999	25000-49999
Shaver + Carton Box						
DG	2,54	1,51	0,98	0,72	0,54	0,46
Shaver + Gel + Carton Box						
DG	2,87	1,84	1,28	1,02	ⓘ	ⓘ

Prices include fully personalised packaging in 4-colour process. Le prix inclut l'emballage totalement personnalisé en quadrichromie. Los precios incluyen el envasado totalmente personalizado en cuatricromía. In den Preisen sind mit Vierfarbdruck voll personalisierte Verpackungen inbegriffen. I prezzi includono imballaggio completamente personalizzato con processo in quadricromia

ⓘ Price under request. Prix sur demande. Precio bajo consulta. Preis auf Anfrage. Prezzi su richiesta.

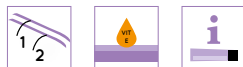

Pure 3[®] Lady For Women

MOA 500v.

BIC[®] Pure 3[®] Lady
3132

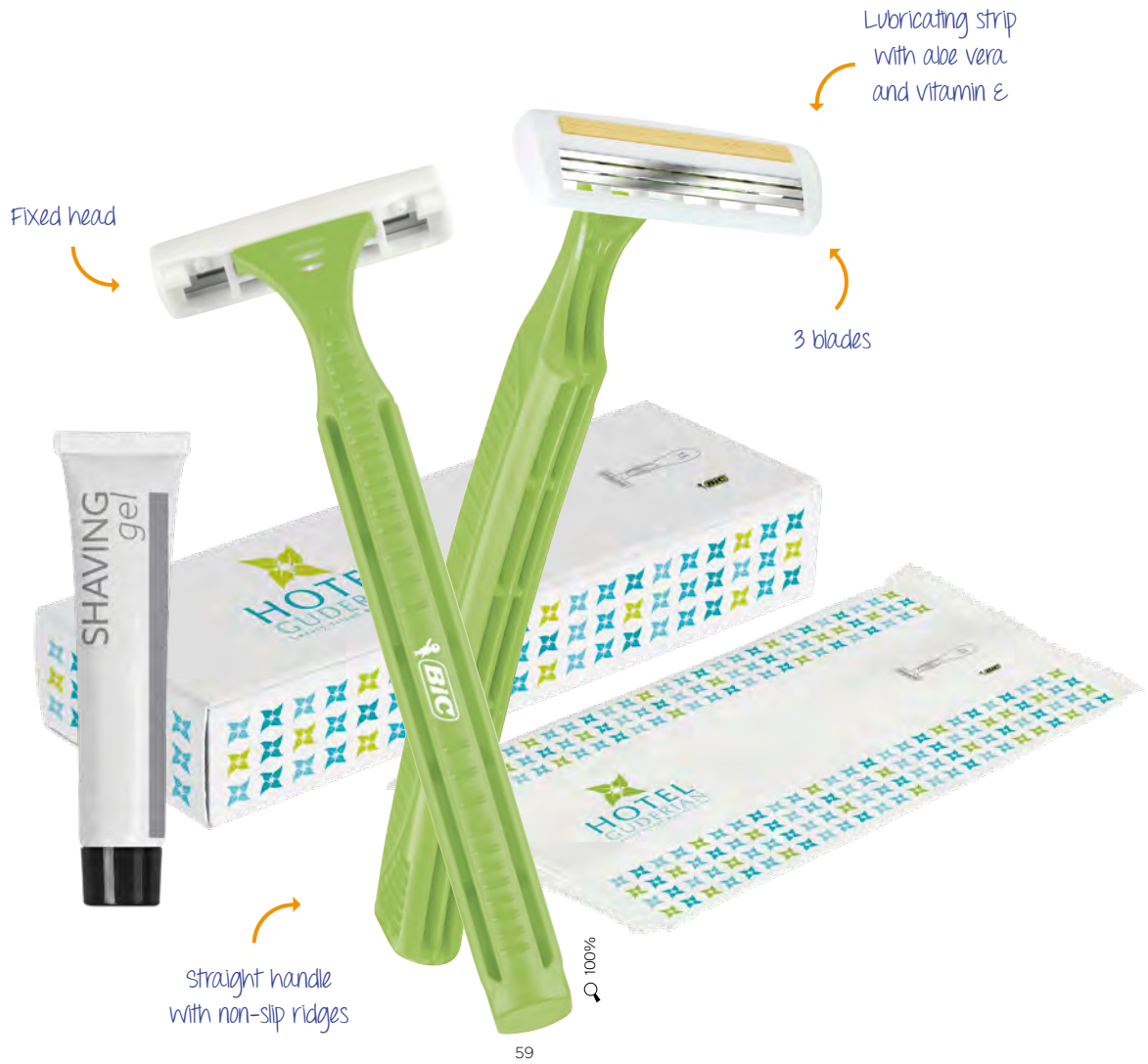

BIC[®] SHAVERS
FOR WOMEN

FR > Tête fixe / Bande lubrifiante à l'aloë vera et à la vitamine E / 3 lames / Manche droit avec stries antidérapantes

ES > Cabezal fijo / Banda lubricante con aloe vera y vitamina E / 3 hojas / Mango recto con rebordes antideslizantes

DE > Fester Kopf / Gleitstreifen mit Aloe Vera und Vitamin E / 3 Klingen / Gerader Griff mit Antrutsch-Schlitz

IT > Testa rigida / Striscia lubrificante con aloe vera e vitamina E / 3 lame / Impugnatura dritta con rilievi antiscivolo

Printing techniques:

Techniques d'impression / Técnicas de impresión / Drucktechniken / Tecniche di stampa



(DG) DIGITAL



Decoration:

Personalisation / Personalización /
Dekoration / Decorazione

BIC® Pure 3® Lady 3132

Flow pack (small)

A DG: full-colour

Shaver +
Flow Pack



Shaver + Gel +
Flow Pack

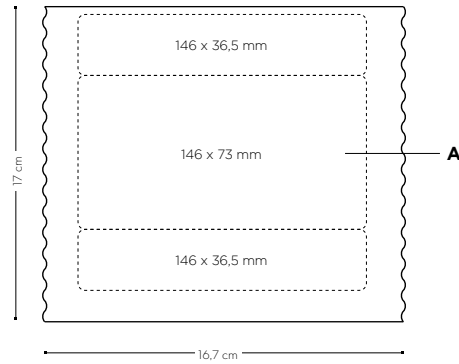

Price (€)

BIC® Pure 3® Lady

500-499 1000-2499 2500-4999 5000-9999 10000-24999 25000-49999

Shaver + Flow Pack

DG	1,77	1,21	0,91	0,71	0,60	0,54
-----------	------	------	------	------	------	------

Shaver + Gel + Flow Pack

DG	2,10	1,54	1,21	1,01	①	①
-----------	------	------	------	------	---	---

Prices include fully personalised packaging in 4-colour process. Le prix inclut l'emballage totalement personnalisé en quadrichromie. Los precios incluyen el envasado totalmente personalizado en cuatricromía. In den Preisen sind mit Vierfarbdruck voll personalisierte Verpackungen inbegriffen. I prezzi includono imballaggio completamente personalizzato con processo in quadricromia

① Price under request. Prix sur demande. Precio bajo consulta. Preis auf Anfrage. Prezzi su richiesta.

Carton box (small)

A DG: full-colour

Shaver +
Carton Box



Shaver + Gel +
Carton Box

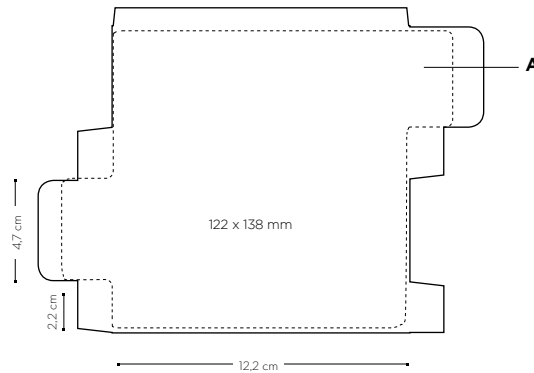

Price (€)

BIC® Pure 3® Lady

500-499 1000-2499 2500-4999 5000-9999 10000-24999 25000-49999

Shaver + Carton Box

DG	2,69	1,66	1,11	0,84	0,67	0,59
-----------	------	------	------	------	------	------

Shaver + Gel + Carton Box

DG	3,02	1,99	1,41	1,14	①	①
-----------	------	------	------	------	---	---

Prices include fully personalised packaging in 4-colour process. Le prix inclut l'emballage totalement personnalisé en quadrichromie. Los precios incluyen el envasado totalmente personalizado en cuatricromía. In den Preisen sind mit Vierfarbdruck voll personalisierte Verpackungen inbegriffen. I prezzi includono imballaggio completamente personalizzato con processo in quadricromia

① Price under request. Prix sur demande. Precio bajo consulta. Preis auf Anfrage. Prezzi su richiesta.

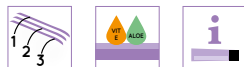

Soleil® Bella® Lady FOR WOMEN

MOA 500v.

BIC® Soleil® Bella® Lady
3133



BIC® SHAVERS
FOR WOMEN

FR > 4 lames mobiles / Tête pivotante / Bande lubrifiante au lait de coco / Grande barre de protection / Manche ergonomique incurvé avec zone de préhension Soft-Griff

ES > 4 hojas móviles / Cabezal pivotante / Banda lubricante con leche de coco / Gran barra de protección / Mango ergonómico con agarre de goma

DE > 4 bewegliche Klingen / Beweglicher Kopf / Gleitstreifen mit Kokosnussmilch / Großer Schutzstreifen / Komfortabler, geschwungener Soft-Griff

IT > 4 lame mobili / Testa pivotante / Striscia lubrificante con latte di cocco / Ampia barretta di sicurezza / Impugnatura comoda e curva con gomma antiscivolo

Printing techniques:

Techniques d'impression / Técnicas de impresión / Drucktechniken / Tecniche di stampa



(DG) DIGITAL



86



Decoration:

Personalisation / Personalización /
Dekoration / Decorazione

BIC® Soleil® Bella® Lady 3133

Flow pack (big)

A DG: full-colour

Shaver +
Flow Pack



Shaver + Gel +
Flow Pack

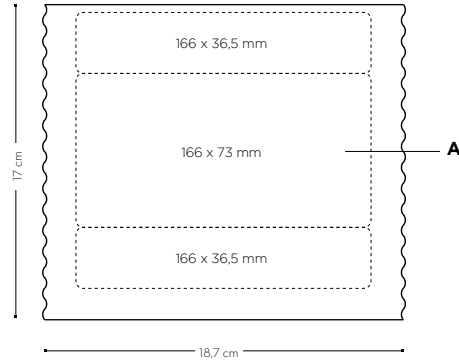

Price (€)

Bic® Soleil® Bella® Lady

500-499 1000-2499 2500-4999 5000-9999 10000-24999 25000-49999

Shaver + Flow Pack

DG	2,35	1,75	1,43	1,20	1,05	0,96
-----------	------	------	------	------	------	------

Shaver + Gel + Flow Pack

DG	2,68	2,08	1,73	1,50	①	①
-----------	------	------	------	------	---	---

Prices include fully personalised packaging in 4-colour process. Le prix inclut l'emballage totalement personnalisé en quadrichromie. Los precios incluyen el envasado totalmente personalizado en cuatricromía. In den Preisen sind mit Vierfarbdruck voll personalisierte Verpackungen inbegriffen. I prezzi includono imballaggio completamente personalizzato con processo in quadricromia

① Price under request. Prix sur demande. Precio bajo consulta. Preis auf Anfrage. Prezzi su richiesta.

Carton box (big)

A DG: full-colour

Shaver +
Carton Box



Shaver + Gel +
Carton Box

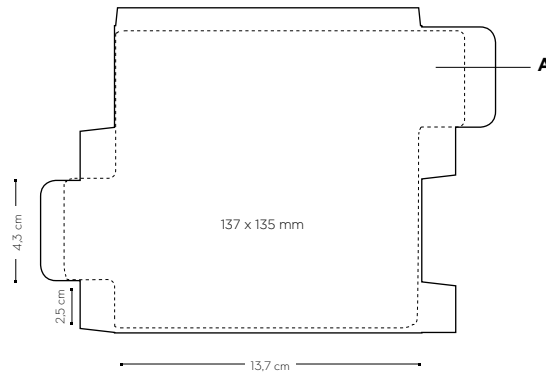

Price (€)

Bic® Soleil® Bella® Lady

500-499 1000-2499 2500-4999 5000-9999 10000-24999 25000-49999

Shaver + Carton Box

DG	3,44	2,28	1,68	1,37	1,15	1,04
-----------	------	------	------	------	------	------

Shaver + Gel + Carton Box

DG	3,77	2,61	1,98	1,67	①	①
-----------	------	------	------	------	---	---

Prices include fully personalised packaging in 4-colour process. Le prix inclut l'emballage totalement personnalisé en quadrichromie. Los precios incluyen el envasado totalmente personalizado en cuatricromía. In den Preisen sind mit Vierfarbdruck voll personalisierte Verpackungen inbegriffen. I prezzi includono imballaggio completamente personalizzato con processo in quadricromia

① Price under request. Prix sur demande. Precio bajo consulta. Preis auf Anfrage. Prezzi su richiesta.



Moveable Blades
Lames amovibles
Hojas móviles
Bewegliche Klingen
Lame mobili



MADE IN
GREECE



BACKPACKS

320 BIC® Classic Backpack

318 BIC® Drawstring Backpack

ACCESSORIES

322 BIC® Multi-use Pouch





 **BIC** Bags



Bags

Modern design, lightweight and multi-functional backpacks and useful accessories.

BIC® BAGS
BACKPACKS

FR > Sacs à dos multifonctionnels et accessoires utiles au design moderne, de conception légère.

DE > Modernes Design, leichte Multifunktionsrucksäcke und nützliche Accessoires.

ES > Mochilas funcionales con un diseño moderno, ligero y con útiles accesorios.

IT > Zainetti multifunzionali leggeri e dal design moderno con utili accessori.





BACKPACKS
BIC® BAGS



BIC® Drawstring Backpack

3450



12

03

59

25

02

BIC® BAGS
BACKPACKS



FR > Anse avec détail en PU
Etiquette BIC® porte-nom
Fermeture-éclair réfléchissante décorative
Forro interior con el logo BIC®
Partie en maille au dos du sac
Logo BIC® en silicone

ES > Asa con contraste de PU
Etiqueta BIC® para el nombre
Cremallera con banda reflectante decorativa
Doblure avec logo BIC®
Panel de malla adicional en la parte trasera
Logo BIC® de silicona

DE > Tragegriff mit kontrastierendem PU-Element
BIC®-Namensschild
Dekorativer, reflektierender Reißverschluss
Futter mit BIC®-Logo
Netzeinsatz auf der Rückseite
BIC®-Logo aus Silikon

IT > Maniglia con inserti in PU
Targhetta portanome con logo BIC®
Cerniera riflettente decorativa
Fodera con logo
Pannello a rete aggiunto sul retro
Logo BIC® in silicone



MOQ 250.

Decoration:

Personnalisation / Personalización / Dekoration / Decorazione

BIC® Drawstring Backpack

3450

A SP: max. 2 col.

B OT: 4-colour process

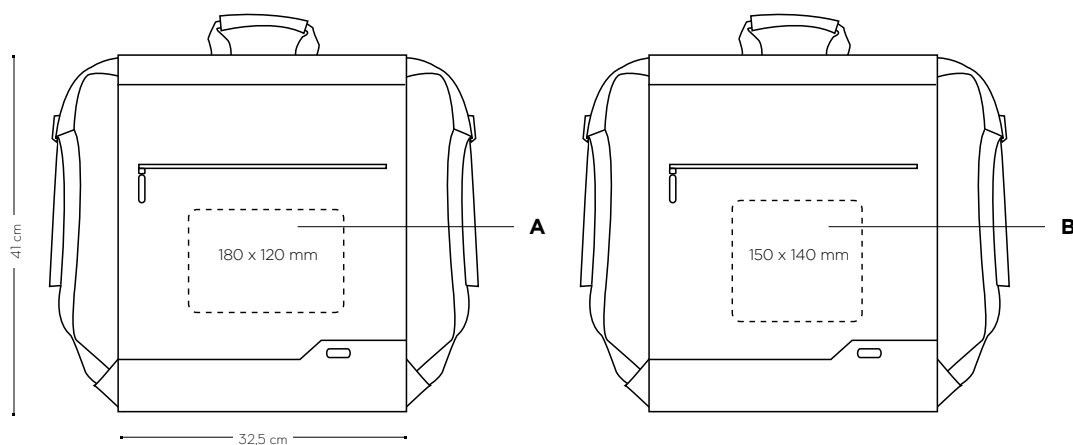

	Price (€)						
BIC® Drawstring Backpack	25-49	50-99	100-249	250-499	500-999	1000-2499	2500-4999
3450							
SP	9,99	9,59	9,21	8,84	8,49	①	①
OT	-	-	-	-	9,42	①	①

ADDITIONAL CHARGES: coûts supplémentaires / cargos adicionales / aufpreise / costi aggiuntivi:

SP	1,87	1,54	1,27	1,05	0,87	①	①
-----------	------	------	------	------	------	---	---

SP: prices include 1 colour in 1 position SP : Les prix incluent 1 couleur sur 1 emplacement. SP: precios incluyen 1 color en una posición SP: 1 Farbe auf 1 Position in den Preisen inbegriffen SP: i prezzi includono 1 colore in 1 posizione

OT: prices include 4-colour process imprint OT : Les prix incluent l'impression en quadrichromie. OT: los precios incluyen una impresión en cuatricromía OT: Vierfarbdruck in den Preisen inbegriffen OT: i prezzi includono la stampa con processo in quadricromia

① Price under request. Prix sur demande. Precio bajo consulta. Preis auf Anfrage. Prezzi su richiesta.

Printing techniques:

Techniques d'impression / Técnicas de impresión / Drucktechniken / Tecniche di stampa



(SP) SCREEN PRINTING



(OT) OFFSET TRANSFER

External packaging:

Emballage externe / Envasado exterior / Außenverpackung / Imballaggio esterno



50 ± 6,8 Kg

Check out the video

Regardez la vidéo / Mira el vídeo / Produktvideo / Guarda il video



Classic Backpack

3451



12

03

59

25

02

BIC® BAGS
BACKPACKS



Padded pocket and useful organizer

BIC® name tag

Decorative reflective zipper

Diamond pattern

Silicone BIC® logo

Lining with BIC® logo

Useful strap for placing on a trolley

FR > Poche rembourrée et organisateur très utile
Etiquette BIC® porte-nom
Fermeture-éclair réfléchissante décorative
Motifs en forme de losanges
Doublure avec logo BIC®
Logo BIC® en silicone
Sangle très pratique pour suspendre le sac à un chariot

ES > Bolsillo acolchado y práctico organizador
Etiqueta BIC® para el nombre
Cremallera con banda reflectante decorativa
Patrón en forma de diamante
Forro interior con el logo BIC®
Logo BIC® de silicona
Práctica correa para ponerla en una trolley

DE > Gepolsterte Tasche und praktischer Organizer
BIC®-Namensschild
Dekorativer, reflektierender Reißverschluss
Diamantmuster
Futter mit BIC®-Logo
BIC®-Logo aus Silikon
Praktisches Band zur Befestigung am Trolley

IT > Tasca imbottita e utile organizer
Targhetta portanome con logo BIC®
Cerniera riflettente decorativa
Motivo a rombi
Fodera con logo
Logo BIC® in silicone
Cinghie per il fissaggio su un trolley



MOQ 250.

Decoration:

Personnalisation / Personalización / Dekoration / Decorazione

BIC® Classic Backpack

3451

A SP: max. 2 col.

B OT: 4-colour process

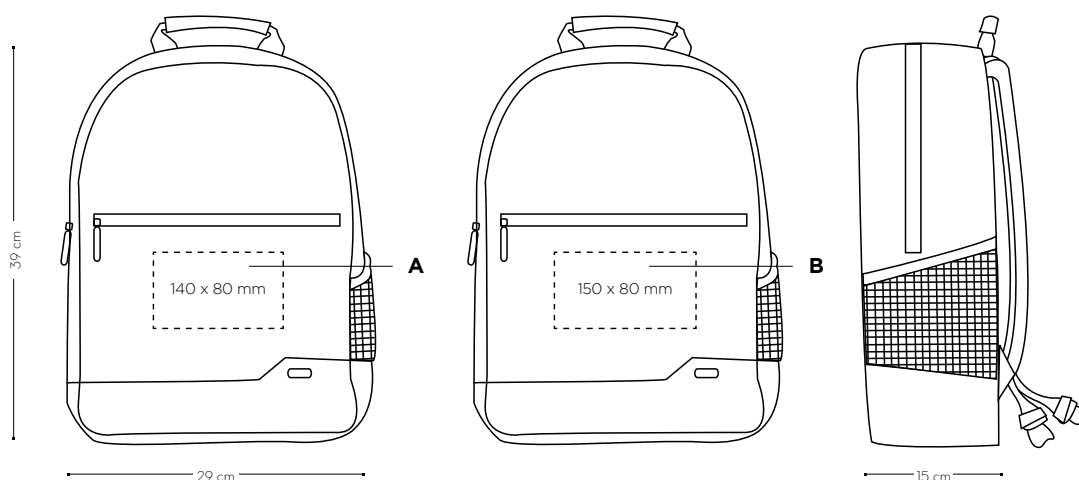

BACKPACKS
BIC® BAGS

	Price (€)						
BIC® Classic Backpack	25-49	50-99	100-249	250-499	500-999	1000-2499	2500-4999
3451							
SP	19,97	19,17	18,40	17,66	16,95	①	①
OT	-	-	-	-	17,88	①	①

ADDITIONAL CHARGES: coûts supplémentaires: / cargos adicionales: / aufpreise: / costi aggiuntivi:

SP	1,87	1,54	1,27	1,05	0,87	①	①
-----------	------	------	------	------	------	---	---

SP: prices include 1 colour in 1 position SP : Les prix incluent 1 couleur sur 1 emplacement. SP: precios incluyen 1 color en una posición SP: 1 Farbe auf 1 Position in den Preisen inbegriffen SP: i prezzi includono 1 colore in 1 posizione
OT: prices include 4-colour process imprint OT : Les prix incluent l'impression en quadrichromie. OT: los precios incluyen una impresión en cuatricromía OT: Vierfarbdruck in den Preisen inbegriffen OT: i prezzi includono la stampa con processo in quadricromia

① Price under request. Prix sur demande. Precio bajo consulta. Preis auf Anfrage. Prezzi su richiesta.

Printing techniques:

Techniques d'impression / Técnicas de impresión / Drucktechniken / Tecniche di stampa



(SP) SCREEN
PRINTING



(OT) OFFSET
TRANSFER

External packaging:

Emballage externe / Envasado exterior / Außenverpackung / Imballaggio esterno



25 ± 8,7 Kg

Check out the video

Regardez la vidéo / Mira el video / Produktvideo / Guarda il video



BIC® Multi-use Pouch

3452



12

03

59

25

02

BIC® BAGS
ACCESSORIES



Decorative
reflective zipper

Diamond pattern

Lining with
BIC® logo

BIC® name tag

Silicone BIC® logo

FR > Fermeture-éclair réfléchissante décorative
Motifs en forme de losanges
Doublure avec logo BIC®
Étiquette BIC® porte-nom
Logo BIC® en silicone

ES > Cremallera con banda reflectante decorativa
Patrón en forma de diamante
Forro interior con el logo BIC®
Etiqueta BIC® para el nombre
Logo BIC® de silicona

DE > Dekorativer, reflektierender Reißverschluss
Diamantmuster
Futter mit BIC®-Logo
BIC®-Namensschild
BIC®-Logo aus Silikon

IT > Cerniera riflettente decorativa
Motivo a rombi
Fodera con logo
Targhetta portanome con logo BIC®
Logo BIC® in silicone

75%



MOQ 500.

Decoration:

Personnalisation / Personalización / Dekoration / Decorazione

BIC® Multi-use Pouch

3452

A SP: max. 1 col.

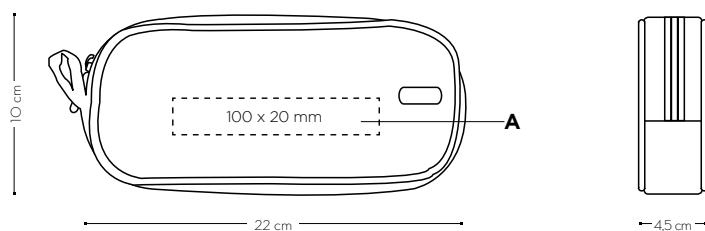

	Price (€)					
BIC® Multi-use Pouch	50-99	100-249	250-499	500-999	1000-2499	2500-4999
3452						
SP	5,28	5,07	4,86	4,67	①	①

SP: prices include 1 colour in 1 position **SP:** Les prix incluent 1 couleur sur 1 emplacement. **SP:** precios incluyen 1 color en una posición **SP:** 1 Farbe auf 1 Position in den Preisen inbegriffen **SP:** i prezzi includono 1 colore in 1 posizione

① Price under request. Prix sur demande. Precio bajo consulta. Preis auf Anfrage. Prezzi su richiesta.

Printing techniques:

Techniques d'impression / Técnicas de impresión / Drucktechniken / Tecniche di stampa



(SP) SCREEN
PRINTING

External packaging:

Emballage externe / Envasado exterior / Außenverpackung / Imballaggio esterno



100 ± 5,8 Kg

Check out the video

Regardez la video / Mira el video / Produktvideo / Guarda il video



T'nB®

- 349 T'nB® 4K Action Camera
- 347 T'nB® Active Noise Reduction Headphones
- 335 T'nB® Art Speaker
- 343 T'nB® Be Colour Headphones
- 345 T'nB® Hashtag Bluetooth® Headphones
- 348 T'nB® HD Action Camera
- 334 T'nB® Juke Speaker
- 341 T'nB® Kids Headphones
- 344 T'nB® Legend Headphones
- 338 T'nB® Live in earphones
- 329 T'nB® Lumy Wired Mouse
- 330 T'nB® Lumy Wireless Mouse
- 328 T'nB® Mini Wireless Mouse
- 340 T'nB® Motion Bluetooth® Earphones
- 327 T'nB® Rainbow Mouse
- 346 T'nB® Shine Bluetooth® Headphones
- 333 T'nB® Slim Power Bank 6000 mAh
- 342 T'nB® Sport Bluetooth® Headphones
- 336 T'nB® Sport Bluetooth® Speaker Ball
- 339 T'nB® Steel Bluetooth® Earphones
- 331 T'nB® Stone PowerBank 4000 mAh & 6600 mAh
- 332 T'nB® Ultra-slim PowerBanks 4000 mAh & MFi adapter
- 337 T'nB® Vintage Bluetooth® Speaker



SKROSS®

ADAPT TO THE WORLD

- 352 Skross® Pro Light USB
- 353 Skross® World Adapter MUV USB
- 351 Skross® World To Europe USB



Technology





T'nB® proposes intelligent and original products in multimedia, audio and video. High quality guaranteed products specially designed in France. Ideal accesories for your office and on the go.



FR > T'nB® propose des produits multimédia, audio/vidéo intelligents et originaux. Produits garantis haute qualité, conçus en France. Des accessoires idéaux que vous soyez au bureau et en déplacement.

ES > La marca T'nB® propone productos inteligentes y originales de multimedia, video y audio. Productos de alta calidad garantizada especialmente diseñados en Francia. Accesorios ideales para tu oficina y para llevar.

DE > T'nB® bietet intelligente, originelle Produkte aus dem Bereich Multimedia, Audio und Video. Qualitativ hochwertige, garantierte Produkte, in Frankreich speziell entworfen. Ideale Accessoires fürs Büro und unterwegs.

IT > T'nB® propone prodotti intelligenti e originali nel settore multimedia, audio e video. Prodotti di alta qualità garantiti, progettati in Francia. Accessori ideali in ufficio e in viaggio.

MOQ 100.



Fun and coloured wired mouse

FR > Souris fun et coloré avec cable
 ES > Divertido y colorido ratón con cable
 DE > Farbenfrohe kabelgebundene Maus
 IT > Mouse con cavo divertente e colorat



.20



.30



.32

80%

Decoration:

Personalisation / Personalización /
 Dekoration / Decorazione

T'nB® Rainbow Mouse

09699

A BP: box front, full-colour

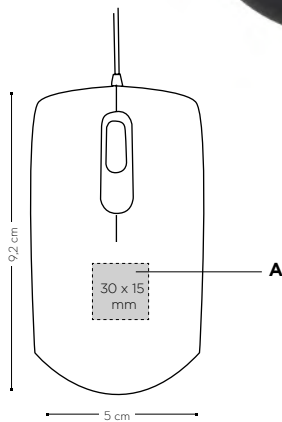

This 1000 dpi colorful mouse features 2 silent click buttons and a clickable scroll. Enjoy a fun two colors design and USB cable matching the mouse body color.

FR > Cette souris colorée, 1000 dpi, est dotée de 2 boutons et scroll cliquable. Profitez d'un design fun et bicolore et un cable USB de la même couleur que le corps de la souris.

ES > Este ratón colorido de 1000 ppp cuenta con 2 botones clic silenciosos y un scroll en el que se puede hacer clic. Disfruta de un divertido diseño de dos colores y un cable USB que combina con el color del cuerpo del ratón.

DE > Farbenfrohe 1000 dpi-Maus mit zwei leisen Schaltflächen und klickbarem Scrollrad. Genießen Sie das frische zweifarbige Design mit farblich passendem USBKabel.

IT > Il colorato mouse da 1000 dpi ha 2 pulsanti silenziosi e uno scroll su cui è possibile cliccare. Ha un divertente design bicolore e un cavo USB della stessa tonalità del corpo del mouse.

Printing techniques:

Techniques d'impression / Técnicas de impresión /
 Drucktechniken / Tecniche di stampa



(BP) britePix™



packaging:

Emballage / Envasado /
 verpackung / Imballaggio



External packaging:

Emballage externe / Envasado exterior /
 Außenverpackung / Imballaggio esterno



100 ± 10 Kg

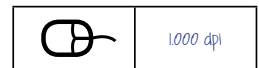

T'nB® Mini Wireless Mouse

MOQ 100.



compact size and wireless, ideal for travelling

- FR > Compact et sans câble, idéal pour voyager
- ES > Compacto y sin cables, ideal para viajar
- DE > Kompakte Größe und kabellos - ideal auf Reisen
- IT > Compatto e senza fili, ideale per viaggiare



.10

Stored below the mouse

- FR > Stocké sous la souris
- ES > Compartimento bajo el ratón
- DE > Anschluß auf der Maus-Unterseite
- IT > Stored below the mouse

Decoration:

Personnalisation / Personalización / Dekoration / Decorazione

T'nB® Mini Wireless Mouse

09668

A PD: front center, max. 1 colour

B PD: front center, max. 1 colour

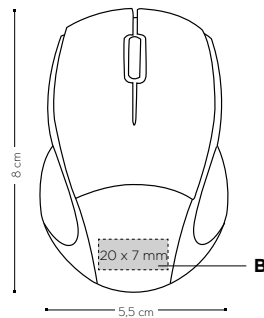
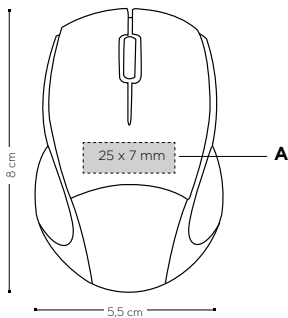

Compact size wireless optical mouse ideal for travelling. Specific compartment below the mouse to store the wireless receiver and never lose it. Automatic sleeping mode for more extended use. Silent click for maximum comfort.

FR > Souris sans fil de taille compacte, idéale pour voyager. Compartiment spécifique situé sous la souris pour loger le récepteur et ne pas l'égarer. Mode de mise en attente automatique pour une utilisation prolongée. Confort maximal grâce à son clic silencieux.

ES > Ratón inalámbrico de tamaño compacto ideal para viajar. Compartimento específico debajo del ratón para albergar el receptor y no perderlo nunca. Modo de espera automático para ampliar el uso. Click silencioso para un máximo confort.

DE > Kabellose optische Maus in kompakter Größe - ideal auf Reisen. Extrafach an der Unterseite, um den kabellosen Receiver zu verstauen und niemals zu verlieren. Automatischer Sleep-Modus als zusätzliche Nutzungsmöglichkeit. Leiser Klickton für maximalen Komfort.

IT > Mouse senza fili di dimensioni compatte ideale per viaggiare. Un apposito scomparto sotto il mouse consente di riporre il ricevitore, evitando di perderlo. Modalità sleep automatica per un uso prolungato. Click silenzioso per un comfort ottimale.

Printing techniques:

Techniques d'impression / Técnicas de impresión / Drucktechniken / Tecniche di stampa



PAD PRINTING

packaging:

Emballage / Envasado / verpackung / Imballaggio



100 ± 5,4 Kg

External packaging:

Emballage externe / Envasado exterior / Außenverpackung / Imballaggio esterno



Check out the video

Regardez la video / Mira el video / Produktvideo / Guarda il video



T'nB® Lumy Wired Mouse

MOQ 100.



Enjoy the relaxing effect of the changing colour LED backlight

- FR > Profitez de l'effet relaxant du rétro-éclairage LED à couleur changeante
- ES > Disfruta el relajante efecto de luz LED cambiante retroiluminada
- DE > Genießen Sie den entspannenden Effekt der wechselnden LEDH intergrundbeleuchtung
- IT > Goditi il rilassante effetto del LED cangiante retroilluminato



Decoration:

Personnalisation / Personalización / Dekoration / Decorazione

T'nB® Lumy Wired Mouse

09666

- A BP:** front, full-colour
- B BPT:** front, full-colour
- C PD:** front, max. 1 colour

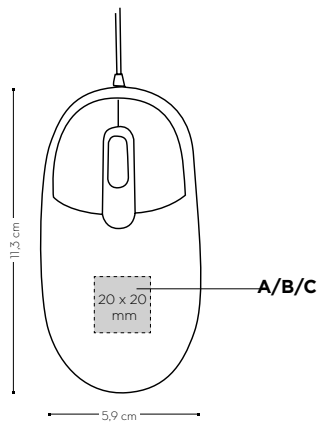

Wired 1000 DPI optical mouse with the relaxing effect of light with changing backlit colour: LED with 7 automatic colours. Two buttons and click wheel. Compatible with PC/MAC®. USB connectivity.

FR > Souris optique avec câble de 1000 DPI et effet relaxant câble à la lumière LED changeante avec 7 couleurs en alternance. Deux boutons et une molette avec clic. Compatible avec PC/MAC®. Connexion USB

ES > Ratón óptico con cable de 1000 dpi y con un efecto relajante de luz LED cambiante que alterna 7 colores. Dos botones y rueda con click. Compatible con PC/MAC®. Conexión USB.

DE > 1000 dpi optische, kabelgebundene Maus mit entspannendem Hintergrund- Lichteffekt: LEDs mit 7 automatisch wechselnden Farben. Zwei Tasten und ein Klickrad. Kompatibel für PC/MAC®. USB-Schnittstelle.

IT > Mouse ottico con cavo da 1000 dpi, con un rilassante effetto di luce LED che cambia alternando 7 colori. Due pulsanti e rotellina con click. Compatible con PC/MAC®. Collegamento USB.

Printing techniques:

Techniques d'impression / Técnicas de impresión / Drucktechniken / Tecniche di stampa



(BP) britePix™



PAD PRINTING



packaging:

Emballage / Envasado / verpackung / Imballaggio



External packaging:

Emballage externe / Envasado exterior / Außenverpackung / Imballaggio esterno



100 ± 14 Kg

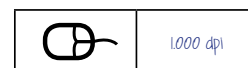

Check out the video

Regardez la video / Mira el video / Produktvideo / Guarda il video



Lumy Wireless Mouse

New!

MOA 10v.



Recover energy and good mood!

FR > Récupère de l'énergie et de la bonne humeur!
ES > Recupera la energía y el buen humor!
DE > Gesunde Energier und gute Stimmung!
IT > Recupera energia e il buon umore!



90%

.10

Decoration:

Personnalisation / Personalización /
Dekoration / Decorazione

T'nB® Lumy Wireless Mouse

09697

A BP: front, full-colour

B BPT: front, full-colour

C PD: front, max. 1 colour

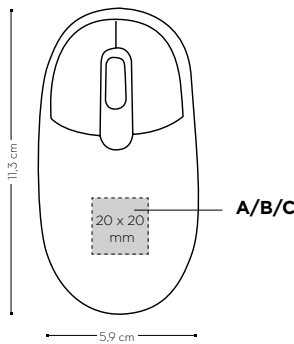

"Light therapy" wireless mouse with 8 changing colors that will relax you even at work. In order to optimize the battery life, the mouse has an ON/OFF button and an automatic standby mode.

FR > Souris sans fil type "luminothérapie" qui grâce à ses 8 couleurs changeante vous détendra même au travail. Dans un souci d'économie et d'optimisation de la durée d'utilisation de la pile, la souris dispose d'un bouton ON/OFF et un mode veille automatique.

ES > Ratón inalámbrico tipo "luminoterapia" que gracias a sus 8 colores cambiantes te relajará incluso en el trabajo. Para economizar y optimizar la duración de la batería, el ratón tiene un botón de ON/OFF y un modo de espera automático.

DE > "Lichttherapie" mit acht wechselnden Farben für eine entspannte Atmosphäre bei der Arbeit. Zur Optimierung der Batterie mit EIN/AUS-Schalter und automatischer Standby-Funktion.

IT > Mouse wireless "Luminoterapia" con 8 colori cangianti per rilassarli anche al lavoro. Per ottimizzare la durata della batteria, il mouse è dotato di un pulsante ON/OFF e una modalità di standby.

Printing techniques:

Techniques d'impression / Técnicas de impresión /
Drucktechniken / Tecniche di stampa



(BP) britePix™



PAD PRINTING



packaging:

Emballage / Envasado /
verpackung / Imballaggio



External packaging:

Emballage externe / Envasado exterior /
Außenverpackung / Imballaggio esterno



100 ± 14 Kg



1,000 dpi





Stone PowerBank 4000 mAh & 6600 mAh

MOQ 100.



Looks like a real stone

FR > Apparence comme une vraie pierre
ES > Parece una piedra real
DE > Sieht aus wie ein echter Stein
IT > Sembra una vera pietra



09664 .31



09665 .31

Velvet pouch included

FR > Pochette en velours incluse
ES > Bolsa de terciopelo incluida
DE > Samttasche inklusive
IT > Custodia in velluto inclusa

Decoration:

Personnalisation / Personalización /
Dekoration / Decorazione

T'nB® Stone PowerBank 4000 mAh

09664

A BP: front, full-colour

B BPT: front, full-colour

T'nB® Stone PowerBank 6600 mAh

09665

A BP: front, full-colour

B BPT: front, full-colour

Includes micro USB cable

FR > Câble micro USB inclus
ES > Incluye cable USB
DE > Inklusive Mikro-USB-Kabel
IT > Cavo micro USB incluso

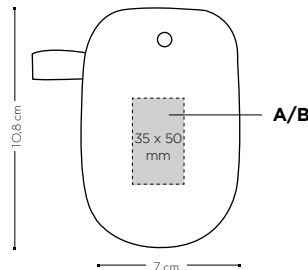
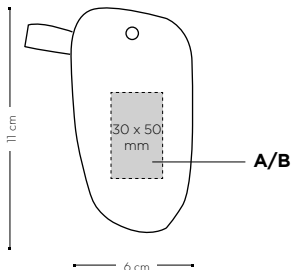

Compact power bank in the shape of a stone. Battery level is indicated with 4 lights. Includes micro USB cable.

FR > Batterie externe compacte en forme de pierre. Le niveau de charge est indiqué au moyen de 4 lumières. Câble micro USB inclus.

ES > Bateria externa compacta con forma de piedra. El nivel de carga se indica con 4 luces. Incluye cable micro USB.

DE > Kompakte Power-Bank in Form eines Steines. Der Batteriestand wird mit 4 Leuchten angezeigt. Inklusive Mikro-USB-Kabel.

IT > Batteria esterna compatta a forma di pietra. Il livello di carica viene indicato con 4 luci. Include cavo micro USB.

Printing techniques:

Techniques d'impression / Técnicas de impresión /
Drucktechniken / Tecniche di stampa



(BP) britePix™



packaging:

Emballage / Envasado /
verpackung / Imballaggio



60 ± 8.6 Kg

External packaging:

Emballage externe / Envasado exterior /
Außenverpackung / Imballaggio esterno

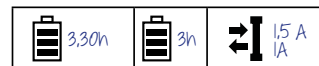

09664

09665

Check out the video

Regardez la video / Mira el video /
Produktvideo / Guarda il video



T'nB®
TECHNOLOGY



Ultra-slim PowerBanks 4000 mAh & MFi adapter

MOA 10V.

Only 8 mm thinness!

- FR > Seulement 8 mm d'épaisseur!
- ES > Sólo 8 mm de grosor!
- DE > Nur 8 mm dünn!
- IT > Solo 8 mm di spessore!



If you have an iPhone® use the lightning adapter

- FR > Si vous possédez un iPhone® utilisez l'adaptateur Lightning.
- ES > En caso de iPhone® utiliza el adaptador Lightning.
- DE > Wenn Sie ein iPhone® nutzen, verbinden Sie einfach den beigefügten Lightning-Adapter.
- IT > Se hai un iPhone® utilizza l'adattatore Lightning in dotazione.



Integrated USB cable

- FR > Câble USB intégré
- ES > Cable USB integrado
- DE > integriertes USB-Kabel
- IT > Cavo USB integrato

Velvet pouch included

- FR > Pochette en velours incluse
- ES > Bolsa de terciopelo incluida
- DE > Samttasche inklusive
- IT > Custodia in velluto inclusa

Decoration:

Personalisation / Personalización / Dekoration / Decorazione

TnB® Ultra-slim PowerBank 4000 MFi 09701

- A BP: front, full-colour
- B BPT: front, full-colour

TnB® Ultra-slim PowerBank 4000 mAh 09702

- C BP: front, full-colour
- D BPT: front, full-colour

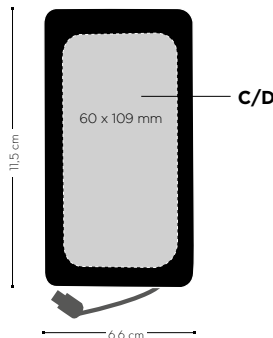
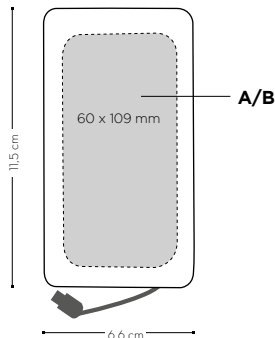

Ultra-slim power bank 4000 mAh with built in micro USB cable. This compact and slim power bank is easy to slip into your suitcase or your bag thanks to its 8 mm thinness. You can triple the autonomy of your smartphone depending on the model. Integrated micro USB cable so that you can recharge it wherever you are. Velvet pouch included.

FR > Batterie externe ultra plate 4000 mAh avec câble micro USB intégré. Cette batterie externe ultra plate et compacte se glissera facilement dans votre sac ou dans votre valise grâce à ses 8 mm d'épaisseur. Vous pouvez tripler l'autonomie de votre smartphone en fonction du modèle. De plus, grâce à son câble micro USB intégré, rechargez-la en un geste, où que vous soyez.

ES > Power bank ultra plano de 4000 mAh con cable micro USB integrado. Este power bank compacto cabe fácilmente en cualquier bolsa o maleta gracias a sus sólo 8 mm de grosor. Puedes llegar a triplicar la autonomía de tu smartphone dependiendo del modelo. Gracias a su cable micro USB integrado puedes recargarlo en cualquier parte.

DE > Ultradünne Power-Bank 4.000 mAh mit eingebautem Mikro-USB-Kabel. Diese kompakte Power-Bank lässt sich dank ihrer schlanken 8mm-Dicke ganz leicht in Ihrem Koffer oder in Ihrer Tasche verstauen. Sie können die Leistung Ihres Smartphones, je nach Modell, verdreifachen. Darüber hinaus können Sie sie dank des integrierten Mikro-USB-Kabels überall wieder aufladen, wo auch immer Sie unterwegs sind.

IT > Caricatore portatile ultrasottile da 4000 mAh con cavo micro USB integrato. Puoi comodamente infilare questo caricatore portatile sottile e compatto nella tua valigia o nella tua borsa, grazie al suo spessore di soli 8 mm. Puoi arrivare a triplicare l'autonomia del tuo smartphone, a seconda del modello. Inoltre, grazie al suo cavo micro USB integrato, puoi ricaricarlo ovunque tu sia.

Printing techniques:

Techniques d'impression / Técnicas de impresión / Drucktechniken / Tecniche di stampa



(BP) britePix™



packaging:

Emballage / Envasado / verpackung / Imballaggio



External packaging:

Emballage externe / Envasado exterior / Außenverpackung / Imballaggio esterno

09701

09702



40 ± 6,6 Kg



40 ± 6,6 Kg





Slim Power Bank 6000 mAh

MOQ 100.



only 15 mm thinness!

FR > Seulement 15 mm d'épaisseur!
ES > Sólo 15 mm de grosor!
DE > Nur 15 mm dünn!
IT > Solo 15 mm di spessore!



USB cable + micro USB integrated

FR > câble USB + micro USB intégré
FR > USB cable + micro USB integrado
DE > USB-Kabel + Mikro-USB integriert
IT > Cavo USB + micro USB integrato

Velvet pouch included

FR > Pochette en velours incluse
ES > Bolsa de terciopelo incluida
DE > Samttasche inklusive
IT > Custodia in velluto inclusa

.30

Decoration:

Personalisation / Personalización /
Dekoration / Decorazione

T'nB® Slim Power Bank 6000 mAh

09703

A BP: front, full-colour

B BPT: front, full-colour

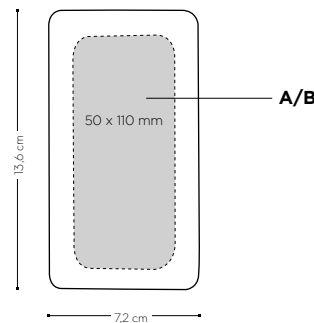

This compact and slim powerbank 6000 mAh is easy to slip into your suitcase or your bag thanks to its thinness of 15mm. You can multiply by 4 the autonomy of your Smartphone (depending on the model). Moreover, thanks to its integrated USB cable + micro USB, recharge the powerbank and your device wherever you are. If you have an iPhone, there is also a USB port available.

FR > Cette batterie nomade slim et compacte 6000 mAh se glissera facilement dans votre sac grâce à sa finesse de 15mm. Vous pouvez quadrupler l'autonomie de votre Smartphone (en fonction du modèle). De plus, grâce à son câble USB + micro USB intégré, rechargez aussi bien la batterie nomade que votre Smartphone et ce où que vous soyez. Si vous possédez un iPhone, utilisez le port USB présent sur le côté.

ES > Este compacto y delgado powerbank de 6000 mAh es fácil de guardar en su maleta o en su bolso gracias a su delgadez de 15 mm. Puede multiplicar por 4 la autonomía de su Smartphone (según el modelo). Además, gracias a su cable USB + micro USB integrado, puedes recargar el dispositivo donde quiera que estés. Si tienes un iPhone, también hay un puerto USB disponible.

DE > Diese kompakte und 15 mm dünne 6000 mAh-Powerbank passt problemlos in Ihren Koffer oder Ihre Handtasche. Sie können damit die Autonomie Ihres Smartphones (je nach Modell) vervierfachen. Darüber hinaus können Sie die Powerbank und Ihr Smartphone über das integrierte USB- und Micro-USB-Kabel überall aufladen. Für iPhone-Besitzer gibt es auch einen speziellen USB-Port.

IT > Questo caricatore portatile e compatto da 6000 mAh è facile da mettere in valigia o in borsa, grazie al suo spessore di soli 15 mm. È possibile quadruplicare l'autonomia del proprio smartphone (a seconda del modello). Inoltre, grazie al suo cavo USB + micro USB integrato, puoi ricaricare il caricatore portatile e il tuo dispositivo ovunque tu sia. Se hai un iPhone, è dotato anche di una porta USB.

Printing techniques:

Techniques d'impression / Técnicas de impresión /
Drucktechniken / Tecniche di stampa



(BP) britePix™



packaging:

Emballage / Envasado /
verpackung / Imballaggio



External packaging:

Emballage externe / Envasado exterior /
Außenverpackung / Imballaggio esterno



40 ± 9,2 Kg



T'nB®
TECHNOLOGY



T'nB® Juke speaker

MOQ 100.



Clear sound in a compact design!

FR > Son net dans un design compact!
 ES > ¡Sonido nítido en un diseño compacto!
 DE > Klarer Klang in kompaktem Design!
 IT > Audio nitido in un design compatto!



100%

.30

Decoration:

Personalisation / Personalización /
 Dekoration / Decorazione

T'nB® Juke speaker

09660

A PD: right top, max. 1 colour

B PD: left top, max. 1 colour

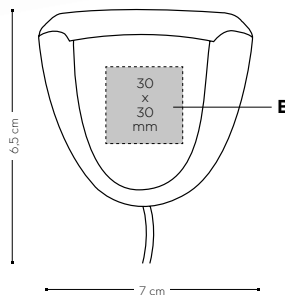
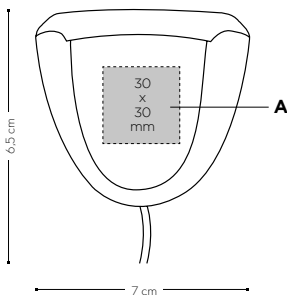

Enhance the sound of the computer with this 2.0 multimedia speaker set with 4W RMS. Compact and original design and USB easy plug and play connection.

FR > Amplifiez le son de votre ordinateur avec ce set de haut-parleurs multimédia 2.0 d'une puissance de 4 W RMS. Design compact et original, avec connexion USB rapide et facile.

ES > Amplifica el sonido de tu ordenador con este set de altavoces multimedia 2.0 con potencia de 4W RMS. Diseño compacto y original, conexión USB rápida y fácil.

DE > Verbessern Sie den Sound Ihres Computers mit diesem 2.0 Multimedia- Lautsprecher set mit 4 W RMS. Kompaktes und originelles Design und USB Plug&Play- Verbindung.

IT > Amplifica il suono del tuo computer con questo set di altoparlanti multimediali 2.0, con una potenza di 4 W RMS. Design compatto e originale con facile connessione USB "plug and play".

Printing techniques:

Techniques d'impression / Técnicas de impresión /
 Drucktechniken / Tecniche di stampa



PAD PRINTING

packaging:

Emballage / Envasado /
 verpackung / Imballaggio



External packaging:

Emballage externe / Envasado exterior /
 Außenverpackung / Imballaggio esterno



20 ± 3,7 Kg

Check out the video

Regardez la video / Mira el video /
 Produktvideo / Guarda il video

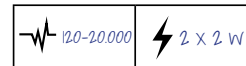

(Until stock lasts) Jusqu'à épuisement du stock / Hasta que se acabe el stock / Solange der Vorrat reicht / Fino a esaurimento scorte



T'nB[®] Art speaker

MOQ 100.



Bluetooth[®] technology, 3 hours autonomy, universal compatibility

FR > Technologie Bluetooth[®], 3 heures d'autonomie, compatibilité universelle.
 ES > Tecnología Bluetooth[®], 3 horas de autonomía, compatibilidad universal.
 DE > Bluetooth[®]-Technologie, 3 Stunden Autonomie, universelle Kompatibilität.
 IT > Tecnologia Bluetooth[®], 3 ore di autonomia, compatibilità universale.

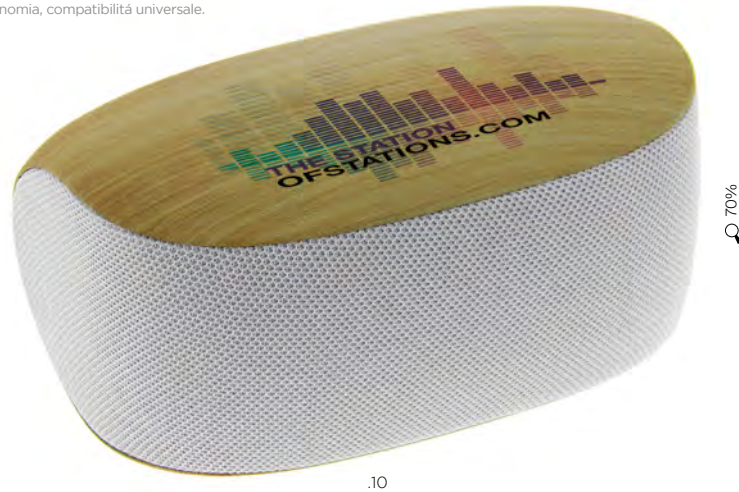

.10

Decoration:

Personalisation / Personalización /
 Dekoration / Decorazione

T'nB[®] Art speaker

09696

A BP: 4-colour process

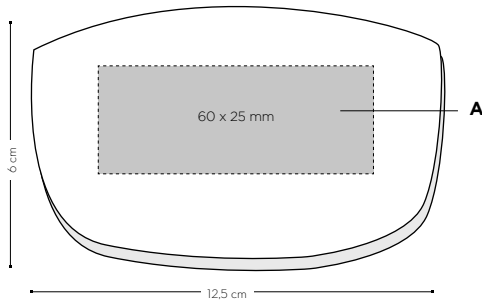

Get seduced by this Bluetooth[®] speaker designed by T'nB[®]. Combining design, trend, sound and technology, the ART collection will be your ideal companion at home or travelling. Amplified quality sound with adjustable bass and treble distribution. Soft touch rubber coating design, a "must-have" for all trendy music addicts.

FR > Laissez-vous séduire par ce modèle d'haut-parleur Bluetooth[®] conçu par T'nB[®]. Alliant à la fois design, tendance, son et technologie, la collection ART vous accompagnera partout chez vous ou en voyage ! Côté son, vous bénéficiez d'une qualité d'écoute amplifiée grâce à un aimant néodyme de 5 watts RMS, offrant une répartition réglable des basses et des aigus. Côté design et matière, ce haut-parleur joue la carte de l'esthétisme scandinave, avec un revêtement en caoutchouc, ultra doux au toucher.

ES > Déjate seducir por este altavoz Bluetooth[®] diseñado por T'nB[®]. La colección ART es una combinación ideal de diseño, moda, sonido y tecnología que te acompañará a todas partes, itanto en casa como en tus viajes! Conseguirás una calidad de sonido amplificada gracias a sus 5W RMS con imán de neodimio y la regulación de agudos y graves ajustable. En cuanto a diseño y material, este altavoz juega un papel decorativo, referencia del espíritu escandinavo, con una superficie de goma que le proporciona un tacto ultra suave.

DE > Lassen Sie sich verführen von diesem Bluetooth[®]-Lautsprecher - design von T'nB[®]. Die ART-Collection vereint Design, Trend, Sound und Technologie und begleitet Sie zu Hause ebenso wie überall auf Reisen! Sie erleben klangvollen Sound dank des 5 Watt-MSNeodym-Magneten mit Bass- und Höhenregulierung. Design und Materialien verkörpern skandinavischen Spirit und Lifestyle. Die rundum gummierte Oberfläche sorgt für ultrasoften Touch.

IT > Lasciati sedurre dal altoparlante Bluetooth[®] progettato da T'nB[®]. La collezione ART è la perfetta sintesi di design, moda, suono e tecnologia e ti accompagnerà ovunque, a casa o in viaggio! In merito al suono, puoi disporre di una qualità audio amplificata, grazie ai magneti in neodimio da 5 watts RMS, con selezione regolabile dei bassi e degli alti. Per quanto riguarda il design e i materiali, questo altoparlante si gioca la carta dello stile, strizzando l'occhio allo spirito scandinavo, grazie al rivestimento in gomma, ultra morbido al tatto.

Printing techniques:

Techniques d'impression / Técnicas de impresión /
 Drucktechniken / Tecniche di stampa



(BP) britePix[™]



packaging:

Emballage / Envasado /
 verpackung / Imballaggio



External packaging:

Emballage externe / Envasado exterior /
 Außenverpackung / Imballaggio esterno



100-20.000	3h	10 m
45 mm NdFeB	5W	

T'nB[®]
 TECHNOLOGY





Sport Bluetooth® speaker Ball

MOQ 100.



09659

Shockproof 3W Bluetooth® speaker ideal for outdoor activities

- FR > Haut-parleur Bluetooth® 3 W résistant aux chocs, idéal pour des activités de plein air.
- ES > Altavoz Bluetooth® 3W a prueba de golpes ideal para actividades al aire libre.
- DE > Stoßfester 3W Bluetooth®-Lautsprecher - ideal für Aktivitäten im Freien.
- IT > Altoparlante Bluetooth® da 3W resistente agli urti, ideale per l'attività all'aria aperta.

Decoration:

Personalisation / Personalización / Dekoration / Decorazione

T'nB® Sport Bluetooth® speaker Ball
09659

A DO: 4-colour process

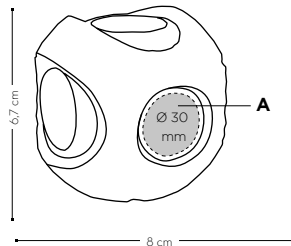

Shockproof 3 watts Bluetooth® speaker. Enjoy your playlist in all conditions, alone or with your friends, without any risk of damaging it. The 6 mm silicone protection helps protect your speaker. Built-in microphone allows you to make phone calls directly from your speaker.

FR > Shockproof 3 watts Bluetooth® speaker. Enjoy your playlist in all conditions, alone or with your friends, without any risk of damaging it. The 6 mm silicone protection helps protect your speaker. Built-in microphone allows you to make phone calls directly from your speaker.

ES > Altavoz Bluetooth® de 3 watts a prueba de golpes. Disfruta de tus listas de reproducción en cualquier tipo de condiciones, solo o con tus amigos, sin riesgo de dañarlo. La protección de silicona de 6 mm de grosor te ayuda a protegerlo. El micrófono incorporado te ofrece la opción de llamar por teléfono directamente desde el altavoz.

DE > Stoßfester 3W Bluetooth®-Lautsprecher. Genießen Sie Ihre Playlists in allen Situationen, alleine oder mit Ihren Freunden, ohne das Risiko einer Beschädigung! Der 6mm-Silikonschutz schützt Ihren Lautsprecher! Mit dem eingebauten Mikrophon können Sie direkt vom Lautsprecher aus telefonieren!

IT > Altoparlante Bluetooth® da 3 W resistente agli urti. Goditi le tue playlist in qualsiasi situazione, da solo o con i tuoi amici, senza rischiare di rovinarlo! Il rivestimento in silicone con uno spessore di 6 mm ti aiuta a proteggerlo. Il microfono incorporato ti offre la possibilità di fare una telefonata direttamente dall'altoparlante.

Printing techniques:

Techniques d'impression / Técnicas de impresión / Drucktechniken / Tecniche di stampa



DOMING

packaging:

Emballage / Envasado / verpackung / Imballaggio



External packaging:

Emballage externe / Envasado exterior / Außenverpackung / Imballaggio esterno



20-20,000	10 m	80
3h	3 W	

Check out the video

Regardez le video / Mira el video / Produktvideo / Guarda il video



T'nB® Vintage Bluetooth® Speaker

MOQ 10V.



09658



Powerful sound in a retro metal casing!

FR > Son puissant avec un boîtier métallique rétro!
 ES > ¡Sonido potente en una carcasa metálica retro!
 DE > Kraftvoller Sound in einem Retro-Metallgehäuse
 IT > Suono potente in una struttura metallica vintage!

Decoration:

Personnalisation / Personalización /
 Dekoration / Decorazione

T'nB® Vintage Bluetooth® Speaker

09658

A L: plate

B L: top left

C L: top right

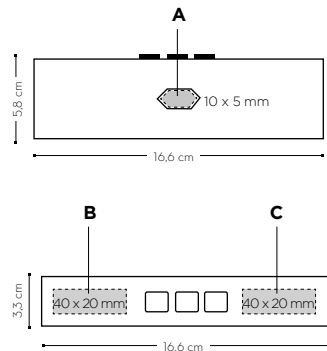

Stylish 2 x 3W Bluetooth® stereo speaker that provides excellent quality sound due to the smart distribution of the basses and the treble. 2.000 mAh rechargeable battery for up to 6 hours playtime. Built-in microphone for hands-free speaker-phone calling. Includes micro USB cable.

FR > Élégant haut-parleur de 2 x 3 W avec Bluetooth® qui offre une excellente qualité de son, grâce à la distribution ingénieuse des sons graves et aigus. Batterie rechargeable de 2 000 mAh pour une durée d'utilisation allant jusqu'à 6 heures. Microphone incorporé pour pouvoir utiliser le haut-parleur en mode mains libres pendant les communications. Câble micro USB inclus.

ES > Elegante altavoz 2 x 3W con Bluetooth® que proporciona una excelente calidad de sonido gracias a la distribución inteligente de los graves y los agudos. Batería recargable de 2.000 mAh para un uso de hasta 6 horas. Microfono incorporado para poder usar el altavoz como manos libres en las llamadas. Incluye cable micro USB.

DE > Stylisher 2 x 3 W Bluetooth® Lautsprecher, der überragende Soundqualität bietet - dank der smarten Ausbreitung der Bässe und Höhen. Der 2000 mAh-Akku garantiert bis zu sechs Stunden Laufzeit. Eingebautes Mikrophon für Freisprech-Telefonate. Inklusive Mikro-USB-Kabel.

IT > Elegante altoparlante 2 x 3 W Bluetooth® con un'ottima qualità del suono grazie alla distribuzione intelligente di bassi e alti. Batteria ricaricabile da 2.000 mAh che garantisce fino a 6 ore di autonomia. Microfono incorporato per chiamate in viva voce. Include cavo micro USB.

Printing techniques:

Techniques d'impression / Técnicas de impresión /
 Drucktechniken / Tecniche di stampa



packaging:

Emballage / Envasado /
 verpackung / Imballaggio



external packaging:

Emballage externe / Envasado exterior /
 Außenverpackung / Imballaggio esterno



30 ± 8,9 Kg

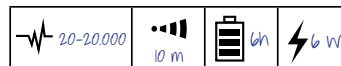

Check out the video

Regardez la video / Mira el video /
 Produktvideo / Guarda il video

T'nB®
 TECHNOLOGY

T'nB® Live in earphones

MOQ 100.



Built-in hands-free kit to pick up the phone while on the go

- FR > Kit mains libres intégré pour décrocher votre téléphone en marchant.
- ES > Kit manos libres integrado para descolgar el teléfono en marcha.
- DE > Eingebaute Freisprecheinrichtung, um Telefonate unterwegs annehmen zu können.
- IT > Kit vivavoce integrato per rispondere al telefono in movimento.



.10

100%

TECHNOLOGY
T'nB®

Decoration:

Personnalisation / Personalización /
Dekoration / Decorazione

T'nB® Live in earphones

09663

A PD: max. 1 col.

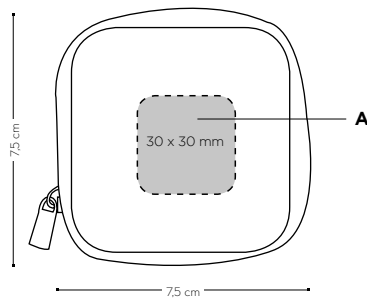

Stereo earphones with hands-free kit. The cable is 120 cm long and sends excellent quality sound to your ear buds. Includes hard case with zip.

FR > Écouteurs stéréo avec kit mains libres. Le câble mesure 120 cm de long et dirige le son d'une très grande qualité vers les écouteurs. Un étui dur avec fermeture à glissière est inclus.

ES > Auriculares estéreo con kit de manos libres. El cable mide 120 cm de largo y dirige el sonido con alta calidad hacia los auriculares. Incluye estuche rígido con cierre de cremallera.

DE > Stereo-Ohrhörer mit Freisprecheinrichtung. 120 cm langes Kabel, das die überragende Soundqualität an die Ohrstecker überträgt. Inklusive verstärkter Tasche mit Reißverschluss.

IT > Auricolari stereo con kit vivavoce. Il cavo ha una lunghezza di 120 cm e convoglia il suono in alta qualità verso gli auricolari. Include una custodia rigida dotata di chiusura con cerniera.

Printing techniques:

Techniques d'impression / Técnicas de impresión /
Drucktechniken / Tecniche di stampa



PAD PRINTING

packaging:

Emballage / Envasado /
verpackung / Imballaggio



External packaging:

Emballage externe / Envasado exterior /
Außenverpackung / Imballaggio esterno



100 ± 7,5 Kg



Check out the video

Regardez la video / Mira el video /
Produktvideo / Guarda il video



T'nB® Steel Bluetooth® Earphones

New!

MOQ 100.

Wireless (Bluetooth® 4.1)

- FR > Wireless (Bluetooth® 4.1)
- ES > Conexión inalámbrica (Bluetooth® 4.1)
- DE > Drahtlos (Bluetooth® 4.1)
- IT > Wireless (Bluetooth® 4.1)



5 hours autonomy of 93 dB

- FR > 5 heures autonomie 93 dB
- ES > 5 horas de autonomía de 93 dB
- DE > 5 Stunden Unabhängigkeit bei 93 dB
- IT > 5 ore di autonomia 93 dB



.31



.01 .27



70%

Decoration:

Personalisation / Personalización / Dekoration / Decorazione

T'nB® Steel Bluetooth® Earphones

09705

A PD: max. 1 col.

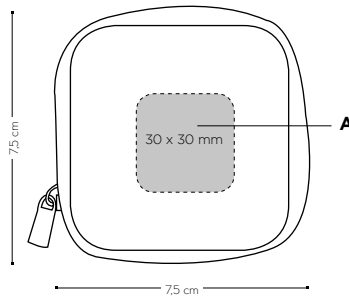

The new STEEL SERIES Bluetooth headphones let you listen to your favorite tunes in complete freedom of movement! The curved metal end caps provide you with optimized support and guarantee unparalleled comfort, without cable between your smartphone and headphones to annoy you, thanks to the wireless system.

FR > Les nouveaux écouteurs Bluetooth STEEL SERIES de T'nB vous permettent d'écouter vos morceaux préférés en toute liberté de mouvement ! En effet, plus de câble entre votre smartphone et vos écouteurs pour vous gêner, grâce au système sans fil ! Les embouts métalliques incurvés vous assurent un maintien optimisé, et vous garantissent un confort inégalé.

ES > Los nuevos auriculares Bluetooth STEEL SERIES te permiten escuchar tus canciones favoritas con total libertad de movimiento. Sus auriculares curvados y metalizados brindan un soporte optimizado y garantizan un confort inigualable. Gracias al sistema de conexión inalámbrico ya no tendrás cables entre tu smartphone y los auriculares que molesten.

DE > "Der neue STEEL SERIES BluetoothKopfhörer läßt Sie Ihre Musik in völliger Bewegungsfreiheit hören! Die gebogenen Endkappen aus Metall bieten Ihnen optimierte Unterstützung und garantieren unvergleichlichen Komfort, ohne Kabel zwischen Ihrem Smartphone und Kopfhörer."

IT > I nuovi auricolari Bluetooth STEEL SERIES ti permettono di ascoltare la tua musica preferita in totale libertà di movimento! Gli auricolari curvati in metallo offrono un supporto ottimizzato e garantiscono un comfort senza pari. Nessun cavo fastidioso tra lo smartphone e gli auricolari grazie al sistema wireless.

Printing techniques:

Techniques d'impression / Técnicas de impresión / Drucktechniken / Tecniche di stampa



PAD PRINTING

packaging:

Emballage / Envasado / verpackung / Imballaggio



external packaging:

Emballage externe / Envasado exterior / Außenverpackung / Imballaggio esterno



50 ± 4 Kg



20-20000	10 m	92
10 mm NdFeB	Ω 32	5h

T'nB® TECHNOLOGY



T'nB Motion Bluetooth® Earphones

New!

MOA 10v.



Magnet closure

FR > Fermeture magnétique
 ES > Cierre magnetico
 DE > Magnetverschluss
 IT > Chiusura magnetica

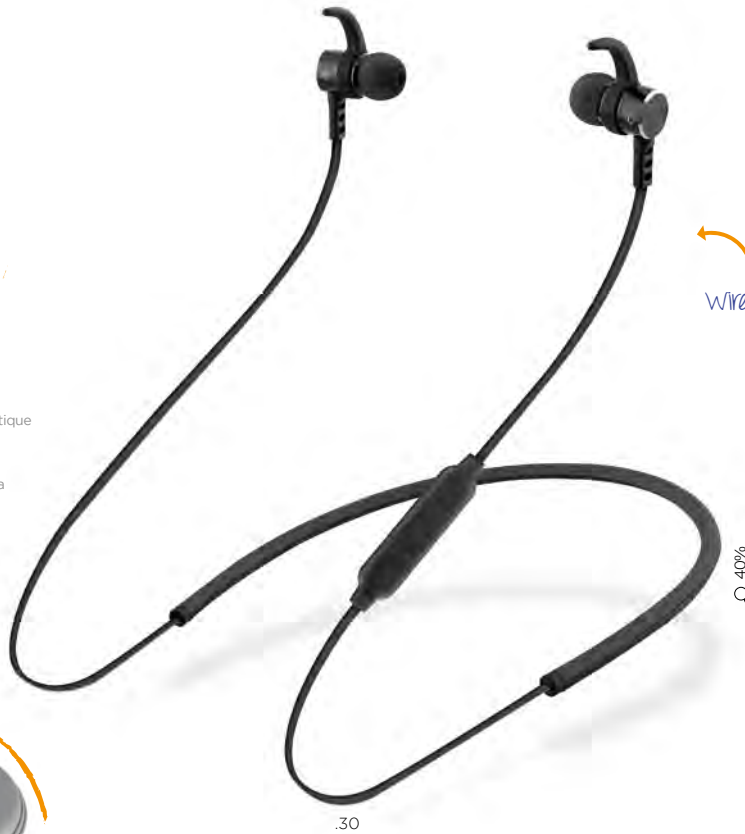

Wireless (Bluetooth® 4.1)

FR > Wireless (Bluetooth® 4.1)
 ES > Conexión inalámbrica (Bluetooth® 4.1)
 DE > Drahtlos (Bluetooth® 4.1)
 IT > Wireless (Bluetooth® 4.1)

40%

.30

Decoration:

Personalisation / Personalización /
 Dekoration / Decorazione

T'nB® Motion Bluetooth® Earphones

09706

A PD: max. 1 col.

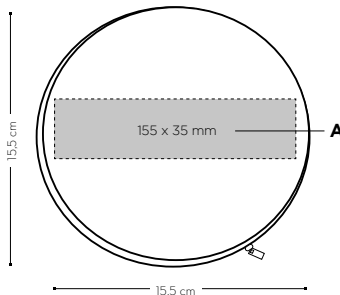

The new sports headphones allow you to practice your sports activities with freedom of movement! Equipped with a remote control with microphone and volume control, access all the options of your smartphone in 1 click without constraint!

The new SPORT Bluetooth headphones from T'nB: the indispensable accessory for all sportsmen.

FR > Les nouveaux écouteurs Bluetooth tour de cou de T'nB vous permettent d'écouter vos morceaux préférés en toute liberté de mouvement ! Les commandes sont directement intégrés au tour de cou (volume, micro, pistes de lecture, interrupteur, charge...) Ces nouveaux écouteurs tour de cou de T'nB sont pratiques à la fois pour une utilisation urbaine comme pour les activités sportives.

ES > Los nuevos auriculares deportivos te permiten practicar tus actividades deportivas con libertad de movimiento! Equipados con un control remoto con micrófono y control de volumen, puede acceder a todas las opciones de su smartphone en 1 click y sin restricciones! Los nuevos auriculares SPORT Bluetooth de T'nB: el accesorio indispensable para todos los deportistas.

DE > The new sports headphones allow you to practice your sports activities with freedom of movement! Equipped with a remote control with microphone and volume control, access all the options of your smartphone in 1 click without constraint! The new SPORT Bluetooth headphones from T'nB: the indispensable accessory for all sportsmen.

IT > The new sports headphones allow you to practice your sports activities with freedom of movement! Equipped with a remote control with microphone and volume control, access all the options of your smartphone in 1 click without constraint! The new SPORT Bluetooth headphones from T'nB: the indispensable accessory for all sportsmen.

Printing techniques:

Techniques d'impression / Técnicas de impresión /
 Drucktechniken / Tecniche di stampa



PAD PRINTING

packaging:

Emballage / Envasado /
 verpackung / Imballaggio



External packaging:

Emballage externe / Envasado exterior /
 Außenverpackung / Imballaggio esterno



40 ± 8 Kg



20-20.000	10 m	92
9 mm NDF2B	Ω 16	3h



T'nB Kids Headphones

MOQ 100.



Volume limited to 85 dB to keep hearing safe

FR > Volume limité à 85 dB pour protéger les oreilles.
 ES > Volumen limitado a 85 dB para mantener los oídos a salvo.
 DE > Auf 85 dB begrenzte Lautstärke - schützt Kinderohren.
 IT > Volume limitato a 85 dB per evitare danni all'udito.

Decoration:

Personnalisation / Personalización /
 Dekoration / Decorazione

T'nB Kids Headphones

09656

A PD: max. 1 col.

B PD: max. 1 col.

C PD: max. 1 col.

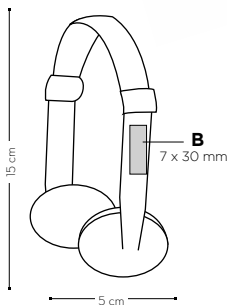
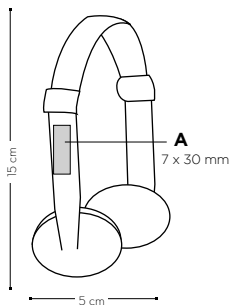

Stereo headphones for children. Sensitivity limited to 85 dB (EU regulations). Suitable for iPod®, MP3/MP4 players, mobile phones, DVD players and video game consoles.

FR > Écouteurs stéréo pour enfants. Sensibilité limitée à 85 dB (règlement européen). Convient à des iPod®, à des lecteurs MP3/MP4, à des téléphones portables, à des lecteurs de DVD et à des consoles de jeux.

ES > Auriculares estéreo para niños. Sensibilidad limitada a 85dB (Regulación Europea). Apto para iPod®, reproductores MP3/MP4, teléfonos móviles, reproductores de DVD y consolas de videojuegos.

DE > Stereo-Kopfhörer für Kinder. Auf 85 dB limitierte Empfindlichkeit (EURichtlinie). Passend für iPod®, MP3/MP4-Player, Mobiltelefone, DVDPlayer und Video-Spielkonsolen.

IT > Cuffie stereo per bambini. Sensibilità limitata a 85 dB (normativa europea). Adatte per iPod®, lettori MP3/MP4, telefoni cellulari, lettori DVD e console per videogiochi.

Printing techniques:

Techniques d'impression / Técnicas de impresión /
 Drucktechniken / Tecniche di stampa



PAD PRINTING

packaging:

Emballage / Envasado /
 verpackung / Imballaggio



external packaging:

Emballage externe / Envasado exterior /
 Außenverpackung / Imballaggio esterno



60 ± 9,4 Kg

Check out the video

Regardez la video / Mira el video /
 Produktvideo / Guarda il video

20-20.000	32	85
1,1 m	27 mm NDF08	



(Until stock lasts) Jusqu'à épuisement du stock / Hasta que se acabe el stock / Solange der Vorrat reicht / Fino a esaurimento scorte

T'nB®
 TECHNOLOGY

T'nB[®] sport Bluetooth[®] Headphones

MOQ 100.



Water resistant Bluetooth[®] 4.0 headphones with rechargeable battery

FR > Écouteurs Bluetooth[®] 4.0 résistants à l'eau avec batterie rechargeable.
 ES > Auriculares Bluetooth[®] 4.0, resistentes al agua y con una batería recargable.
 DE > Wasserabweisender, leistungsstarker Bluetooth[®] 4.0-Kopfhörer mit aufladbarem Akku.
 IT > Auricolari Bluetooth[®] 4.0 resistenti all'acqua con batteria ricaricabile.

60%



80%

.30

Decoration:

Personnalisation / Personalización / Dekoration / Decorazione

T'nB[®] sport Bluetooth[®] Headphones

09667

A PD: case top, max. 1 colour

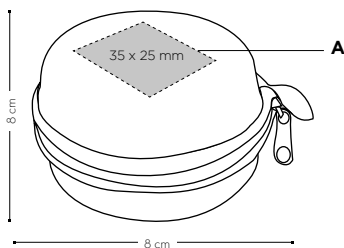

Sport Bluetooth[®] 4.0 headphones. Back of head. With advanced functions (track switch, volume control, pick up / hang up functions).

FR > Écouteurs de sport avec Bluetooth[®] 4.0 qui s'ajustent derrière la tête. Ils sont dotés de fonctions avancées (changement de chanson, contrôle de volume, raccrocher/décrocher).

ES > Auriculares deportivos con Bluetooth[®] 4.0. Se ajustan por detrás de la cabeza. Incluye funciones avanzadas (cambiar canción, controlar volumen, colgar/descolgar).

DE > Sport Bluetooth[®] 4.0 Kopfhörer mit Hinterkopf-Bügel. Mit Zusatzfunktionen (Track-Switch, Lautstärkeregler, Abheben / Auflegen).

IT > Cuffie sportive con Bluetooth[®] 4.0. Si regolano dietro la testa. Dispongono di funzioni avanzate (cambiare canzone, controllare il volume, rispondere/chiedere una chiamata).

Printing techniques:

Techniques d'impression / Técnicas de impresión / Drucktechniken / Tecniche di stampa



PAD PRINTING

packaging:

Emballage / Envasado / verpackung / Imballaggio



External packaging:

Emballage externe / Envasado exterior / Außenverpackung / Imballaggio esterno



50 ± 3,9 Kg



20-20.000	32	105	30 mm NiFeB
10h	10 m		



Check out the video

Regardez la video / Mira el video / Produktvideo / Guarda il video



T'nB® Be Colour Headphones

MOQ 10V.



Enjoy your music with its 105 dB of deep bass!

FR > VProfitez de votre musique avec ses 105 dB de sons graves et profonds!
 ES > ¡Disfruta tu música con sus 105 dB de graves profundos!
 DE > Genießen Sie Ihre Musik mit 105 dB tiefen Bässen!
 IT > Godititi la tua musica preferita grazie ai 105 dB dei bassi più profondi!



Decoration:

Personalisation / Personalización /
 Dekoration / Decorazione

T'nB® Be Colour Headphones

09669

A PD: max. 1 col.

B PD: max. 1 col.

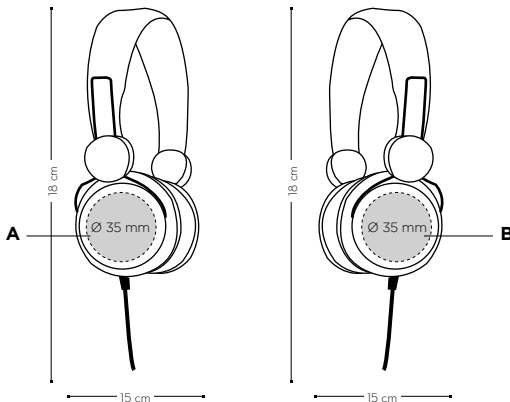

Foldable and adjustable headphones that allow you to listen to all your favorite songs wherever you go with 120 cm cable. Sensitivity up to 105 dB that provides a deep bass and excellent sound quality. Built-in microphone to pick up the phone while on the go. Closed design to block noise from going in and out of the headphones.

FR > Écouteurs pliables et réglables qui vous permettent d'écouter vos chansons préférées, où que vous alliez, grâce au câble de 120 cm de long. Sensibilité jusqu'à 105 dB qui offre des basses profondes et une excellente qualité de son. Microphone incorporé pour décrocher le téléphone en marchant. Design fermé pour empêcher le bruit d'entrer et de sortir des écouteurs.

ES > Auriculares plegables y ajustables que te permiten escuchar tus canciones favoritas vayas donde vayas gracias a su cable de 120 cm de largo. Sensibilidad hasta 105 dB que proporciona bajos graves y una excelente calidad de sonido. Micrófono incorporado para descolgar el teléfono en marcha. De diseño cerrado para limitar el sonido que sale o entra de los auriculares.

DE > Zusammenklappbarer und verstellbarer Kopfhörer, mit dem Sie all Ihre Lieblingsongs mittels eines 120 cm-Kabels hören können. Mit Empfindlichkeit von bis zu 105 dB, liefert der Kopfhörer tiefe Bässe bei exzellenter Soundqualität. Integriertes Mikrophon um Telefonate unterwegs annehmen zu können. Geschlossenes Design, um Umweltgeräusche abzuschirmen und den Sound nicht nach außen dringen zu lassen.

IT > Cuffie con archetto pieghevole e regolabile che ti consentono di ascoltare le tue canzoni preferite ovunque andrai grazie al loro cavo lungo 120 cm. Sensibilità fino a 105 dB che garantisce bassi profondi e un'eccellente qualità del suono. Microfono incorporato per rispondere al telefono in movimento. Design che blocca i rumori impedendogli di entrare e uscire dalle cuffie.

Printing techniques:

Techniques d'impression / Técnicas de impresión /
 Drucktechniken / Tecniche di stampa



PAD PRINTING

packaging:

Emballage / Envasado /
 verpackung / Imballaggio



external packaging:

Emballage externe / Envasado exterior /
 Außenverpackung / Imballaggio esterno

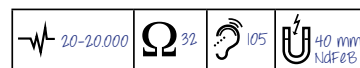

Check out the video

Regardez la video / Mira el video /
 Produktvideo / Guarda il video

T'nB®
 TECHNOLOGY

T'nB® Legend Headphones

MOQ 100.



Vintage atmosphere with the padded velvet ear cushions and reinforced metal structure

FR > Atmosphère vintage avec coussins velours rembourrés, et structure métal renforcée.

ES > Ambiente vintage por sus almohadillas de terciopelo acolchado y estructura metálica reforzada.

DE > Vintage- Atmosphäre mit samtgepolsterten Ohrmuscheln und verstärktem Metallgehäuse.

IT > Un atmosfera vintage con imbottitura in velluto e struttura in metallo.

Decoration:

Personalisation / Personalización / Dekoration / Decorazione

T'nB® Legend Headphones

09694

A BP: left full-colour

B BP: right full-colour

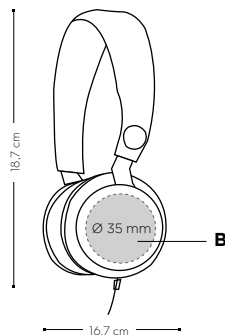
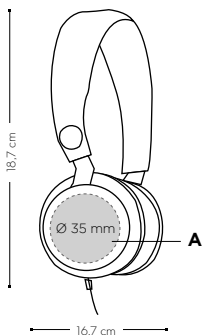

A vintage atmosphere for this new range of headphones with a padded fabric arch, snap buttons, velvet felt foams for listening comfort, aluminum parts, and a braided nylon cable. Clear and precise sound, allowing you to enjoy your favorite music for hours.

FR > Une atmosphère vintage pour cette nouvelle gamme de casque, avec un arceau rembourré, des boutons pression, des mousses en feutrine velours pour un confort d'écoute, des parts en aluminium, et un câble en nylon tressé. Un son clair et précis pour vous permettre d'apprécier votre musique favorite pendant des heures.

ES > Un estilo vintage en la nueva gama de auriculares con un arco de tela acolchada, botones a presión, espumas de filtro de terciopelo para comodidad auditiva, piezas de aluminio y un cable de nylon trenzado. Sonido claro y preciso que le permite disfrutar de su música favorita durante horas.

DE > Einen Hauch von Vintage verkörpert die neue Kopfhörer-Serie mit dem textilmanteltem Bügel, Druckknöpfen, Ohrmuscheln mit Samtpolstern für komfortables Hörerlebnis und einem geflochtenen Nylonkabel. Klarer und präziser Sound. Lauschen Sie Ihrer Lieblingsmusik - stundenlang!

IT > Un atmosfera vintage per questa nuova gamma di cuffie con arco in tessuto imbottito, bottoni a pressione, padiglioni in schiuma ricoperta in velluto per la massima comodità di ascolto, parti in alluminio e un cavo in nylon intrecciato. Un suono nitido e preciso che ti permette di ascoltare la tua musica preferita per ore.

Printing techniques:

Techniques d'impression / Técnicas de impresión / Drucktechniken / Tecniche di stampa



(BP) britePix™



packaging:

Emballage / Envasado / verpackung / Imballaggio



External packaging:

Emballage externe / Envasado exterior / Außenverpackung / Imballaggio esterno



6 ± 2,8 Kg



T'nB® Hashtag Bluetooth® Headphones

New!

MOQ 100.



2 in 1: wired and wireless

FR > 2 en 1: filaire et sans fil
 ES > 2 en 1: inalámbrico y con cable
 DE > 2 in 1: verkabelt und drahtlos
 IT > 2 in 1: con cavo e wireless



4-6 hours autonomy of 115 dB

FR > 4-6 heures autonomie 115 dB
 ES > 4-6 horas de autonomía de 115 dB
 DE > 4-6 Stunden Unabhängigkeit bei 115 dB
 IT > 4-6 ore di autonomia 115 dB



Decoration:

Personnalisation / Personalización /
 Dekoration / Decorazione

T'nB® Hashtag bluetooth® Headphones

09704

A BP: left full-colour
B BP: right full-colour

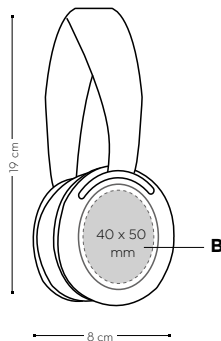
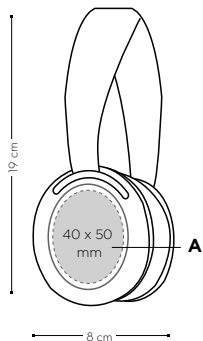

The 2 in 1 headphone: wired and wireless. Bluetooth mode allows total freedom of movement, and works with the built-in Lithium battery. The wired mode (headphone jack included) allows you to use your headset connected directly to the smartphone / MP3 / tablet, in case the battery is discharged.

FR > Le casque 2 en 1: filaire et sans fil. Le mode Bluetooth permet une totale liberté de mouvement, et fonctionne avec la batterie Lithium intégré. Le mode filaire (prise casque incluse sur le casque) permet d'utiliser son casque branché directement sur le smartphone / MP3 / tablette, dans le cas où la batterie est déchargée.

ES > Los auriculares 2 en 1: con cable e inalámbricos. El modo Bluetooth permite total libertad de movimiento y funciona con la batería de litio incorporada. El modo por cable (conector de auriculares incluido) te permite usar los auricular conectados directamente al smartphone / MP3 / tablet, en caso de que la batería esté descargada.

DE > Der 2-in-1-Kopfhörer: verkabelt und drahtlos. Der Bluetooth®-Modus ermöglicht absolute Bewegungsfreiheit und arbeitet mit dem eingebauten Lithium Batterie. Der drahtgebundene Modus (Kopfhöreranschluss ist im Lieferumfang enthalten) ermöglicht, das Ihr Headset direkt mit dem Smartphone / MP3 / Tablet verbunden ist. Die Batterie ist entladen.

IT > Le cuffie 2 in 1: con cavo e wireless. La modalità Bluetooth® consente una totale libertà di movimento e funziona con la batteria al litio integrata. La modalità con cavo (jack per cuffie incluso) ti permette di utilizzare le cuffie collegandole direttamente allo smartphone / MP3 / tablet, nel caso in cui la batteria sia scarica.

Printing techniques:

Techniques d'impression / Técnicas de impresión /
 Drucktechniken / Tecniche di stampa



(BP) britePix™



packaging:

Emballage / Envasado /
 verpackung / Imballaggio



external packaging:

Emballage externe / Envasado exterior /
 Außenverpackung / Imballaggio esterno



50 ± 15,6 Kg



20-20.000	10 m	115
40 mm NiFeB	32 Ω	4-6h

T'nB®
 TECHNOLOGY

T'nB[®] Shine Bluetooth[®] Headphones

MOQ 100.



8 hours autonomy of 82 dB

FR > 8 heures d'autonomie de 82 dB
 ES > 8 horas de autonomía de 82 dB.
 DE > 8 Stunden Unabhängigkeit bei 82 dB
 IT > 8 ore di autonomia 82 dB

4 in 1: Bluetooth[®] wireless, wired, FM radio and SD card!

FR > 4 en 1: Bluetooth[®] sans fil, avec câble, radio FM et carte SD.
 ES > 4 en 1: Bluetooth[®] inalámbrico, con cable, radio FM y tarjeta SD.
 DE > 4 in 1: Bluetooth[®] drahtlos, verkabelt UKW-Radio und SD-Karte!
 IT > 4 in 1: Bluetooth[®] wireless, con cavo, radio FM e scheda SD!

55%

Decoration:

Personnalisation / Personalización /
 Dekoration / Decorazione

T'nB[®] Shine Bluetooth[®] Headphones

09675

A PD: headband left 1 colour

B BP: right full-colour

C BP: left full-colour

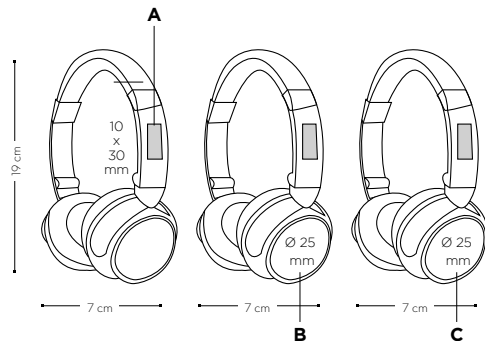

Bluetooth[®] wireless 4-in-1 on-ear foldable headphones with built-in microphone. Up to 8 hours of clear sound provided with a 40 mm NdFeB magnet that can be played from four different sources: Bluetooth[®] 2.1 + EDR wireless, auxiliary cable included or SD card up to 16 GB. Adjustable padded headband and cushioned pads for maximum comfort.

FR > Écouteurs sans fil Bluetooth[®] 4 en 1, pliables et avec microphone incorporé. Profitez jusqu'à 8 heures de 82 dB de son net grâce à l'aimant NdFeB de 40 mm. Vous pouvez reproduire un son à partir de 4 sources différentes: Bluetooth[®] 2.1 + EDR sans câbles, avec le câble auxiliaire inclus, avec la radio FM et avec une carte SD jusqu'à 16 GB. Coussinets et arceau réglable rembourrés pour un plus grand confort.

ES > Auriculares inalámbricos Bluetooth[®] 4 en 1, plegables y con micrófono incorporado. Disfruta hasta 8 horas de 82 dB de sonido nítido gracias al imán NdFeB de 40 mm. Puede reproducir sonido de 4 fuentes distintas: Bluetooth[®] 2.1 + EDR sin cables, con el cable auxiliar incluido, con la radio FM o con una tarjeta SD de hasta 16GB. Almohadillas y diadema ajustable acolchadas para mayor confort.

DE > Kabelloser Bluetooth[®] 4-in-1 faltbarer Kopfhörer mit integriertem Mikrofon. Bis zu 8 Stunden klaren 82 dB-Sounds, von einem 40 mm NdFeB-Magneten erzeugt, kann von vier verschiedenen Quellen angesteuert werden: kabellos mit Bluetooth[®] 2.1+EDR, kabelgebunden mit beliebigem Audiokabel, FM-Radio oder SD-Karte bis zu 16 GB. Verstellbarer, verstärkter Kopfbügel und gepolsterte Ohrmuscheln für maximalen Komfort.

IT > Cuffie wireless Bluetooth[®] 4 in 1, pieghevoli e con microfono integrato. Goditi fino a 8 ore di suono nitido a 82 dB, grazie al magnete dell'altoparlante al neodimio da 40 mm. Può riprodurre l'audio da 4 fonti diverse: dal Bluetooth[®] 2.1 + EDR wireless oppure collegato al cavo ausiliario incluso, dalla radio FM o dalla scheda SD fino a 16 GB. Padiglioni e archetto regolabile imbottiti per il massimo confort.

Printing techniques:

Techniques d'impression / Técnicas de impresión /
 Drucktechniken / Tecniche di stampa



PAD PRINTING



(BP) britePix™



packaging:

Emballage / Envasado /
 verpackung / Imballaggio



External packaging:

Emballage externe / Envasado exterior /
 Außenverpackung / Imballaggio esterno



6 ± 2.4 Kg



T'nB® Active Noise Reduction Headphones

MOQ 100.



Active noise cancelling technology, wireless and 150cm auxiliary cable

FR > Technologie active de suppression de bruits, Bluetooth® mais si besoin cable de 1.5 m.

ES > Tecnología activa de bloqueo de ruido y auriculares inalámbrico de 1,5 m.

DE > Kopfhörer mit aktiver Technologie zur Unterdrückung der Umgebungsgeräusche und 10 m Reichweite.

IT > Tecnologia attiva di riduzione del rumore e cavo ausiliario da 1,5 m.

30

Decoration:

Personalisation / Personalización / Dekoration / Decorazione

T'nB® Active Noise Reduction Headphones

09695

A BP: full-colour

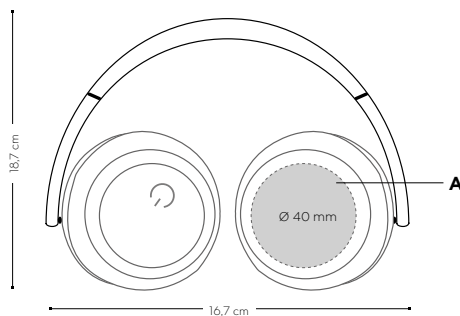

Premium stereo headset features active noise reduction technology to eliminate any noise barriers between you and your music. Discover a world without noise. With a single push of a button, the noises disappear to leave room for music. Ideal for travellers, the Active noise reduction headset comes with an airplane adapter. The supra-aural headset is foldable and its headphones are rotating.

FR > Casque stéréo premium avec technologie de réduction de bruits active pour éliminer tout obstacle sonore entre vous et votre musique. D'une simple pression sur un bouton, les bruits disparaissent pour laisser la place à la musique. Idéal pour les voyageurs, le casque avec réduction de bruits Active est livré avec un adaptateur avion. Le casque supra-aural est pliable et ses écouteurs sont rotatifs.

ES > Auriculares estéreo de primera calidad con tecnología de reducción de ruido activa para eliminar cualquier barrera de ruido entre tú y la música. Descubre un mundo sin ruido. Con solo presionar un botón, los ruidos desaparecen para dejar espacio a la música. Ideal para viajeros, los auriculares de reducción de ruido vienen con un adaptador de avión. El auricular supra-aural es plegable y sus auriculares son giratorios.

DE > Premium Stereo-Kopfhörer mit aktiver Technologie zur Unterdrückung der Umgebungsgeräusche. Jedes störende Geräusch zwischen Ihnen und Ihrer Musik wird abgeschirmt. Entdecken Sie eine Welt ohne Lärm. Mit einem einzigen Knopfdruck lassen sich die Geräusche ausschalten, um Raum für Musik zu schaffen. Ideal für Reisende: Das Active Noise Reduction-Headset ist mit einem Flugzeug-Adapter. Das ohrauffliegende Headset ist faltbar, und die Hörmuscheln sind drehbar. Mitgeliefert wird ein abnehmbares Audiokabel.

IT > Cuffie stereo premium con tecnologia attiva di riduzione del rumore per eliminare qualunque disturbo tra te e la tua musica. Scopri un mondo senza rumore. Premendo semplicemente un bottone, i rumori spariscono per lasciare spazio alla musica. Ideale per i viaggiatori, le cuffie con riduzione attiva del rumore, sono fornite di adattatore per aereo. Le cuffie supra-aural sono ripieghevoli e hanno gli auricolari rotanti.

Printing techniques:

Techniques d'impression / Técnicas de impresión / Drucktechniken / Tecniche di stampa



(BP) britePix™



packaging:

Emballage / Envasado / verpackung / Imballaggio



external packaging:

Emballage externe / Envasado exterior / Außenverpackung / Imballaggio esterno



6 ± 3,1 Kg



T'nB® TECHNOLOGY

T'nB[®] HD Action camera

MOQ 100.



.30

80%

Water-resistant, 90 minutes of battery autonomy

- FR > Résistant à l'eau, 90 minutes d'autonomie de la batterie.
- ES > Resistente al agua, 90 minutos de autonomía de la batería.
- DE > Wasserabweisend, 90 Minuten Batterieleistung.
- IT > Water-resistant, con 90 minuti di autonomia.

Decoration:

Personalisation / Personalización / Dekoration / Decorazione

T'nB[®] HD Action camera

09686

A BP: full-colour

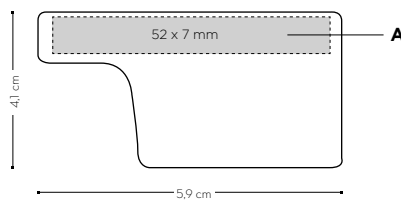

Take videos and pictures of your adventures with this quality 720p action camera. Micro HDMI and micro USB connections. Maximum capacity of 32 GB (using a micro-SD card, not included). Waterresistant up to 60 meters, user manual and 7 different holding accessories.

FR > Prenez des vidéos et des photographies de vos aventures avec cette caméra d'action 720p. Connexions micro HDMI et micro USB. Capacité maximale de 32 Go (avec une carte micro-SD, non incluse). Livrée avec boîtier résistant à l'eau jusqu'à 60 mètres, câble micro USB, manuel de l'utilisateur et 7 accessoires de maintien différents.

ES > Graba vídeos y saca fotos de tus aventuras con esta cámara de acción de 720p. Conexiones micro HDMI y micro USB. La capacidad máxima es de 32 GB (usando una tarjeta micro SD -no incluida-). Incluye carcasa sumergible hasta 60 metros, cable micro USB, manual de instrucciones y 7 accesorios de sujeción distintos.

DE > Halten Sie Ihre Abenteuer in Videos und Fotos mit dieser qualitativ hochwertigen 720p Action-Kamera fest. Mikro-HDMI und Mikro-USB-Verbindungen. Maximale Speicherkapazität von 32 GB (mit Mikro-SD-Karte - nicht enthalten). Mit bis zu 60 m wasserresistenter Tasche, Mikro-USB-Kabel, Bedienungsanleitung und 7 verschiedenen Zubehörteilen.

IT > Gira filmati e scatta foto delle tue avventure con questa action camera ad alta definizione 720p. Connessioni micro HDMI e micro USB. Capacità massima di memoria di 32 GB (con una card micro-SD, non inclusa). Dotata di involucro impermeabile fino a 60 metri di profondità, cavo micro USB, manuale di istruzioni e 7 diversi accessori di supporto.

Printing techniques:

Techniques d'impression / Técnicas de impresión / Drucktechniken / Tecniche di stampa



(BP) britePix™



packaging:

Emballage / Envasado / verpackung / Imballaggio



External packaging:

Emballage externe / Envasado exterior / Außenverpackung / Imballaggio esterno



2 ± 0,9 Kg



T'nB® 4K Action camera

MOQ 100.



Make your movies as exciting as your stunts thanks to the 4K quality!

- FR > Faites des vidéos aussi excitantes que vos aventures grâce à la qualité 4K!
- ES > ¡Haz vídeos tan emocionantes como tus aventuras gracias a la calidad 4K!
- DE > Gestalten Sie mit der 4K-Qualität aufregende Videos, Stunts etc.!
- IT > Potrai rivivere le emozioni delle tue avventure grazie alla qualità 4K dei filmati!

Decoration:

Personalisation / Personalización /
Dekoration / Decorazione

T'nB® 4K Action camera

09685

A BP: full-colour

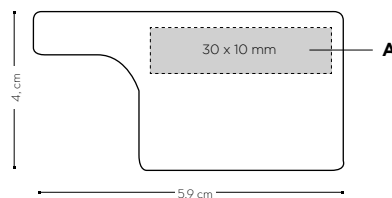

Real 4K video resolution, 16 megapixel CMOS. This action camera will make your adventures just as exciting on screen as in real life. WiFi, micro HDMI and micro USB connections. Built-in microphone. Maximum capacity of 32 GB (using a micro-SD card, not included). Water-resistant up to 60 meters, user manual and 12 different holding accessories.

FR > Caméra, résolution 4K et capteur CMOS 16 mégapixel. Cette caméra d'action rendra vos aventures aussi excitantes à l'écran que dans la vie réelle. WiFi, connexions pour micro HDMI et micro USB. Capacité maximum de la SD-card de 32 GB (utilisez une micro-SD non incluse). Waterproof jusqu'à 60 mètres, manuel d'utilisation et 12 accessoires différents de fixation.

ES > Resolución de video 4K real, sensor CMOS de 16 megapíxeles. Esta cámara de acción hará que tus aventuras sean tan emocionantes en pantalla como en la vida real. WiFi y conexiones micro HDMI y micro USB. Micrófono integrado. La capacidad máxima es de 32 GB (usando una tarjeta micro SD no incluida). Resistente al agua hasta 60 metros, manual de instrucciones y 12 accesorios de sujeción distintos.

DE > Reale 4K Video-Auflösung, 16 Megapixel CMOS und 170° Weitwinkelobjektiv. Diese Action-Camera wird Ihre Abenteuer auf dem Bildschirm ebenso spannend wiedergeben wie sie im echten Leben passiert sind! 2 Zoll TFT-LCD-Bildschirm an der Rückseite, so dass Sie Ihre Videos sofort anschauen können. Genießen Sie bis zu 90 Minuten Akkulaufzeit des herausnehmbaren Lithium-Ionen-Akkus. WiFi, Mikro-HDMI und Mikro-USB-Anschluss. Integriertes Mikrofon. Maximale Speicherkapazität von 32 GB (mit Mikro-SD-Karte nicht enthalten). Mit bis zu 60 m wasserresistenter Tasche, Mikro-USB-Kabel, Bedienungsanleitung und 12 verschiedenen Zubehörtellen.

IT > Risoluzione video reale 4K, 16 megapixel CMOS. Questa action camera renderà le tue avventure nello schermo eccitanti quanto nella vita reale. WiFi, connessioni micro HDMI e micro USB. Microfono incorporato. Massima capacità di 32 GB (usando una micro-SD non inclusa). Water resistant fino a 60 metri, manuale d'istruzione e 12 differenti accessori inclusi.

Printing techniques:

Techniques d'impression / Técnicas de impresión /
Drucktechniken / Tecniche di stampa



(BP) britePix™



packaging:

Emballage / Envasado /
verpackung / Imballaggio



external packaging:

Emballage externe / Envasado exterior /
Außenverpackung / Imballaggio esterno



2 ± 1,2 Kg



Check out the video

Regardez la vidéo / Mira el video /
Produktvideo / Guarda il video



FR > SKROSS® est une marque suisse leader depuis de nombreuses années en solutions innovantes pour les voyageurs.

SKROSS® is a Swiss company which has been the market leader for many years in providing innovative solutions for mobile travellers.

ES > SKROSS® es una marca suiza la cual ha sido marca líder en el mercado durante muchos años suministrando soluciones innovadoras para viajeros móviles.

DE > SKROSS® ist eine Marke aus der Schweiz und seit vielen Jahren Marktführer in Sachen innovative Lösungen für mobile Reisende.

IT > SKROSS® è un marchio svizzero, leader del settore ormai da molti anni nel fornire soluzioni innovative per chi deve viaggiare.



TECHNOLOGY
SKROSS®





SKROSS®
ADAPT TO THE WORLD

World To Europe USB

MOA 10v.



The whole world at home in Europe!

FR > iEl mundo entero en casa, en Europa!
ES > The whole world at home in Europe!
DE > Die ganze Welt in Europa zu Hause!
IT > Tutto il mondo a casa, in Europa!



100%



.10

Decoration:

Personnalisation / Personalización /
Dekoration / Decorazione

World To Europe USB

*USB 09677

A PD: max. 2 col.

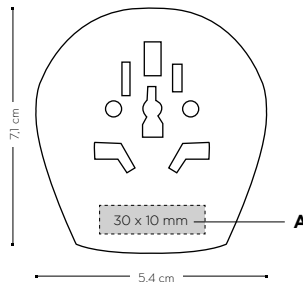

An easy, reliable connection to the European standard plug for devices from all over the world, with built-in USB charger that can be used at the same time. Suitable for equipment with earthed and unearthed plugs (2 and 3 poles) and USB devices. Receptacles for: Switzerland, Italy, Australia/China, UK, USA/Japan and Brazil.

FR > Connexion facile et fiable à la prise standard européenne pour les dispositifs du monde entier, avec chargeur USB incorporé pouvant être utilisé simultanément. Convient pour des équipements avec des prises raccordées ou non à la terre (à 2 et 3 pôles) et des dispositifs USB. Entrées pour : Suisse, Italie, Australie/Chine, Royaume-Uni, USA/Japon et Brésil.

ES > Conexión fácil y fiable al enchufe estándar europeo para dispositivos de todo el mundo, con cargador USB integrado que se puede usar al mismo tiempo. Apto para equipamiento con enchufes con y sin toma de tierra (de 2 y 3 polos) y dispositivos USB. Entradas para Suiza, Italia, Australia/China, Reino Unido, EEUU/Japón y Brasil.

DE > Zuverlässige und einfache Verbindung für Geräte aus der ganzen Welt mit dem europäischen Normstecker, inkl. integriertem USB-Ladegerät für zeitgleiche Verwendung. Geeignet für geerdete und ungeerdete Stecker (2- und 3-polig) sowie USB-Geräte. Steckdoseingang für: Schweiz, Italien, Australien/China, UK, USA/Japan und Brasilien.

IT > Collegarsi alle prese standard europee con dispositivi internazionali è semplice e affidabile; con caricabatterie USB integrato, che puoi usare contemporaneamente. Adatto per apparecchiature dotate di spine con e senza messa a terra (a 2 e 3 poli) e dispositivi USB. Spine per Svizzera, Italia, Australia/Cina, Regno Unito, USA/Giappone e Brasile.

Printing techniques:

Techniques d'impression / Técnicas de impresión /
Drucktechniken / Tecniche di stampa



PAD PRINTING

packaging:

Emballage / Envasado /
verpackung / Imballaggio



External packaging:

Emballage externe / Envasado exterior /
Außenverpackung / Imballaggio esterno



50 ± 3 Kg

Check out the video

Regardez la vidéo / Mira el vídeo /
Produktvideo / Guarda il video



SKROSS®
TECHNOLOGY

MOQ 100.



The smallest 3-pole world travel adapter with built-in USB charger!

FR > Le plus petit des adaptateurs de voyage à 3 pôles, et avec chargeur USB intégré !

DE > Der kleinste 3-polige Welt-Reiseadapter mit integriertem USB-Ladegerät!

ES > El adaptador de viaje de 3 polos más pequeño con cargador USB integrado!

IT > Il più piccolo adattatore da viaggio a 3 poli, con caricabatterie US integrato!

120%

.10

Decoration:

Personalisation / Personalización / Dekoration / Decorazione

Pro Light USB

*USB 09678

A PD: max. 2 col.

B PD: max. 2 col.

C PD: max. 2 col.

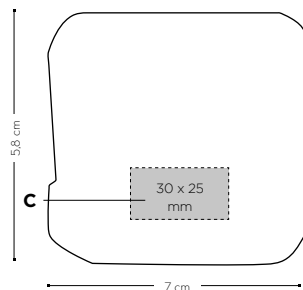
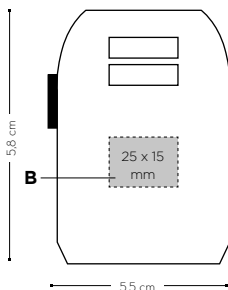
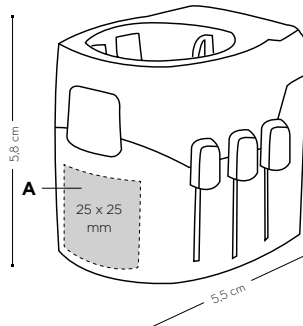

Ultra compact 3-pole travel adapter that can be used in over 100 countries and functions as both a travel plug and USB charger for travellers from Europe. Suitable for connecting powerful devices such as laptops or travel hairdryers and charging two smartphones via USB at the same time.

FR > Adaptateur de voyage à 3 pôles ultra-compact pouvant être utilisé dans plus de 100 pays et servant aussi bien de prise de voyage que de chargeur USB pour les voyageurs européens. Convient pour connecter des dispositifs puissants tels que portables ou sèchecheveux de voyage, et pour charger deux smartphones en même temps via USB.

DE > Ultra kompakter 3-poliger Reiseadapter für über 100 Länder, der sowohl als Reisestecker, als auch als USB-Ladegerät für Reisende aus Europa dient. Geeignet, um ein leistungsstarkes Gerät wie Laptop oder Reisehaartrockner anzuschließen und gleichzeitig zwei Smartphones über USB zu laden.

ES > Adaptador de viaje de 3 polos ultracompacto que puede usarse en más de 100 países y que funciona tanto como enchufe de viaje, como cargador USB para viajeros europeos. Apto para conectar dispositivos potentes como portátiles o secadores de pelo de viaje y cargar via USB dos smartphones al mismo tiempo.

IT > Adattatore da viaggio a 3 poli ultracompatto, utilizzabile in più di 100 paesi, funziona sia come spina da viaggio, sia come caricabatterie USB per i viaggiatori europei. Adatto per collegare alla corrente dispositivi potenti come notebook o asciugacapelli viaggio e, allo stesso tempo, ricaricare tramite USB due smartphone.

Printing techniques:

Techniques d'impression / Técnicas de impresión / Drucktechniken / Tecniche di stampa



PAD PRINTING

packaging:

Emballage / Envasado / verpackung / Imballaggio



external packaging:

Emballage externe / Envasado exterior / Außenverpackung / Imballaggio esterno



50 ± 7,2 Kg

MOA 10v.



Decoration:

Personnalisation / Personalización /
Dekoration / Decorazione

World Adapter MUV USB

*USB 09474

A PD: max. 2 col.

B PD: max. 2 col.

C PD: max. 2 col.

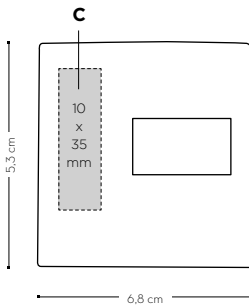
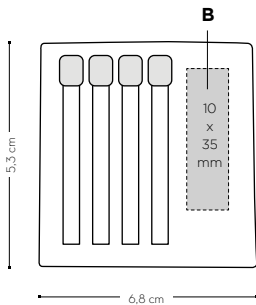
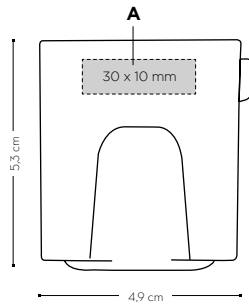

This innovative 2-pole adapter can be used in over 220 countries and functions as both as travel plug and USB charger. It can connect simultaneously one unearthed 2-pole-plug and two USB devices with a rich charging output of 2400 mA shared.

FR > Cet adaptateur innovant à 2 pôles peut être utilisé dans plus de 220 pays et sert à la fois d'adaptateur de voyage et de chargeur USB. Grâce à la grande capacité de charge de sa batterie (2400 mA), vous pouvez brancher en même temps un appareil équipé d'une prise à 2 pôles et deux appareils USB.

ES > Este innovador adaptador de 2 polos puede usarse en más de 220 países y funciona como enchufe de viaje y como cargador USB a la vez. Puede conectar simultáneamente un enchufe de 2 polos sin toma de tierra y dos dispositivos USB gracias a su alta capacidad de carga de 2400 mA.

DE > Dieser innovative 2-polige Adapter kann in über 220 Ländern als Reisestecker und USB-Ladegerät eingesetzt werden. Er stellt 2400 mA Ladepower bereit und kann damit zeitgleich zwei USB-Geräte aufladen, und einen ungeerdeten 2-poligen Stecker verbinden.

IT > Questo innovativo adattatore a due poli può essere usato in più di 220 paesi e funziona come caricatore da viaggio e caricatore USB contemporaneamente. Con una carica di 2400 mA permette di collegare simultaneamente una spina a 2 poli e due dispositivi USB.

Printing techniques:

Techniques d'impression / Técnicas de impresión /
Drucktechniken / Tecniche di stampa



PAD PRINTING

packaging:

Emballage / Envasado /
verpackung / Imballaggio



External packaging:

Emballage externe / Envasado exterior /
Außenverpackung / Imballaggio esterno



50 ± 11,8 Kg



Packaging

LIGHTERS SPECIAL PACKAGING

- 357 Box of 50 Metal Styl'it Case
- 357 Count Box 10u Cases

WRITING INSTRUMENTS SPECIAL PACKAGING

- 357 BIC® Cotton drawstring pouch
- 356 Black Two-Piece Gift Box
- 355 Black Velvet Pouch
- 355 Carton Black & Silver colour gift box
- 355 Cello Wrap
- 357 Count Box
- 355 Frosted Pouch
- 356 Hinged Gift Box
- 357 Plastic Bag
- 356 See-Through Gift Box
- 357 Tray of 10 writing instruments

Cello wrap



Price (€)

1 unit	0,15
2 units	0,30
3 units	0,45
4 units	0,60

Not available for graphite pencils or metal pens.
 Due to different printing processes, the imprint colours on pens and notepads may slightly differ.
 Non disponible pour les crayons à papier ni pour les stylos en métal.
 En raison des différents procédés d'impression, les couleurs de marquage sur les stylos et les bloc-notes peuvent être légèrement différents.
 No disponible para lápices de grafito o bolígrafos de metal.
 Debido a los diferentes procesos de impresión, los colores de impresión en bolígrafos y blocs de notas pueden ser ligeramente diferentes.
 Nicht verfügbar für Druckbleistift und Metallkugelschreiber.
 Aufgrund unterschiedlicher Druckverfahren kann es zu leichten Farbabweichungen auf den Kugelschreibern und Notizblöcken kommen.
 Non disponibile per matite in grafite né per penne metalliche.
 Per via delle differenti tecniche di stampa, i colori stampati sulle penne e sui blocchi note potrebbero risultare leggermente diversi.

Frosted Pouch (for 1 or 2 items)

A SP: max. 1 col.

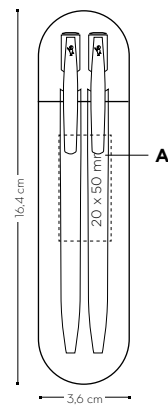

(SP) SCREEN PRINTING

Price (€)

	0,79
ADDITIONAL IMPRINT CHARGE PER COLOUR & POSITION SP	0,45

Available for 1 or 2 (slim) BIC® writing instruments except: graphite pencils, BIC® Matic® Grip.
 Disponible pour 1 ou 2 (slim) BIC® instruments d'écriture, à l'exception des crayons à papier et du BIC® Matic® Grip.
 Disponible para 1 o 2 (slim) instrumentos de Escritura BIC®.
 Verfügbar für 1 oder 2 (Slim) BIC® Schreibgeräte, ausgenommen Druckbleistift BIC® Matic® Grip.
 Disponibile per 1 o 2 strumenti di scrittura (sottili) BIC® eccetto: matite in grafite, BIC® Matic® Grip.

Black Velvet Pouch 1 item

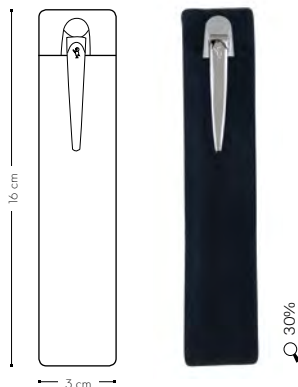

Black Velvet Pouch for Set

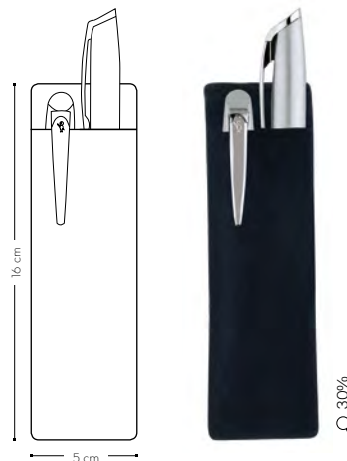

Price (€)

1 item	0,47
for Set	0,79

Available for all writing instruments, except graphite pencils.
 Disponible pour tous les instruments d'écriture à l'exception des crayons à papier.
 Disponible para todos instrumentos de escritura, excepto lápices de grafito.
 Verfügbar für alle Schreibgeräte, ausgenommen Druckbleistift.
 Disponibile per tutti gli strumenti di scrittura eccetto matite in grafite.

Carton Black & Silver colour gift box

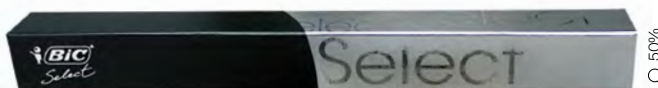

Price (€)

	0,30
--	------

Available for all writing instruments, except graphite pencils.
While stock lasts
 Disponible pour tous les instruments d'écriture à l'exception des crayons à papier. Jusqu'à épuisement des stocks.
 Disponible para todos instrumentos de escritura, excepto lápices de grafito. Hasta fin de existencias.
 Verfügbar für alle Schreibgeräte, ausgenommen Druckbleistift. Solange der Vorrat reicht.
 Disponibile per tutti gli strumenti di scrittura eccetto matite in grafite. Fino a esaurimento scorte.

Black Two Piece Gift Box for 1 item

A SP: max. 1 col.



Price (€)

1,20

ADDITIONAL IMPRINT CHARGE PER COLOUR & POSITION

SP 0,45

Available for all writing instruments, except graphite pencils.
 Disponible pour tous les instruments d'écriture à l'exception des crayons à papier.
 Disponible para todos instrumentos de escritura, excepto lápices de grafito.
 Verfügbar für alle Schreibgeräte, ausgenommen Druckbleistifte.
 Disponibile per tutti gli strumenti di scrittura eccetto matite in grafite.



(SP) SCREEN PRINTING

Black Two Piece Gift Box for set



Price (€)

2,00

Available for all writing instruments, except graphite pencils.
Only available unprinted.
 Disponible pour tous les instruments d'écriture à l'exception des crayons à papier. Uniquement disponible sans marquage.
 Disponible para todos instrumentos de escritura, excepto lápices de grafito. Solo disponible sin impresión.
 Verfügbar für alle Schreibgeräte, ausgenommen Druckbleistifte. Nur unbedruckt erhältlich.
 Disponibile per tutti gli strumenti di scrittura eccetto matite in grafite. Disponibile solo non stampato

Hinged Gift Box (for 1 or 2 items)

A BP: full-colour

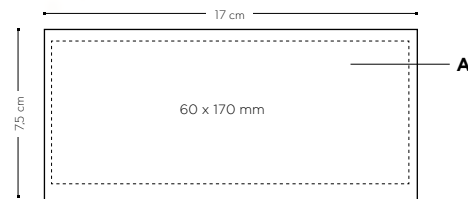

Price (€)

2,60

ADDITIONAL IMPRINT CHARGE PER COLOUR & POSITION

BP 0,95

Available for all writing instruments, except graphite pencils.
 Disponible pour tous les instruments d'écriture à l'exception des crayons à papier.
 Disponible para todos instrumentos de escritura, excepto lápices de grafito.
 Verfügbar für alle Schreibgeräte, ausgenommen Druckbleistifte.
 Disponibile per tutti gli strumenti di scrittura eccetto matite in grafite.



(BP) britePix™



See-Through Gift Box (for 1 or 2 items)



Price (€)

1,79

Available for all writing instruments, except graphite pencils.
 Disponible pour tous les instruments d'écriture à l'exception des crayons à papier.
 Disponible para todos instrumentos de escritura, excepto lápices de grafito.
 Verfügbar für alle Schreibgeräte, ausgenommen Druckbleistifte.
 Disponibile per tutti gli strumenti di scrittura eccetto matite in grafite.

Cotton Drawstring pouch

A SP: max. 2 col.
A OT: full-colour

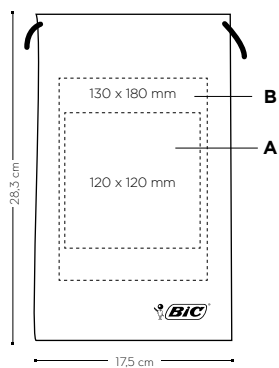

15%

	50-99	100-249	250-499	500-999	1000-2499	2500-4999	5000-9999
Unimprinted	2,10	2,10	2,10	2,10	2,10	2,10	2,10
SP	-	-	-	2,97	2,82	2,76	2,75
OT	-	-	-	3,90	3,72	3,65	3,64

Available for all writing instruments, except graphite pencils.
Disponible pour tous les instruments d'écriture à l'exception des crayons à papier.
Disponibile para todos instrumentos de escritura, excepto lápices de grafito.
Verfügbar für alle Schreibgeräte, ausgenommen Druckbleistifte.
Disponibile per tutti gli strumenti di scrittura eccetto matite in grafite.



(SP) SCREEN
PRINTING



(OT) OFFSET
TRANSFER

Count Box

Small
(for 25 BIC® Media Clic)
Medium
(for 50 BIC® Media Clic or similar)
Large
(only for 100 BIC® Ecolutions®
Evolution)

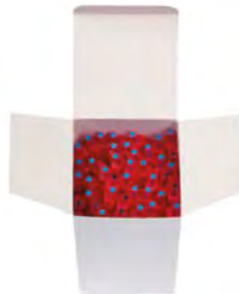

Price (€)

Small	0,75
Medium	1,05
Large	1,45

Plastic Bag

Small
(for 25 BIC® Media Clic or similar)
Medium
(for 50 BIC® Media Clic or similar)
Large
(for 100 BIC® Media Clic or similar)



Price (€)

Small	0,50
Medium	1,00
Large	1,50

Tray of 10 writing instruments



Price (€)

1,68

Count Box 10v Cases



Price (€)

0,87

Count Box 10v Cases Child Resistant



Price (€)

0,87

Count Box 10v J25 Child Resistant



Price (€)

0,68

Box of 50 Metal Styl'it Case Resistant



Price (€)

3,95

Available for BIC® Styl'it Luxury Lighter Case family and BIC® Aluminium Flat Case.
Disponible pour la famille des BIC® Styl'it Luxury Lighter Case et des BIC® Aluminium Flat Case.
Disponibile para la familia BIC® Styl'it Luxury Lighter Case y BIC® Aluminium Flat Case.
Verfügbar für BIC® Styl'it Luxury Lighter Case family and BIC® Aluminium Flat Case.
Disponibile per la famiglia BIC® Styl'it Luxury Lighter Case family e BIC® Aluminium Flat Case.

Available for BIC® J26, BIC® J38 and BIC® J39 Lighter.
Disponible pour les briquets BIC® J26, BIC® J38 et BIC® J39.
Disponibile para los encendedores BIC® J26, BIC® J38 y BIC® J39 Lighter.
Verfügbar für BIC® J26, BIC® J38 und BIC® J39 Lighter.
Disponibile per gli accendini BIC® J26, BIC® J38 e BIC® J39.

Available for BIC® J25 lighter.
Disponible pour le briquet BIC® J25.
Disponible para el encendedor BIC® J25.
Verfügbar für BIC® J25 lighter.
Disponibile per accendino BIC® J25.

Available for BIC® Clip Case, BIC® Styl'it Fashion Case and BIC® 3D Case.
Disponible pour les coques BIC® Clip Case, BIC® Styl'it, Fashion Case et BIC® 3D Case.
Disponibile para BIC® Clip Case, BIC® Styl'it Fashion Case y BIC® 3D Case.
Verfügbar für BIC® Clip Case, BIC® Styl'it Fashion Case und BIC® 3D Case.
Disponibile per BIC® Clip Case, BIC® Styl'it Fashion Case e BIC® 3D Case.

FR> Service d'impression en 48 heures

Gratuit sur plus de 100 produits BIC®!

Conditions préalables du programme

INSTRUMENTS D'ÉCRITURE

- Impression à 1 couleur (pour les produits métalliques, seule la gravure au laser est disponible)

STICKY NOTES

- 75 x 75 mm Adhesive Notepad (50 feuilles et papier standard)
- 101 x 75 mm Adhesive Notepad (50 feuilles et papier standard)

BRIQUETS

- Impression à 1 couleur

POSITION DE L'IMPRESSION

- 1 position standard

Quantité maximale

- Quantité indiquée en bas de la colonne de la liste de prix, sauf bloc adhésif BIC® 75 mm x 75 mm et bloc adhésif BIC® 101 mm x 75 mm, disponibles jusqu'à 5.000 unités.

Pour les commandes en ligne

- Le code promotionnel 900000480 doit être inclus dans le mot-clé. Pays admis

- Pays de l'UE, Suisse et Norvège.

Détails supplémentaires du programme

- Dans le cas où l'article commandé n'est plus disponible en stock, nous vous offrons un article alternatif d'une valeur égale ou supérieure. Dans ce cas, le délai de fabrication sera calculé à partir du moment où le client accepte l'article alternatif et approuve le nouveau design.

Conditions de la commande

- L'approbation du design doit être reçue par BIC Graphic Europe avant 12:00 GMT+1, du lundi au vendredi.

- Les fins de semaine et les jours fériés locaux d'Espagne ne sont pas considérés comme des jours ouvrables.

Expédition

- BIC Graphic Europe ne peut garantir une date spécifique de livraison, seule la date d'expédition est garantie.

Divers

- Modifications du design - Veuillez prévoir un temps supplémentaire pour les ajustements de design.
- Les comptes dont le crédit est gelé ne sont pas acceptés.
- Cette promotion n'est pas applicable aux commandes retardées par de mauvaises conditions atmosphériques, des catastrophes naturelles ou d'autres événements hors du contrôle raisonnable de BIC Graphic Europe.

DE> 48-Stunden-Druckservice

Kostenlos für über 100 BIC®-Produkte!

Angebotsanforderungen

SCHREIBGERÄTE

- Einfarbiger Aufdruck (bei Metallprodukten ist nur die Lasergravur möglich)

STICKY NOTES

- 75 x 75 mm Haftnotizen (50 Blatt und Standardpapier)
- 101 x 75 mm Haftnotizen (50 Blatt und Standardpapier)

FEUERZEUGE

- Einfarbiger Aufdruck

AUFDRUCKPOSITION

- Eine Standardposition

Größtmögliche Menge

- Menge der letzten Spalte der Preisliste, mit Ausnahme von BIC® 75 mm x 75 mm Haftnotizen und BIC® 101 mm x 75 mm Haftnotizen, erhältlich bis zu 5.000 Stück.

Für Online-Bestellungen

- Der Werbecode 90000480 muss als Schlüsselbegriff mit angegeben werden. Teilnahmeberechtigte Länder

- Länder der EU, die Schweiz und Norwegen.

Zusätzliche Angebotsdetails

- Falls wir den Artikel Ihrer Bestellung nicht auf Lager haben, werden wir Ihnen einen alternativen Artikel mit dem gleichen oder einem höheren Wert anbieten. In diesem Fall wird die Produktionszeit von dem Moment an gezählt, ab dem der Kunde den alternativen Artikel und die neue Vorlagefreigabe akzeptiert hat. Bestellanforderungen

- Die Freigabe der Vorlage muss bei BIC Graphic Europe um 12:00 P.M. GMT+1, von Montag bis Freitag eingehen.

- Wochenenden und lokale spanische Feiertage werden nicht als Werktage anerkannt.

Versand

- BIC Graphic Europe kann kein spezifisches Lieferdatum garantieren, sondern nur das voraussichtliche Versanddatum bekanntgeben.

Sonstiges

- Änderungen der Vorlage - Bitte geben Sie uns etwas zusätzliche Zeit für Anpassungen an der Vorlage.

- Kreditkonten sind nicht zulässig.

- Diese Aktion gilt nicht für Bestellungen mit Verzögerungen aufgrund von schwierigen Wittersituationen, Naturkatastrophen oder jedweder anderer Umstände, die sich außerhalb des Einflussbereiches von BIC Graphic Europe bewegen.

ES> Servicio de impresión en 48 horas

¡Gratis en más de 100 productos BIC®!

Requisitos del programa

INSTRUMENTOS DE ESCRITURA

- Impresión a 1 color (para productos metálicos sólo impresión láser)

STICKY NOTES

- 75 x 75 mm Adhesive Notepad (50 hojas y papel estándar)
- 101 x 75 mm Adhesive Notepad (50 hojas y papel estándar)

ENCENDEDORES

- Impresión a 1 color

POSICIÓN A IMPRIMIR

- 1 posición estándar

Cantidad máxima

- Precio de última columna, excepto BIC® 75 mm x 75 mm y BIC® 101mm x 75 mm Adhesive Notepad, disponibles hasta 5.000 unidades. Para pedidos online:

- El código promocional 90000480 debe incluirse en la palabra clave.

Países de aplicación

- UE, Suiza y Noruega.

Detalles adicionales del programa

- En caso de no tener stock de los artículos solicitados, le ofreceremos un artículo alternativo de igual o superior valor. En este caso, el tiempo de espera de producción se contará desde el momento en que el cliente acepte el producto alternativo y la nueva aprobación del diseño.

Requisitos del pedido

- Las aprobaciones de diseños deben ser recibidas por BIC Graphic Europe antes de las 12:00 p.m. GMT+1, de lunes a viernes.

- Fines de semana y festivos locales en España no se consideran días hábiles.

Envío

- BIC Graphic Europe no puede garantizar una fecha de entrega específica, únicamente se puede garantizar nuestra fecha del envío.

Otros

- Cambios en diseños - Las correcciones de sus diseños supondrán tiempo adicional.

- No aplicable en clientes con cuentas pendientes de pago.

- Promoción no aplicable en caso de fuerza mayor o cualquier otra situación fuera del control de BIC Graphic Europe.

IT> Servizio di stampa 48 ore

Gratis su più di 100 prodotti BIC®!

Condizioni del programma

STRUMENTI DI SCRITTURA

- Stampa a 1 colore (per i prodotti in metallo disponibile solo incisione laser)

STICKY NOTES

- 75 x 75 mm Adhesive Notepad (50 fogli e carta standard)
- 101 x 75 mm Adhesive Notepad (50 fogli e carta standard)

ACCENDINI

- Stampa a 1 colore

POSIZIONE DI STAMPA

- 1 posizione standard

Quantitativo massimo

- Quantitativo ultima colonna del listino prezzi, tranne che per blocco note adesivo BIC® 75 mm x 75 mm e blocco note adesivo BIC® 101 mm x 75 mm, disponibili fino a 5.000 unità.

Per ordini online

- Il codice promozionale 90000480 deve essere incluso nella parola chiave. Paesi che possono accedere all'offerta

- Paesi UE, Svizzera e Norvegia.

Ulteriori dettagli

- In caso di esaurimento dell'articolo ordinato, ti offriamo un articolo. Alternativo di valore equivalente o superiore. In questo caso il tempo di produzione sarà calcolato dal momento in cui il cliente ha accettato l'articolo alternativo e approvato la nuova grafica.

Requisiti dell'ordine

- L'approvazione della grafica deve essere ricevuta da BIC Graphic Europe entro le ore 12:00 p.m. GMT+1, da lunedì a venerdì.

- Fine settimana e festività locali spagnole non sono considerati giorni lavorativi.

Spedizione

- BIC Graphic Europe non può garantire una data specifica di consegna, solo la data di spedizione.

Altro

- Modifiche della grafica - si prega di concedere tempi più lunghi per gli adeguamenti della grafica.

- Non applicabile a clienti con sospensione del credito.

- Questa promozione non si applica a ordini ritardati da condizioni meteorologiche avverse, disastri naturali o altri eventi al di fuori del

ragionevole controllo di BIC Graphic Europe.



48-hour printing service

FREE ON MORE THAN 100 BIC® PRODUCTS!

PROGRAMME REQUIREMENTS



WRITING INSTRUMENTS

- 1-colour imprint (For metal products only Laser engraving available)



STICKY NOTES

- 75 x 75 mm Adhesive Notepad (50 sheets and standard paper)
- 101 x 75 mm Adhesive Notepad (50 sheets and standard paper)



LIGHTERS

- 1-colour imprint



IMPRINT POSITION

- 1 standard position



GENERAL INFORMATION

Maximum Quantity

- Price End Column Quantity, except BIC® 75 mm x 75 mm Adhesive Notepad and BIC® 101 mm x 75 mm Adhesive Notepad, available up to 5000 units

For online orders

- The promotional code 90000480 must be included in the key word.

Eligible Countries

- EU countries, Switzerland and Norway.

Additional Programme Details

- In the event that we are out of stock of the item ordered, an alternative item of equal or greater value will be offered. In this case the production lead time will be counted from when the customer has accepted the alternative item and also the new artwork approval.

Order Requirements

- Artwork approval must be received by BIC Graphic Europe by 12:00 p.m. GMT+1, Monday to Friday.
- Weekends and local Spanish holidays are not considered as working days.

Shipping

- BIC Graphic Europe cannot guarantee a specific delivery date; only shipping dates are guaranteed.

Other

- Artwork Changes - Please allow additional time for artwork adjustments.
- Accounts on credit hold are not eligible.
- This promotion does not apply to orders delayed by forces or major events beyond BIC Graphic Europe's control.



FR> Informations BIC® Sticky Notes

En raison de la nature du papier BIC® Sticky Notes, les résultats à l'impression auront un aspect mat, et non brillant. Les couleurs de référence choisies doivent être sélectionnées dans le guide d'une couleur spécifique. Les BIC® Sticky Notes sont imprimés en quadrichromie (CMYK), une technique qui ajuste la couleur d'impression afin de correspondre aux références d'une couleur spécifique.

Pour toute demande d'une couleur spécifique, nous pouvons proposer une impression avec une 5e couleur de ce Guide, à un prix majoré. Pour plus d'informations sur la manière d'obtenir la couleur correspondante la plus proche pour des impressions sur différents produits de notre catalogue, veuillez contacter notre service client.

ZONE D'IMPRESSION

Même si la partie supérieure du bloc de papier peut être imprimée (la partie adhésive), elle peut seulement être imprimée jusqu'à 60 % d'encre totale.

Indépendamment de la zone adhésive, nous recommandons d'imprimer uniquement 30 % de la surface du produit afin de laisser de l'espace pour la prise de notes et d'éviter ainsi d'éventuelles problèmes d'adhésion de l'encre sur le papier.

FORMES SPÉCIALES D'ESTAMPAGE ET AUTRES PERSONNALISATIONS

Soyez le plus original ! Demandez vos blocs adhésifs BIC® Sticky Notes avec votre forme personnalisée ou adaptez-les en incluant votre propre logo sur le verso des blocs. Veuillez vérifier les conditions de ces formules spéciales avec votre contact habituel.

IMPRESSION SHADOW OU FANTÔME

Les impressions Shadow ou fantôme sont disponibles sans surcoût. Les photographies, les dessins ou logos de grande taille qui couvrent la majorité de la surface centrale ont un meilleur rendu. Comme ces impressions sont très claires, les textes et numéros de téléphone ne sont pas recommandés en Shadow ou fantôme. Les meilleurs rendus sont obtenus à partir d'images tramées aux environs de 10 %.

DE> Information BIC® Sticky Notes

Aufgrund der Papier- Beschaffenheit der BIC® Sticky Notes, fällt das Druckergebnis matt aus. Die gewünschten Farbreferenzen wählen Sie aus der PMS Farbpalette aus. BIC® Sticky Notes werden im Offset-Druck nach Euroskala (CMYK) bedruckt. Dank dieser Technik wird das Farbergebnis an die gewünschten Pantone-Referenzen angenähert. Wenn Sie ausdrücklich eine Pantone-Farbe wünschen, können Sie zusätzlich eine fünfte Farbe aus unserem verfügbaren Repertoire auswählen.

Hierfür wird ein Aufpreis berechnet. Weitere Informationen zur Farbangleichung bei Bestellung verschiedener Produkte erhalten Sie von Ihrem Customer Service.

DRUCKBEREICH

Obwohl es möglich ist auf dem oberen, dem Haftbereich des BIC® Sticky Notes zu drucken kann nur bis zu maximal 60% der Druckfarbe aufgebracht werden. Außerhalb des Haftbereichs sollte maximal 30% der Fläche bedruckt werden, um möglichst viel Platz für Notizen frei zu lassen und das Risiko unvollständiger Aufnahme der Schreibfarbe zu vermeiden.

SPEZIELL GESTANZTE FORMEN UND ANDERE KUNDENSPEZIFISCHE ANPASSUNGEN

Seien Sie der Originellste! Bestellen Sie Ihre BIC® Sticky Notes Haftnotizen in der von Ihnen gewünschten Form oder individualisieren Sie die Rückseite der Pads mit Ihrem eigenen Logo. Bitte sprechen Sie über die Möglichkeiten für diese speziellen kundenspezifischen Anpassungen mit Ihrem zuständigen Ansprechpartner.

SHADOW-DRUCK

Flood- und Shadowdruckeffekte sind ohne Aufpreis erhältlich. Fotos, Zeichnungen oder große Logos, die einen Großteil der Grundfläche bedecken, eignen sich dafür am besten. Texte und Telefonnummern sind für Hintergrunddrucke nicht geeignet, da sie zu schwierig zu erkennen sind. Beste Resultate werden mit 10% Rasterung erzielt.

ES> Información BIC® Sticky Notes

Debido a la naturaleza del papel para BIC® Sticky Notes el resultado impreso será mate, nunca brillo. Los colores de referencia solicitados deben ser de la guía de colores exactos. El proceso de impresión para BIC® Sticky Notes es en cuatricromía (CMYK), y el resultado impreso puede variar de la referencia pantone solicitada.

En el caso de querer un color directo, podemos ofrecer la impresión con un 5º color de dicha Guía. Para una mejor aproximación de color entre los diferentes productos de nuestro catálogo, póngate en contacto con nuestro departamento de Atención al Cliente.

ÁREA DE IMPRESIÓN

A pesar de que la parte superior del taco de papel se puede imprimir (la parte adhesiva), sólo se puede imprimir hasta un 60% de tinta total.

Además de la zona adhesiva, recomendamos imprimir únicamente el 30% de la zona correspondiente al taco de papel, con el fin de dejar más espacio libre para tomar notas y evitar una absorción incorrecta de la tinta.

FORMAS ESPECIALES Y OTRAS PERSONALIZACIONES

¡Sé el más original! Solicita tus BIC® Sticky Notes con la forma deseada o personaliza con tu propio logo la hoja trasera de los blocs adhesivos. Por favor, consulta las condiciones de estas personalizaciones especiales con tu persona de contacto habitual

IMPRESIÓN "MARCA DE AGUA"

Podemos ofrecerte "marcas de agua" sin coste adicional alguno. Las fotografías, los dibujos lineales o los logotipos de gran tamaño que cubren la mayor parte del espacio central son las opciones que ofrecen mejores resultados. Puesto que la impresión de "marcas de agua" es muy clara, no se recomienda para números de teléfono o texto. Las mejores "marcas de agua" son aquellas que se imprimen en torno al 10% de intensidad.

IT> Informazioni BIC® Sticky Notes

Data la natura della carta usata per BIC® Sticky Notes il risultato di stampa sarà opaco, mai brillante. I colori scelti per la stampa devono essere colori di riferimento esatti. Il processo di stampa di BIC® Sticky Notes è la quadricromia (CMYK) ed il risultato può variare rispetto al colore di riferimento richiesto.

Se si desidera un colore preciso, potrebbe essere scelto un quinto colore dalla suddetta guida a un costo aggiuntivo.

Per maggiori informazioni sulla migliore corrispondenza del colore di stampa per i vari prodotti del nostro catalogo, contattare il nostro Servizio Clienti.

AREA DI STAMPA

Anche se la parte superiore del blocchetto si può stampare (la parte adesiva) si raccomanda di non usare quest'area per una stampa a tutto colore.

A parte la zona adesiva, si raccomanda di stampare unicamente il 30% della superficie del prodotto, per lasciare più spazio libero per prendere appunti ed evitare un assorbimento irregolare dell'inchiostro.

FORME SPECIALI FUSTELLATE E ALTRE PERSONALIZZAZIONI

Sii il più originale! Richiedi il tuo blocco note adesivo BIC® Sticky Notes con la forma realizzata su misura per te, oppure personalizza con il tuo logo il lato posteriore del blocco note. Ti invitiamo a verificare le condizioni di queste speciali personalizzazioni con il tuo referente abituale.

EFFETTO FANTASMA

Possiamo stampare effetti fantasma o sfumature senza costi aggiuntivi. Le fotografie, i disegni lineari o i logotipi di grandi dimensioni che coprono la maggior parte dello spazio centrale sono le opzioni che danno i migliori risultati. Dal momento che le stampe ad effetto fantasma sono molto chiare, non sono consigliabili per numeri di telefono o testo.

Gli effetti fantasma migliori sono quelli che si stampano a circa il 10%.

STICKY NOTES General information

Due to the nature of BIC® Sticky Notes paper, resulting imprints will appear as matte, without shine. The reference colours chosen must be selected from the exact colour guide. **BIC® Sticky Notes are printed using a 4-colour process (CMYK), a technique which adjusts the imprint colour to match the references in the exact colour guide.** As such, the resulting imprint may differ slightly from the selected exact colour guide.

If a direct exact colour is desired a fifth colour may be chosen from the aforementioned Guide for an additional charge. For more information on achieving the closest colour match for imprints on different products within our catalogue please contact our Customer Service Department.



IMPRINTING AREA

Despite the fact that it's possible to print on the upper part of the pad (the adhesive area) we can only print up to 60% colour in this area.

Apart from the adhesive area, we recommend only printing 30% of the print area of the product to leave space for note taking and avoid poor ink absorption.

DIE CUT SPECIAL SHAPES AND OTHER CUSTOMISATIONS

Be the most original! Request your BIC® Sticky Notes Adhesive pad with your desired custom-made shape or customise with your own logo the backsheet of the pads. Please check the conditions of these special customisations with your usual contact person.

SHADOW

Shadows or phantom imprints are available at no extra charge. Photographs, line drawings and large logos that cover most of the space at the centre look best. As they are very light, text and phone numbers are not recommended as phantoms. The most appealing shades are about 10%.



FR> Informations générales

- Options spéciales
- **Puffy glitter:** texture avec paillettes colorées
 - **Puffy printing:** Une personnalisation soulignée par notre encre « Puffy », pour donner un effet de relief à votre logo
 - **4-Colour process:** Permet la reproduction d'images de haute résolution. Idéal pour la reproduction de photographies. Original et attrayant
 - **Encre métallique:** Modernisez votre message en ajoutant des encres métalliques d'impression, sans frais. Disponible en bleu, vert et rose.
 - **BR:** Finition brillante.
 - **Glou in the dark:** faites étinceller votre marque même dans le noir.
 - **Finition métallique:** "Crée des effets métalliques sur les images ou l'arrière-plan."
 - **Finition holographique:** Transformez votre logo en 3D.
 - **Matte:** Finition mate.
 - **UV:** Finition extra brillante.
 - **Sandy:** effet papier de verre, avec une texture granuleuse
 - **Digital:** Quadrichromie haute définition. à 360° degrés et sur toute la longueur du corps du crayon.
 - **britePix™:** Votre message peut maintenant être imprimé en quadrichromie et d'une excellente qualité image afin de produire une impression durable et persistante de votre logo.
 - **britePix™ texture:** britePix™ Texture apporte une nouvelle touche haut de gamme au concept britePix™. Désormais, vous pouvez non seulement voir tout en couleur, mais aussi le toucher !
 - **britePix™ personalisation:** Personnalisation britePix™ Personalise chaque unité dans une seule et même commande.

- Abbreviations
- SP = Serigrafia
 - LE = Gravure laser
 - 4CP = Procédé de quadrichromie
 - HS = Estampage
 - PD = Embossage
 - DB = Lamographie
 - DT = Transfert digital
 - DG = Digital
 - BP = britePix™
 - BP Texture = britePix™ Texture
 - OT = Transfert offset
 - MOQ = Offset transfer minimale de commande

- Ink colours
- | | |
|--------------------|--------------------|
| Encre noire | Encre verte claire |
| Encre bleue claire | Encre verte foncée |
| Encre bleue foncée | Encre rose |
| Encre rouge | Encre violette |
| | Encre fluo |

- Modes d' Ecriture
- Bille
 - Stylo Plume /
 - Surligneur
 - Marqueur
 - Porte-mine
 - Crayon
 - Stylo à bille roulante
 - Gel
 - Feutre pointe fine
 - Tipp-Ex®

• **BIC® Easy-Glide system option** Offre une encre qui est 35% plus lisse et plus épaisse que votre

- stylo à bille actuel.
- Autres symboles
- **Mix&Match:** Des centaines de couleurs de composants en stock pour la personnalisation complète des instruments d'écriture
 - **PMS Service:** Choisissez la couleur PMS pour des décorations les mieux adaptées à votre logo
 - **QR CODE:** scannez le QR code et visionnez la vidéo
 - **48 hour:** Service 48 h disponible
 - **Mobius loop:** Le produit contient des matériaux recyclés. Si vous voulez plus d'informations sur notre BIC® Ecolutions™ et son mode de fabrication https://www.bicworld.com/fr/nos-engagements/en-bref
 - **Renewable Resource:** Produit fabriqué avec des matériaux respectant l'environnement, utilisant des matériaux renouvelables de conifères (polymères cellulosiques).
 - **Pays d'origine**
 - **APP:** Téléchargez l'application de BIC® Graphic et scannez les pages où figure cette icône.
 - **Nouveautés / Nouveaux colori.**
 - **EN 13869:** Règlement de sécurité des enfants pour les briquets.
 - **ISO 22702:** Cette norme certifie la qualité de tous les briquets à usages multiples.
 - **ISO 9994:** Normes de sécurité internationales pour les briquets.
 - **Sticky Notes:** Nombre de pages
 - **Notebooks:** Nombre de pages
 - **Informations sur l'emballage**
 - **BIC® Boy:** Iconic BIC® Boy est embossé
 - **Sande:** lubrifiant
 - **Nombre de lames**
 - **BIC® Mega Lighter:** usage quotidien du BIC® Mega Lighter
 - **Nombre d'allumages**
 - **Tube de gel à rasage:** 10 ml uniquement disponible pour l'Autriche, la Belgique, la France, l'Allemagne, l'Italie, le Luxembourg, les Pays-Bas, le Portugal, la Roumanie, l'Espagne, la Suisse et le Royaume-Uni.
 - **Exclusive Articles exclusifs disponibles** seulement dans notre catalogue.
 - **Bluetooth®**
 - **Fréquence**
 - **Impédance**
 - **Sensibilité**
 - **Diamètre aimant**
 - **Sans câbles**
 - **Autonomie de la batterie**
 - **Longueur du cordon**
 - **Résistant à l'eau**
 - **Ruissance**
 - **Antichoc**
 - **Point par pouces**
 - **Entrée/sortie alimentation**
 - **Résolution du video**
 - **Résolution du video**
 - **Objectif du camera**
 - **Dimension du écran**

Dimensions
Les dimensions publiées de tous les produits correspondent à la taille maximale, quelle que soit la position du dessin.

- Andere Symbole
- **Mix&Match:** Hunderte von Farben bei den Schreibgeräte-Komponenten auf Lager. Für eine komplette Personalisierung
 - **PMS Service:** Wählen Sie die PMS-Farbe für Verzierungen, die am besten zu Ihrem Logo passen
 - **QR CODE:** Scannen Sie den QR Code und sehen Sie sich das Video an
 - **48 Stunden Service**
 - **Möbius Schleife:** Das Produkt enthält recyceltes Material. Mehr Informationen unter: bicgraphic.eu/ie/sustainable-development.html
 - **Renewable Resource:** Das Produkt ist zu aus umweltfreundlichem Material hergestellt, indem metallisch erneuerbare Weichholz-Materialien verwendet wurden (Polymere auf Cellulose-Basis).
 - **Herkunftsland**
 - **APP:** Laden Sie sich die BIC Graphic App herunter und scannen Sie die mit diesem Symbol gekennzeichneten Artikel.
 - **Neue / Neue Farben**
 - **EN 13869 Europäische Kindersicherheitsnorm für Feuerzeuge**
 - **ISO 22702 Dieser Standard zertifiziert die Qualität**
 - **ISO 9994 Internationale Sicherheitsstandards für Feuerzeuge**
 - **Sticky Notes Anzahl der Blätter.**
 - **Notebooks Anzahl der Blätter.**
 - **Information zu Verpackungen**
 - **BIC® Boy:** Der ikonische BIC®-Boy ist hier aufgeführt
 - **Gleistreifen**
 - **Anzahl der Klängen**
 - **BIC® Mega Lighter:** Verwendung des BIC® Mega Lighters in Alltagssituationen.
 - **Anzahl der Klängen**
 - **Rasiergelbube 10 ml** nur erhältlich in Österreich, Belgien, Frankreich, Deutschland, Italien, Luxemburg, Niederlande, Portugal, Rumänien, Spanien, Schweiz und Vereinigtem Königreich.
 - **Exklusivartikel / Markiert Artikel,** die Sie ausschließlich aus unserem Katalog bestellen können.
 - **Bluetooth®**
 - **Fréquence**
 - **Scheinwiderstand**
 - **Empfindlichkeit**
 - **Magnetdurchmesser**
 - **kabellos**
 - **Akkulaufzeit**
 - **Kabellänge**
 - **Wasserabweisend**
 - **Leistung**
 - **Stoßfest**
 - **Punkte pro Zoll**
 - **Eingangs- / Ausgangsleistung**
 - **Videoauflösung**
 - **Kameraobjektiv**
 - **Bildschirmgröße**
- Abmessungen
Die Abmessungen, die für jedes Produkt angegeben werden, entsprechen der maximalen Größe, in Unabhängigkeit von der Zeichnungsposition.

ES> Símbolos y abreviaturas

- Técnicas de impresión
- **Puffy glitter:** Textura de color brillante
 - **Impresión Puffy:** Resalta tu personalización dándole efecto relieve a tu logo.
 - **4-colour process:** Permite la reproducción de imágenes de alta resolución. Ideal para la reproducción de fotografías. Original y atractivo.
 - **Tinta metálica:** Tinta metálica sin ningún coste adicional. Disponible en colores azul, verde y rosa.
 - **BR:** Acabado brillante
 - **Glou in the dark:** Haz que tu marca brille incluso en la oscuridad.
 - **Acabado metálico:** Crea efectos metálicos en imágenes o fondos.
 - **Acabado holográfico:** Convierte tu logo en una imagen tridimensional usando hologramas.
 - **Maté:** Acabado mate.
 - **UV:** Acabado super brillante.
 - **Sandy:** Textura granulada con efecto arena
 - **Digital:** Cuatricromía de alta definición. 360° en el cuerpo entero.
 - **britePix™:** Impresión a todo color con resultados fotográficos de alta calidad que asegura una impresión duradera de su logo.
 - **britePix™ Texture:** britePix™ Texture es un añadido premium al concepto britePix™ - ahora no sólo puedes verlo sino que también puedes sentirlo!
 - **britePix™ personalisation:** Personalización britePix™ Personaliza cada unidad en el mismo pedido britePix™.

- Abreviaturas
- SP = Serigrafía
 - LE = Impresión a láser
 - 4CP = Proceso de cuatricromía
 - HS = Hot stamping
 - DB = Grabado en relieve
 - PD = Tampografía
 - DT = Transferencia digital
 - DG = Digital
 - BP = britePix™
 - BP Texture = britePix™ Texture
 - OT = Transferencia offset
 - MOQ = Cantidad mínima de pedido

- Colores de tinta
- | | |
|-------------------|--------------------|
| Tinta negra | Tinta verde claro |
| Tinta azul claro | Tinta verde oscuro |
| Tinta azul oscuro | Tinta rosa |
| Tinta roja | Tinta morada |
| | Tinta fluo |

- Modos de escritura
- Bolígrafo
 - Plumón
 - Resaltador
 - Marcador
 - Portaminas
 - Lápiz
 - Roller
 - Gel
 - Escritura fina
 - Tipp-Ex®

• **BIC® Easy-Glide system option:** 35% más fluido y más intenso que nuestro bolígrafo actual.

IT> Simboli e abbreviazioni

- Opzioni speciali
- **Puffy glitter:** texture with glitter colorati
 - **Puffy printing:** Una personalizzazione evidenziata con il nostro inchiostro "Puffy" per un effetto a rilievo al tuo logo.
 - **4-colour process:** Consente la riproduzione di immagini ad alta risoluzione. Ideale per la riproduzione di fotografie. Originale e attraente.
 - **Inchiostro metallizzato:** Stampa metallizzati senza costi aggiuntivi. Disponibile nei colori blu, verde e rosa.
 - **BR:** finitura brillante
 - **Glou in the dark:** rendi il tuo marchio visibile anche al buio
 - **Acabado metálico:** Crea effetti, immagini o sfondi metallici. Il tuo marchio sarà inconfondibile.
 - **Finitura olografica:** Trasforma il tuo logo in un'immagine tridimensionale con gli ologrammi. Rende il tuo messaggio straordinario.
 - **Matte:** finitura opaca
 - **UV:** finitura lucida
 - **Sandy:** effetto sabbia con texture granulata
 - **Digital:** Alta definizione - stampa in digitale in quadrichromia. 360° gradi su tutta la lunghezza del corpo.
 - **britePix™:** Il messaggio può essere stampato a colori con l'eccellente risoluzione fotografica che assicura un'impressione durevole e vibrante del vostro logo
 - **britePix™ Texture:** britePix™ Texture è un salto di qualità nel nostro concetto di stampa britePix™ - ora non solo puoi vedere il colore pieno, ma puoi anche toccarlo!
 - **britePix™ personalisation:** Personalizzazione britePix™ Personalizza ogni unità dello stesso ordine britePix™
- Abbreviazioni
- SP = Serigrafia
 - LE = Incisione laser
 - 4CP = Stampa in quadrichromia
 - HS = Stampa a caldo
 - DB = Bassorilievo
 - PD = Stampa a tampone
 - DT = Trasferimento digitale
 - DG = Digitale
 - BP = britePix™
 - BP Texture = britePix™ Texture
 - OT = transfer in offset
 - MOQ = Quantità minima d'ordine
- Colori d'inchiostro:
- | | |
|---------|--------------|
| nero | verde chiaro |
| azzurro | verde |
| blu | rosa |
| rosso | viola |
| | flujo |
- Modalità di scrittura
- Penna a sfera
 - Penna Stilografica
 - Evidenziatore
 - Pennarello
 - Portamine
 - Matita
 - Roller
 - Gel
 - Finestyle
 - Tipp-Ex®
- **BIC® Easy-Glide system option** Offre il 35% di scrittura più fluida e corposa rispetto agli inchiostri standard.

- Otros símbolos
- **Mix&Match:** Cientos de componentes de instrumentos de escritura para una completa personalización.
 - **PMS Service:** Elija para los atributos, el colour PMS que mejor se adapte a su logo
 - **Código QR:** Escanea el código QR y mira el video
 - **48 hour:** Servicio 48 h disponible
 - **Mobius loop:** El producto contiene material reciclado. Para más información sobre nuestros productos BIC Ecolutions™ y cómo están hechos visita: https://www.bicworld.com/fr/nos-engagements/en-bref
 - **Renewable Resource:** Producto elaborado de material ecológico fabricado con materiales de coníferas naturales renovables (polímeros celulósicos).
 - **Pais de origen**
 - **APP:** Descarga la aplicación de BIC® Graphic y escanea las páginas que tengan este icono.
 - **Nuevo / Nuevos colores**
 - **EN 13869:** Regulaciones Europeas para Encendedores con seguridad para niños
 - **ISO 22702:** This standard certifies the quality of all utility lighters.
 - **ISO 9994:** Normas internacionales de seguridad para encendedores.
 - **Sticky Notes:** Número de hojas.
 - **Notebooks:** Número de hojas.
 - **Información de envasado**
 - **BIC® Boy:** El icónico BIC® Boy con relieve aquí
 - **Banda lubricante**
 - **Número de hojas**
 - **BIC® Mega Lighter:** Usa el BIC® Mega Lighter diariamente.
 - **Número de encendidos**
 - **Gel de afeitado de 10ml** sólo disponible para Austria, Bélgica, Francia, Alemania, Italia, Luxemburgo, Países Bajos, Portugal, Rumania, España, Suiza y Reino Unido.
 - **Exclusivo Productos exclusivos** sólo disponibles a través de nuestro catálogo.
 - **Bluetooth®**
 - **Frecuencia**
 - **Impedancia**
 - **Sensibilidad**
 - **Diametro del imán**
 - **Sim cables**
 - **Autonomía de la batería**
 - **Longitud cable**
 - **Resistente al agua**
 - **Potencia**
 - **A prueba de golpes**
 - **Puntos por pulgada**
 - **Entrada/salida corriente eléctrica**
 - **Resolución video**
 - **Resolución cámara**
 - **Objetivo cámara**
 - **Dimension pantalla**

Dimensiones
Las dimensiones publicadas en cada producto corresponden a su tamaño máximo, independientemente de la posición que muestre el dibujo.

- Altri simboli
- **Mix&Match:** Centinaia di colori dei componenti di produzione degli strumenti di scrittura per una personalizzazione completa
 - **PMS Service:** Scegli il colore PMS per le finiture che meglio si adatta al tuo logo
 - **QR CODE:** scannizza il QR code e guarda il video
 - **48 hsc:** Servizio in 48 ore disponibile
 - **Mobius loop:** Per maggiori informazioni sui nostri prodotti BIC Ecolutions™ e da cosa sono composti visita la web: https://www.bicworld.com/fr/nos-engagements/en-bref
 - **Renewable Resource:** Prodotto composto da materiali ecologici, realizzato con materiali naturali di conifere rinnovabili (polimeri cellulósicos).
 - **APP:** Scarica la app di Bic Graphic e scannizza le pagine che abbiano questo icono.
 - **Paise d'origine**
 - **Nuovi / Nuovi colori**
 - **Morbido al tatto!** Toccare questo prodotto sarà una sorpresa.
 - **EN 13869:** Normativa europea per accendini sulla sicurezza dei bambini.
 - **ISO 22702:** Questa normativa certifica la qualità di tutti i nostri accendini.
 - **ISO 9994:** Norme di sicurezza internazionali per gli accendini.
 - **Sticky Notes:** Numero di fogli.
 - **Notebooks:** Numero di fogli.
 - **Informazioni sul packaging**
 - **BIC® Boy:** Iconico BIC Boy è impresso qui
 - **Strisca lubrificante**
 - **Numero di lame**
 - **BIC® Mega Lighter:** Utilizzo quotidiano del BIC® Mega Lighter
 - **Número de accensioni**
 - **Confezione di gel da rasatura da 10 ml,** disponibile solo per Austria, Belgio, Francia, Germania, Italia, Lussemburgo, Paesi Bassi, Portogallo, Romania, Spagna, Svizzera e Regno Unito.
 - **Esclusivo Prodotti che sono esclusivi** all'interno del nostro catalogo.
 - **Bluetooth®**
 - **Frequenza**
 - **Impedenza**
 - **Sensibilità**
 - **Diametro magnete**
 - **Senza cavo**
 - **Autonomia della batteria**
 - **lunghezza cavo**
 - **Resistente all'acqua**
 - **Potenza**
 - **A prova di urti**
 - **Punti per pollice**
 - **Entrata/uscita alimentazione**
 - **Risoluzione video**
 - **Risoluzione camera**
 - **Obiettivo camera**
 - **Dimensione schermo**
- Dimensioni
Le dimensioni pubblicate relative a ciascun prodotto corrispondono alla sua dimensione massima indipendentemente dalla posizione del disegno.

Symbols & Abbreviations

PRINTING TECHNIQUES



Puffy glitter
Coloured glitter texture.



Puffy Printing
Highlighted personalisation giving a relief effect to your logo.



4-Colour Process
Allows reproduction of high-resolution images. Ideal for reproducing photos.



BR
Brilliant finish.



Glow in the dark
Make your brand glow even in the dark.



Metallic Finish
Create metallic effects on images and backgrounds.



Holographic Finish
Convert your logo into a three-dimensional



Matt
Matt finish.



UV
High gloss finish.



Sandy
Sandpaper effect with a granulated texture.



Digital
High-definition 4-colour process. 360° degrees and full length of the barrel/body.



britePix™
Full-colour with photographic excellence, producing a durable imprint that ensures lasting impressions of your logo.



britePix™ Texture
britePix™ Texture is a fresh addition to our britePix™ concept: now you don't just see the full colour - you can feel it!



britePix™ personalisation
Personalise each unit within the same britePix™ order.

ABBREVIATIONS

SP = Screen printing
LE = Laser engraving
4CP = 4-colour process
HS = Hot stamping
DB = Debossing
PD = Pad printing
DT = Digital transfer
DG = Digital
BP = britePix™
BP Texture = britePix™ Texture
OT = Offset transfer
MOQ = Minimum order quantity

INK COLOURS

Black Ink Light Green Ink
Light Blue Ink Dark Green Ink
Dark Blue Ink Pink Ink
Red Ink Fluo Ink



BIC® Easy-Glide system option
Offers 35% smoother and bolder write-out than our standard ink.

WRITING MODES

M Medium Ballpen
F Fine
B Bold
MP Mechanical Pencil
Ø 0,7 mm
PC Pencil
R Roller Ball
MK Marker
FP Fountain Pen
FS Finestyle
HL Highlighter
T Tipp-Ex®
G Gel

OTHER SYMBOLS



Mix&Match
Hundreds of colours of components in stock of writing instruments for full personalisation.



Exact colour match
Choose the exact colour for trims that best matches your logo.



QR code
Scan QR code and watch the video.



48-Hour
48-Hour Printing Service



Möbius Loop
Product contains recycled material. If you want more information about our BIC® Ecolutions® & how it's made visit: bicgraphic.eu/ie/sustainable-development.html.



Renewable Resource
Product made with eco-friendly material manufactured using natural, renewable softwood materials (cellulosic polymers).



Country of Origin



APP
Download the BIC Graphic App and scan the pages that have this icon.

New!
New colours!

New / New colours



EN 13869
European Child Resistant Regulation for lighters.



ISO 22702
This standard certifies the quality of all utility lighters.



ISO 9994
International Safety Standards for lighters.



Sticky Notes
Number of sheets.



Notebooks
Number of sheets.



Packaging Information



BIC® Boy
Iconic BIC® Boy is embossed here



Lubricating strip



Number of blades



BIC® Mega Lighter
Usage of BIC® Mega Lighter in everyday occasion.



Number of flames



Shaving gel tube 10ml only available for Austria, Belgium, France, Germany, Italy, Luxembourg, The Netherlands, Portugal, Romania, Spain, Switzerland and UK.



Exclusive
Exclusive items only available through our catalogue.



Bluetooth®



Frequency



Impedance



Sensitivity



Magnet diameter



Wireless



Battery autonomy



Cable length



Waterproof



Power



Shockproof



Dot per inch



Power entrance/exit



Video resolution



Camera resolution



Camera objective



Screen dimension

DIMENSIONS Dimensions published of each product correspond to its maximum size, regardless of the drawing position.

FR> Informations générales**INFORMATIONS CONCERNANT LES FICHIERS**

Fichiers à fournir :

- un fichier électronique avec le dessin graphique
- et un fichier différent pour le texte.

Pour un marquage au laser individuel, les textes devront être fournis uniquement sous format Excel® (.xls).

PROPRIÉTÉS DU MATÉRIEL GRAPHIQUE

Envoyez-nous votre matériel graphique dans un des types de fichiers suivants :

- JPG / 350 dpi sans compresser à la taille réelle de marquage (seulement images, sans texte)
- PDF / vectorisé
- Illustrator® CC / vectorisé
- Photoshop® CC / avec les couches
- Fichiers ZIP

Il est important que vous nous fassiez parvenir les informations dans l'un de ces formats afin de traiter au mieux votre commande et d'obtenir un résultat final optimal.

Si la création du client ne rentre pas dans notre format, nous modifierons en conséquence.

TYPE DE CARACTÈRES:

- Tous les types de caractères doivent être convertis en image. Vérifiez les tailles minimales des types et les épaisseurs de trait.

Veillez contacter le service clientèle pour plus d'informations.

SPECIAL POUR LES PRODUITS D'ÉCRITURE

La zone d'impression disponible dépend de la technique d'impression requise.

SPECIAL POUR LES BRIQUETS (J25, J26, J38 ET J39)

Pour toute demande de couleur directe Pantone, nous pouvons proposer une impression avec une 5e couleur de ce Guide, à un prix majoré. Pour plus d'informations sur la manière d'obtenir la couleur correspondante la plus proche pour des impressions sur différents produits de notre catalogue, veuillez contacter notre service client.

Paramètres techniques pour chacun des types d'impression

SERIGRAFIE / TAMPOGRAFIE - ESTAMPAGE / EMBOSAGE

LASER-STICKY NOTES - DIGITAL / TRANSFERT DIGITAL - britePix™

Texte positif minimum

Texte négatif minimum

Épaisseur minimale des lignes positives

Épaisseur minimale des lignes négatives

Épaisseur minimale des demi-teintes

Pourcentage de demi-teinte

Valeur minimale de demi-teinte

COULEURS SPÉCIALES D'IMPRESSION NOTEBOOKS

Couleurs d'estampage à chaud

COULEURS EXACTES QUI REQUIÈRENT UNE COUCHE DE FOND BLANCHE

Plusieurs références de couleur requièrent une couche de fond blanche lorsqu'elles sont imprimées sur des surfaces foncées (noir, bleu foncé, rouge) pour pouvoir obtenir le résultat souhaité par le client.

- Si le produit permet seulement 1 impression, le représentant du service clients devra prévenir le client que le résultat de la couleur imprimée sera approximatif.

- Si le produit permet une impression supplémentaire, le représentant du service clients offrira au client la possibilité d'obtenir la couleur exacte AVEC une couche de fond blanche (moyennant majoration du prix).

DE> Allgemeine Information**DRUCKVORLAGEANFORDERUNGEN:**

Bitte senden Sie uns folgende Dateien:

- reprofähige Druckvorlagen als Grafik
- Separate Textdatei.

Für personalisierte Lasergravuren müssen die Texte im Excel®-Format (.xls) eingeschickt werden.

TECHNISCHE DATEN DER GRAFIKDATEIEN

Bitte schicken Sie Ihre Grafiken in einem dieser Formate:

- JPG / 350 dpi nicht komprimiert und in der tatsächlichen Druckgröße (nur Bilddaten, kein Text)
- PDF / Vektordatei
- Illustrator® CC / Vektordatei
- Photoshop® CC / mit Ebenen
- ZIP format

Wir bitten um Zusendung der Daten in den angegebenen Formaten. Damit können wir den Auftrag schnellstmöglich bearbeiten und ein optimales Druckergebnis erreichen. Sofern der Entwurf des Kunden nicht in unseren Druckbereich passt, werden wir ihn entsprechend anpassen.

SCHRIFTTYPEN:

- Alle Schriftarten müssen in eine Vorlage umgewandelt werden.

Überprüfen Sie die Mindestschriftgrößen und Linienstärken. Für weitere Informationen kontaktieren Sie bitte unseren Kundenservice

SPEZIELL FÜR SCHREIBPRODUKTE

Die mögliche Werbeaufdruckfläche ist von der angeforderten Drucktechnik abhängig.

SPEZIELL FÜR DIGITALE FEUERZEUGE (J25, J26, J38 UND J39)

Wenn Sie ausdrücklich eine Pantone-Farbe wünschen, können Sie zusätzlich eine fünfte Farbe aus unserem verfügbaren Repertoire auswählen. Hierfür wird ein Aufpreis berechnet. Weitere Informationen zur Farbangleichung bei Bestellung verschiedener Produkte erhalten Sie von Ihrem Kundenservice.

Technische Parameter für jeden Typendruck

SIEBDRUCK / TAMPONDRUCK - HOTSTAMPING / PRÄGUNG - LASERGRAVUR - STICKY

NOTES - DIGITAL / DIGITALDRUCK - britePix™

Minimum positiver Text

Minimum negativer Text

Mindeststärke für Linien im Positivdruck

Mindeststärke für Linien im Negativdruck

Mindeststärke für Halbtöne

Prozentsatz Halbtöne

Mindestwerte für Halbtöne

SPEZIELLE WERBEAUFDRUCKFARBEN NOTEBOOKS

Farben für Heißprägung

FARBGETREUE FARBEN, FÜR DIE EIN WEISSER UNTERGRUND ERFORDERLICH IST

Es gibt verschiedene Farbreferenzen, für die ein weißer Untergrund erforderlich ist, wenn auf dunklen Flächen gedruckt werden soll (schwarz, dunkelblau, rot), um das vom Kunden gewünschte Resultat zu erzielen:

- Falls für das Produkt nur ein Aufdruck möglich ist, wird ein Mitarbeiter des Kundendienstes dem Kunden darüber informieren, dass die aufgedruckte Farbe nur annähernd dem gewünschten Farbton entspricht.
- Ist für das Produkt ein zusätzlicher Aufdruck möglich, wird der Kundendienstmitarbeiter dem Kunden das Angebot machen, die gewünschte Farbe (gegen Aufpreis).

ES> Información general**INFORMACIÓN SOBRE ARCHIVOS**

En cualquier caso, los archivos deben ser dos:

- un archivo electrónico con el diseño gráfico (creatividad)
- y otro archivo distinto para el texto.

Para un grabado en láser, facilite los textos únicamente en formato Excel® (.xls).

PROPIEDADES DEL MATERIAL GRÁFICO

Envíenos su material gráfico en alguno de los siguientes tipos de archivo:

- JPG / 350 dpi sin comprimir al tamaño real de impresión (sólo imágenes, sin texto)
- PDF / vectorizado
- Illustrator® CC / vectorizado
- Photoshop® CC / con capas
- Archivos ZIP

Es importante que nos proporcione la información en uno de estos formatos para agilizar su pedido y para obtener un resultado final adecuado.

Si el diseño del cliente no encaja correctamente en el área de impresión, lo modificaremos consecuentemente.

FUENTES:

- Todos los tipos de letra se deben convertir en un arte final. Verifique los tamaños de los tipos mínimos y grosos de línea.

Por favor, contacte con Atención al Cliente para más información.

ESPECIAL PARA INSTRUMENTOS DE ESCRITURA

Área de impresión disponible según la técnica de impresión.

ESPECIAL PARA ENCENDEDORES EN DIGITAL (J25, J26, J38 & J39)

En el caso de querer un color directo, podemos ofrecer la impresión con un 5º color de dicha Guía. Para una mejor coincidencia de color entre los diferentes productos de nuestro catálogo, póngase en contacto con nuestro departamento de Atención al Cliente.

Parámetros técnicos para cada tipo de impresión

SERIGRAFIA / TAMPOGRAFIA - HOTSTAMPING / GRABADO EN RELIEVE - LÁSER -

STICKY NOTES - DIGITAL / TRANSFERENCIA DIGITAL - britePix™

Texto mínimo positivo

Texto mínimo negativo

Grosor mínimo para líneas positivas

Grosor mínimo para líneas negativas

Grosor mínimo de marca de agua

Porcentajes de marca de agua

Valores mínimos de marca de agua

IMPRESIÓN DE COLORES ESPECIALES NOTEBOOKS

Colores para Hot-stamping

COLORES EXÁCTOS QUE REQUIEREN UNA PASADA DE BLANCO DEBAJO

Hay varias referencias de colores que necesitan una pasada de blanco cuando son impresos sobre superficies oscuras (negro, azul oscuro, rojo) para obtener el resultado que requiere el cliente.

- En caso que el producto solo admita 1 color de marcado, el representante de atención al cliente informará al cliente de que el resultado será aproximado.

- En caso que el producto permita una pasada más, el representante de atención al cliente ofrecerá al cliente la posibilidad de obtener el color exacto imprimiendo una pasada de blanco (con extra coste).

IT> Informazioni Generali**INFORMAZIONE SUI FILE:**

- Sempre, per quanto riguarda i file, i documenti si devono inviare come di seguito:
- un file elettronico con il design grafico (creatività)

- ed un altro file separato per il testo. Per un'incisione a laser singola, consegnare i testi esclusivamente in formato Excel® (.xls).

PROPRIETÀ DEL MATERIALE GRAFICO

Inviateci il vostro materiale grafico in uno dei seguenti tipi di file:

- JPG / 350 dpi non compresso e nel formato reale della stampa (solo per le immagini, non per il testo)
- PDF / vettorializzato
- Illustrator® CC / vettorializzato
- Photoshop® CC / con livelli
- file ZIP

È importante che le informazioni vengano mandate in uno dei formati indicati al fine di sveltere l'ordine ed ottenere un miglior risultato finale. Nel caso in cui il design del cliente non si adattasse all'area di stampa, verrà adattato di conseguenza.

CARATTERI:

- Tutti i caratteri devono essere convertiti in immagine. Verificare le dimensioni minime del carattere e gli spessori del tratto.

SPECIALE PER PRODOTTI DI SCRITTURA

L'area di stampa disponibile dipende dalla tecnica desiderata.

SPECIALE PER ACCENDINI DIGITALI (J25, J26, J38 E J39)

Se si desidera un colore preciso, potrebbe essere scelto un quinto colore dalla suddetta guida a un costo aggiuntivo. Per maggiori informazioni sulla migliore corrispondenza del colore di stampa per i vari prodotti del nostro catalogo, contattate il nostro Servizio Clienti.

Parametri tecnici per ciascun tipo di stampa

SERIGRAFIA / TAMPOGRAFIA - STAMPA A CALDO / BASSORILIEVO - LASER -

STICKY NOTES - DIGITALE / TRASFERIMENTO - DIGITALE - britePix™

Testo positivo minimo

Testo negativo minimo

Spessore minimo per linee positive

Spessore minimo per linee negative

Spessore minimo per mezzi toni

Percentuale mezzo tono

Valori minimi mezzo tono

COLORI STAMPA SPECIALE NOTEBOOKS

Colori stampa a caldo

COLORI PRECISI CON NECESSITÀ DI SFONDO BIANCO

Alcuni codici di colore richiedono uno sfondo bianco in caso di stampa su superfici scure (nero, blu scuro, rosso) in modo da ottenere il risultato desiderato.

- Se il prodotto consente solo 1 stampa, il referente del servizio clienti informerà che il colore finale della stampa potrebbe essere leggermente diverso.

- Se il prodotto consente un'ulteriore stampa, il referente del servizio clienti offrirà la possibilità di ottenere il colore esatto CON uno sfondo bianco (con un supplemento di prezzo).

General information

FILE INFORMATION

Please submit your artwork in one of the following formats:

- Electronic file with the graphic design (artwork).
- Separate file for the text. For individual laser engraving please provide texts only in Excel® format (.xls)

ARTWORKS FEATURES

Please submit your artwork in one of the following formats:

- JPG / 350 dpi not compressed (only for images, no texts)
- PDF / outlined
- Illustrator® CC / outlined
- Photoshop® CC / with layers
- ZIP files

In order to facilitate a fluid order process and obtain an appropriate final result, it is important to provide us the information in one of the above listed formats. Should the customer's design not fit into our imprint area, we will modify it accordingly.

Typefaces:

- All the typefaces must be converted to an artwork. Verify the minimum type sizes & line weights. Please, contact Customer Service for further information.

SPECIAL FOR WRITING PRODUCTS

Available imprint area depends on required printing technique.

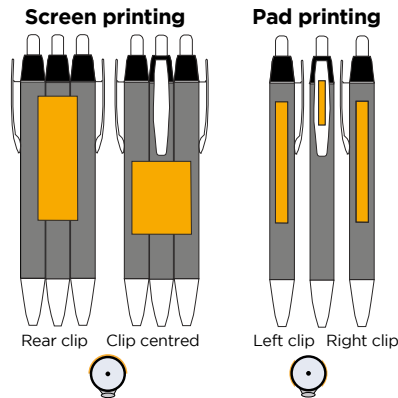

SPECIAL FOR DIGITAL LIGHTERS (J25, J23 & J26)

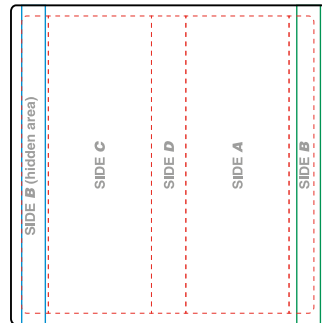

If a direct exact colour is desired a fifth colour may be chosen from the aforementioned Guide for an additional charge. For more information on achieving the closest colour match for imprints on different products within our catalogue please contact our Customer Service Department

TECHNICAL PARAMETERS FOR EACH TYPE OF PRINTING

	SCREEN PRINTING/ PAD PRINTING		HOT STAMPING / DEBOSSING		LASER ENGRAVING	
Minimum positive text	6 pt (2.1 mm)	6 Point text	10 pt (3.5 mm)	10 Point text	6 pt (2.1 mm)	6 Point text
Minimum negative text	9 pt (3.1 mm)	9 Point text	15 pt (5.25 mm)	15 Point	NOT RECOMMENDED	
Minimum thickness for positive lines	0.4 pt (0.14 mm)	—————	1.5 pt (0.5 mm)	—————	0.3 pt (0.1 mm)	—————
Minimum thickness for negative lines	0,5 pt (0.176 mm)	██████████	2 pt (0.706 mm)	██████████	0.5 pt (0.17 mm)	██████████
Minimum thickness for half tones	1.5 pt (0.5 mm)	—————	NOT POSSIBLE	—————	NOT POSSIBLE	—————
Percentage half tone	50%	—————	—————	—————	—————	—————

STICKY Notes

	STICKY Notes		DIGITAL / DIGITAL TRANSFER	
Minimum positive text	4 pt (1.4 mm)	4 Point text	4 pt (1.4 mm)	4 Point text
Minimum negative text	5 pt (1.75 mm)	5 Point text	7 pt (2.4 mm)	7 Point text
Minimum text for half tone	7 pt (2.4 mm)	7 Point text	1.5 pt (0.5 mm)	7 Point text
Minimum thickness for positive lines	0.3 pt (0.1 mm)	—————	0.25 pt (0.08 mm)	—————
Minimum thickness for negative lines	0.5 pt (0.17 mm)	██████████	0.5 pt (0.17 mm)	██████████
Minimum thickness for lines in half tone	0.5 pt (0.17 mm)	—————	0.5 pt (0.17 mm)	—————
Minimum half tone values	C: 5% / M: 5% / Y: 15% / K: 5% ○ ○ ○ ○		C: 8% / M: 8% / Y: 12% / K: 8% ○ ○ ○ ○	

britePix™

Minimum positive text	6 pt (2.1 mm)	6 Point text
Minimum negative text	7 pt (2.4 mm)	7 Point text
Minimum thickness for positive lines	0.4 pt (0.14 mm)	—————
Minimum thickness for negative lines	0.5 pt (0.17 mm)	██████████
Minimum thickness for half tones	1 pt (0.35 mm)	—————
Percentage half tone	—————	—————

SPECIAL IMPRINT COLOURS

NOTEBOOKS

Hot-stamping colours Silver Gold Holographic Black Red Blue White Green

EXACT COLOURS WITH WHITE UNDERLAYER REQUIREMENT

There are some colour references that need a white underlayer when we print on dark surfaces (Black, Dark blue, Red) in order to get the result required by the customer.

- In case the product only allows 1 imprint, the Customer Service representative will inform the customer that the final imprinted colour will be approximate.
- In case the product allows an additional imprint, the Customer Service representative will offer the customer the possibility to obtain the exact colour WITH a white underlayer (at extra cost).

Product Index

GENERAL INFORMATION

	PAGE
BIC® WRITING INSTRUMENTS	
Basic pen.....	194
BIC® 4 Colours.....	110
BIC® 4 Colours 3+1HB.....	121
BIC® 4 Colours Fashion.....	114
BIC® 4 Colours Fine.....	118
BIC® 4 Colours Fluo.....	119
BIC® 4 Colours Mini.....	112
BIC® 4 Colours Shine.....	116
BIC® 4 Colours Stylus.....	120
BIC® 4 Colours Sun.....	113
BIC® Atlantis®.....	100
BIC® Atlantis® Gel.....	134
BIC® Attriant®.....	124
<small>New colour!</small> BIC® Brite Liner® Grip.....	150
BIC® Clic Ecolutions®.....	104
BIC® Clic Gold Ecolutions®.....	107
BIC® Clic Stic.....	70
BIC® Clic Stic Ecolutions®.....	72
BIC® Clic Stic Mini Digital.....	75
BIC® Clic Stic Softfeel®.....	74
BIC® Clic Stic Stylus.....	74
BIC® Evolution® Ecolutions®.....	166
BIC® Evolution® Ecolutions® Colouring set... ..	187
BIC® Evolution® Ecolutions® set of 6 colouring pencils.....	179
<small>New!</small> BIC® Gel-Ocity® Illusion.....	130
BIC® Grip Roller.....	136
BIC® Grip Roller Gold.....	139
BIC® Intensity® Gel Clic.....	140
BIC® MIO® Clic.....	54
<small>New colour!</small> BIC® Mark-it Permanent Marker.....	158
BIC® Matic®.....	160
<small>New colour!</small> BIC® Matic® Ecolutions®.....	163
BIC® Matic® Grip.....	164
BIC® Matic® Quartz.....	164
BIC® Media Clic.....	58
BIC® Media Clic.....	58
BIC® Media Clic Ecolutions®.....	63
BIC® Media Clic Ecolutions®.....	63
BIC® Media Clic Grip.....	64
BIC® Media Clic Grip®.....	64
BIC® Media Clic Grip Ecolutions®.....	65
BIC® Media Clic Premium.....	69
BIC® Permanent Marker Ecolutions®.....	159
BIC® Plastidecor® Colouring Set.....	185
BIC® Plastidecor® set of 6 crayons.....	177
BIC® Protrusion Grip.....	125
BIC® Roller Glide® PRO.....	144
BIC® Round Stic®.....	48
BIC® Round Stic® Ecolutions®.....	51
BIC® Style.....	44
BIC® Style Clear.....	46
BIC® Super Clip.....	80
BIC® Super Clip Advance.....	86
BIC® Super Clip Ecolutions®.....	83
BIC® Tri-Tone Twist.....	129
BIC® Velleda® White Board Marker Fine.....	156
BIC® Velleda® White Board Marker Grip.....	157
BIC® Visa® Colouring Set.....	186
BIC® Visa® set of 6 felt pens.....	178
BIC® Wide Body™.....	90

	PAGE
BIC® Wide Body™ Chrome.....	94
BIC® Wide Body™ Ecolutions®.....	93
BIC® Wide Body™ Metal.....	126
BIC® Wide Body™ Mini Digital.....	95
BIC® Wide Body™ Mini Digital Chrome.....	95
BIC® XS Finestyle.....	146
Click pen.....	196
Conté® by BIC® Colouring Set.....	188
Conté® set of 6 colouring pencils.....	180
Sleek Stylus Executive pen.....	202
Sleek Stylus Matt pen.....	202
Sleek Stylus pen.....	202
Sprout™.....	172
Striped Grip pen.....	198
Tipp-Ex® Mini Pocket Mouse britePix™.....	190
White Striped Grip pen.....	200

BIC® STICKY NOTES

BIC® 50 mm x 75 mm Adhesive Notepads... ..	208
BIC® 68 mm x 75 mm Adhesive Notepads... ..	210
BIC® 75 mm x 75 mm Adhesive Notepads... ..	212
BIC® 75 x 75 Adhesive Notepad with Flag Booklet.....	228
BIC® 75 x 75 Booklet.....	232
BIC® 75 x 127 mm Non-Adhesive Scratch Pad.. ..	244
BIC® 96 x 152 mm Non-Adhesive Scratch Pad.. ..	245
BIC® 101 mm x 101 mm Adhesive Notepads... ..	220
BIC® 101 mm x 152 mm Adhesive Notepads.. ..	222
BIC® 101 mm x 75 mm Adhesive Notepads & Alternating Sheet Imprint.....	216
BIC® 101 x 75 Booklet.....	230
BIC® 150 x 150 mm Booklet Organiser.....	238
BIC® 150 x 150 mm Booklet with Pen Loop... ..	240
BIC® Clic Stic Mini Organiser & BIC® Clic Stic Mini Digital Organiser.....	234
BIC® Flag Booklet.....	226
BIC® Medium Adhesive Die Cut Notepads... ..	218
BIC® Small Adhesive Die Cut Notepads.....	214

BIC® NOTEBOOKS

BIC® Notebooks Dual A5.....	250
BIC® Notebooks Dual A6.....	252

OFFICE ACCESSORIES

Mouse pad.....	258
Sublimation mug.....	259

BIC® LIGHTERS

BIC® 3D Case.....	295
BIC® Aluminium Flat Case.....	292
BIC® Clip Case.....	293
BIC® J23 Digital Lighter.....	274
<small>New colour!</small> BIC® J23 Lighter.....	272
BIC® J25 Digital Lighter.....	270
<small>New!</small> BIC® J25 Lighter.....	268
BIC® J26 Digital Lighter.....	278
<small>New colour!</small> BIC® J26 Lighter.....	276
BIC® J38 Digital Lighter.....	282
BIC® J38 Lighter.....	280
BIC® J39 Digital Lighter.....	286
BIC® J39 Lighter.....	284

	PAGE
BIC® Mega Lighter.....	288
BIC® Pocket Ashtray.....	296
BIC® Styl'it Fashion Case.....	294
BIC® Styl'it Luxury Case.....	290

BIC® SHAVERS

BIC® Comfort 2.....	302
BIC® Comfort2 Lady.....	308
BIC® Flex3 Classic™.....	304
BIC® Flex4.....	306
BIC® Pure 3® Lady.....	310
BIC® Soleil® Bella® Lady.....	312

BIC® BAGS

BIC® Classic Backpack.....	320
BIC® Drawstring Backpack.....	318
BIC® Multi-use Pouch.....	322

TECHNOLOGY

Skross® Pro Light USB.....	352
Skross® World Adapter MUV USB.....	353
Skross® World To Europe USB.....	351
T'nB® 4K Action Camera.....	349
T'nB® Active Noise Reduction Headphones.. ..	347
T'nB® Art Speaker.....	335
T'nB® Be Colour Headphones.....	343
<small>New!</small> T'nB® Hashtag bluetooth® Headphones.....	345
T'nB® HD Action Camera.....	348
T'nB® Juke Speaker.....	334
T'nB® Kids Headphones.....	341
T'nB® Legend Headphones.....	344
T'nB® Live in earphones.....	338
T'nB® Lumy Wired Mouse.....	329
<small>New!</small> T'nB® Lumy Wireless Mouse.....	330
T'nB® Mini Wireless Mouse.....	328
<small>New!</small> T'nB® Motion Bluetooth® Earphones.....	340
T'nB® Rainbow Mouse.....	327
T'nB® Shine Bluetooth® Headphones.....	346
T'nB® Slim Power Bank 6000 mAh.....	333
T'nB® Sport Bluetooth® Headphones.....	342
T'nB® Sport Bluetooth® Speaker Ball.....	336
<small>New!</small> T'nB® Steel Bluetooth® Earphones.....	339
T'nB® Stone PowerBank 4000 mAh & 6600 mAh.....	331
T'nB® Ultra-slim PowerBanks 4000 mAh & MFi adapter.....	332
T'nB® Vintage Bluetooth® Speaker.....	337

BIC® PACKAGING

BIC® Cotton drawstring pouch.....	357
Black Two-Piece Gift Box.....	356
Black Velvet Pouch.....	355
Box of 50 Metal Styl'it Case.....	357
Carton Black & Silver colour gift box.....	355
Cello Wrap.....	355
Count Box.....	357
Count Box 10u Cases.....	357
Frosted Pouch.....	355
Hinged Gift Box.....	356
Plastic Bag.....	357
See-Through Gift Box.....	356
Tray of 10 writing instruments.....	357



Colour table

Nuancier de couleurs / Gama de colores / Farbindex / Tavolozza dei colori

01 1E	10	blanc blanco weiss bianco	57	blanc opaque blanco opaco opak weiss bianco opaco	51	transparent transparente transparentweiss trasparente	69 2E	blanc glacé blanco frosted gefrostet weiss bianco frosted	3C	blanc perlé blanco perlado perlweiß bianco perla
12		jaune amarillo opak gelb giallo	8G 23	jaune light amarillo light hellgelb giallo chiaro	2F	jaune acide amarillo ácido Säure Gelb giallo acido	63	jaune frost amarillo frosted gefrostet gelb giallo frosted	71	orange glacé naranja frosted gefrostet orange arancio frosted
92		orange clear naranja clear transparentorange arancio trasparente	4D	jaune clear amarillo transparente Transparentes Gelb giallo clear	8D	jaune pastel amarillo pastel pastelgelb giallo pastello	1G	orange fluo naranja ácido säureorange arancio acido	10 22	orange naranja opak orange arancio
03 8E	20	rouge rojo opak rot rosso	4G	rouge métallisé rojo metálico metallrot rosso metallizzato	87	rouge clear rojo clear transparentrot rosso trasparente	08 71	bordeaux rojo burdeos burgunderrot bordeaux	14	rose rosa rosa rosa
3H		corail rose rosa coral korallenrosa rosa corallo	1P 27	rose fluo rosa ácido säurerosa rosa acido	5C	magenta fucsia pink fucsia	95	rose clair rosa clear transparentrosa rosa trasparente	2C	rose métallisé rosa metálico metallpink rosa metallizzato
26 03		or oro gold oro	4B	violet glacé violeta frosted gefrostet violet viola frosted	2D	lilas violeta lila viola	84	pourpre pastel púrpura pastel pastellila viola pastello	93 93	pourpre clair púrpura clear transparentlila viola trasparente
39		pourpre glacé púrpura frosted gefrostet lila viola frosted	13 25	pourpre púrpura opak lila viola	7G	violet métallisé violeta metálico metallilila viola metallizzato	3D	bleu caraïbe azul caribeño karibikblau azzurro caraibico	24 53	bleu clair azul claro hellblau azzurro chiaro
67 67		bleu glacé azul frosted gefrostet blau azzurro frosted	86	bleu clair azul clear transparentblau azzurro trasparente	83	bleu pastel azul pastel pastellblau azzurro pastello	34 34	bleu métallique azul metálico metallblau blu metallizzato	1D	bleu foncé métallisé azul metálico oscuro metall Dunkelblau blu scuro metallizzato
04		bleu azul opak blau blu	40	bleu nuit glacé azul oscuro frosted gefrostet dunkelblau blu frosted	89	bleu marine clair azul oscuro clear transparentdunkelblau blu trasparente	50	bleu royal azul real königsblau blu royal	07 10E	bleu marine azul marino opak marineblau blu
25 52		bleu nuit azul oscuro dunkelblau azzurro scuro	85	vert pastel verde pastel pastelgrün verde pastello	68	vert glacé verde frosted gefrostet grün verde frosted	59 29	vert pomme verde manzana äpfelgrün verde mela	2G	vert fluo verde ácido säuregrün verde acido
88 88		vert clair verde clear transparentgrün verde trasparente	6C	vert herbe verde hierba grasgrün verde mela	82	vert foncé glacé verde oscuro frosted gefrostet dunkelgrün verde scuro frosted	05 60	vert verde opak grün verde	20 7E	vert foncé verde oscuro opak dunkelgrün verde scuro
2B		kaki jungla opak dschungelgrün kaki	3B	kaki glacé jungla frosted gefrostet dschungelgrün kaki frosted	29	bronze oro viejo brunze oro brunito	47	argent plata silber argento	18	métal metal metall metallizzato
06		gris foncé gris oscuro grau grigio	27	gris foncé gris oscuro dunkelgrau grigio scuro	02 3E	noir negro opak schwarz nero	4A	pure argent plata silber argento puro	75	argent métallisé plata metálico metallsilber argento metallizzato
5A		bleu ardoise azul pizarra schieferblau blu ardesia	7A	gris ombre gris oscuro anthrazit grigio	35	chrome cromo premiumsilber cromato	8A	bronze bronce brunze bronzio	8H	gris foncé frost gris oscuro clear transparentesdunkelgrau grigio scuro trasparente

The colours shown above are for reference only. Actual colour may vary slightly depending on the product / Ces couleurs sont de nature indicative et non contractuelle. Leur rendu peut donc varier en fonction de la matière sur laquelle elle sont apposées / Los colores arriba indicados, son sólo una referencia. El color real puede variar dependiendo del producto / Die oben angeführten Farben dienen ausschließlich der Veranschaulichung. Leichte Abweichungen können je nach Produkt entstehen / I colori esposti sopra sono solo un riferimento. I colori reali possono essere leggermente diversi, a seconda del prodotto.

Make it simple!

**Save time when calculating your final price.
Look at the quantity column for the price and that's it!**

NO SET UP OR SCREEN CHARGES

Except specific Custom Made Trim. See below.

PERSONALISATION INCLUDED

Price includes personalisation in one position.

CUSTOM MADE COLOURS FOR TRIM

- An “unlimited” choice of barrel and trim colours for orders over 10.000 units.
 - A completely personalised pen in any colour you want.
 - Available on an extensive range of products.
 - A value added service with only a short additional lead time.
 - Available for barrel and trims of: BIC® Round Stic®, BIC® Media Clic, BIC® Media Clic Grip*, BIC® Clic Stic, BIC® Super Clip, BIC® Wide Body™**, BIC® XS Finestyle
- *For personalised barrel and grip MOQ is 20.000 units
** For personalised section MOQ is 25.000 units

- Set up charge per trim..... 790,00 €
- Set up charge per trim (repeat orders) 445,00 €
- Set up charge trim from 100.000 units Free of charge

OTHER CHARGES

- Pre-production order (transport not included) 129,00 €/order*
- Available for BIC® Writing Instruments (10 units), BIC® Lighters (10 units), BIC® Flag Booklet (10 units) or BIC® Bags (1 unit).
- Ink cartridge change when available (handling cost only)..... 0,14 €/unit
- BIC® Sticky Notes: Charge for a specific custom made colour as a 5th colour 105,00 €
- Cancellations or changes to orders after artwork approval (Subject to BIC Graphic Europe acceptance).
Fixed cost per change (extra costs such as tooling, components or finished product to be added)..... 70,00 €
- britePix™ individual personalisation..... 65,00 €/order**

*Not available for BIC® Sticky Notes and digital lighters with Puffy, Puffy Glitter, Metallic, Glow in the dark, Sandy, Holographic and UV finishes.

**britePix™ individual personalisation allows you to change the texts and images of your artwork, giving you a personalised imprint for each of the products in your order. Both texts and information regarding image changes should be provided in an Excel. Should you also require changes in the positioning of the texts and images there will be an additional charge.

Terms and conditions of sale apply, please refer to www.bicgraphic.eu

FR> Commandez en toute simplicité !

Gagnez du temps en calculant votre prix d'achat.

Regardez la colonne correspondant à votre quantité pour obtenir le prix et c'est tout!

SAIS FRAIS TECHNIQUE NI FRAIS D'ÉCRAN

Sauf les couleurs Pantone spécifiques - voir ci-dessous.

PERSONNALISATION INCLUSE

Les prix comprennent la personnalisation sur une position, à l'exception des éléments d'écriture métalliques.

CUSTOM made couleurs par attributs

Un choix "illimité" de couleurs de corps et d'attributs à partir de 10.000 pièces.

Un stylo entièrement personnalisé dans les couleurs que vous souhaitez.

Disponible pour une large gamme de produits.

Un service supplémentaire à forte valeur ajoutée avec un délai de production additionnel réduit.

Disponible pour les corps et attributs de: BIC® Round Stic®, BIC® Media Clic, BIC® Media Clic Grip®, BIC® Clic Stic, BIC® Super Clip, BIC® Wide Body™**, BIC® XS Finestyle

*Pour un corps et grip personnalisés MOQ de 20.000 pièces.

**La quantité minimum de commande pour personnaliser une section est de 25.000 unités. La technique par attribut...790,00€

Frais technique par attribut (renouvellement de commande)...445,00€

Frais technique par attribut à partir de 100.000 unités...Gratuit

AUTRES CHARGES

Échantillon de pré-production (Transport non compris)... 129,00 €/commande*

Disponible pour les instruments d'écriture BIC® (10 unités), les briquets BIC® (10 unités), les BIC® Flag Booklet (10 unités) ou les sacs BIC® (1 unité).

Changement de cartouche d'encre quand disponible...0,14 €/unité

BIC® Sticky Notes: Frais pour une couleur spécifique faite sur mesure en tant que cinquième couleur...105,00 €

Modification et annulations de commandes après validation de la fiche de marquage (sujet à l'approbation de BIC Graphic Europe): 70€ /modification et annulation.

Coût fixe par changement (coûts supplémentaires tels que l'outillage, les composants ou le produit fini à ajouter)... 70,00 €

britePix™ personnalisation individuelle...65,00 €/commande**

*Non disponible pour les BIC® Sticky Notes et les briquets numériques avec finitions Puffy, Puffy Glitter, Metallic, Glow in the dark, Sandy, Holographic et UV.

**britePix™ personnalisation individuelle vous permet de changer les textes et image de votre photomontage, vous offrant un marquage personnalisé sur chacun des produits de votre commande. Toute information ou image devra être fournie sous un fichier Excel. En cas de modification de la position des textes et images (par rapport à la zone standard) un supplément sera facturé.

Les conditions générales de vente s'appliquent, veuillez vous référer à www.bicgraphic.eu

DE> Einfach und übersichtlich!

Sparen Sie Zeit beim Berechnen Ihrer Preise.

Nehmen Sie einfach die entsprechenden Staffelpreise – das war's!

KEINE EINRICHTUNGS- ODER SIEBKOSTEN

Ausgenommen davon sind die Sondereinfärbungen, siehe unten.

PERSONALISIERUNG INBEGRIFFEN

Preis inklusive Personalisierung an einer Position außer bei Metall-Schreibgeräten.

SONDEREINFÄRBUNGEN FÜR AUSSTATTUNGSELEMENTE

Unbegrenzte Farbauswahl bei Schaft und Ausstattungselementen bei einer

Mindestbestellmenge ab 10.000 Stück.

Ein vollständig personalisierter Kugelschreiber in Ihrer Wunschfarbe.

Verfügbar für ein umfassendes Sortiment an Bestsellern.

Eine hervorragende Serviceleistung bei nur geringfügig längeren Lieferzeiten.

Verfügbar für Schäfte und Zierleisten von: BIC® Round Stic®, BIC® Media Clic, BIC®

Media Clic Grip®, BIC® Clic Stic, BIC® Super Clip, BIC® Wide Body™**, BIC® XS Finestyle

*Für personalisierten Schaft und Griffzone liegt die Mindestbestellmenge bei 20.000 Stück.

**Für personalisierte Spitze liegt die Mindestbestellmenge bei 25.000 Stück.

Einrichtungskosten pro Element...790,00€

Einrichtungskosten pro Element (Folgeauftrag)...445,00€

Einrichtungskosten pro Element ab 100.000 Stück...Kostenfrei

SONSTIGE KOSTEN

Freigabemuster (ohne Transport)... 129,00 €/Auftrag*

Verfügbar für BIC® Schreibgeräte (10 Stück), BIC® Feuerzeuge (10 Stück), BIC® Flag

Booklet (10 Stück) oder BIC® Taschen (1 Stück).

Minenwechsel, wenn möglich. Pro Mine...0,14 €/Stück

BIC® Sticky Notes: Kosten für eine kundenspezifische Farbe als 5. Farbe...105,00 €

Änderungen nach Erteilung der Druckfreigabe (bedürfen der Zustimmung durch BIC Graphic Europe).

Kosten pro Änderung (zusätzliche Kosten wie Werkzeuge, Komponenten oder fertige Produkte werden hinzugefügt)... 70,00 €

britePix™ individuelle Personalisierung...65,00 €/Auftrag**

*Nicht verfügbar für BIC® Sticky Notes und digitale Feuerzeuge mit Puffy-, Puffy Glitter-, Metallic-, Glow-in-the-dark-, Sandy-, Holographic- und UV-Oberflächen.

**britePix™ individuelle Personalisierung bietet Ihnen die Möglichkeit, Texte und Abbildungen Ihres Layouts auszutauschen und somit einen individuell personalisierten Druck für jeden einzelnen Artikel Ihres Auftrags zu erhalten. Sie übermitteln uns Text, Logo und alle weiteren Daten in einer Excel-Datei. Falls zusätzlich Positionsänderungen bei Text oder Abbildungen erforderlich sind, fallen Zusatzkosten an.

Es gelten die allgemeinen Verkaufsbedingungen, siehe www.bicgraphic.eu

ES> ¡Lo hacemos simple!

¡Ahórese tiempo calculando el precio final.

Basta con buscar la columna de la cantidad que necesita y ¡ya está!

SIN GASTOS TÉCNICOS NI DE SERIGRAFÍA

Excepto colores de componentes personalizados. Ver a continuación.

PERSONALIZACIÓN DEL PRODUCTO INCLUIDA

El precio incluye la personalización en una posición excepto en los instrumentos de escritura metálicos.

COLORES PERSONALIZADOS PARA COMPONENTES

Un gran abanico de colores para el cuerpo y los componentes a partir de 10.000 unidades.

Un bolígrafo totalmente personalizado en el color deseado.

Disponible en una amplia gama de best sellers.

Un servicio de valor añadido en un tiempo de entrega adicional muy reducido.

Disponible para cuerpo y componentes de: BIC® Round Stic®, BIC® Media Clic, BIC® Media Clic Grip®, BIC® Clic Stic, BIC® Super Clip, BIC® Wide Body™**, BIC® XS Finestyle

*Personalizar cuerpo y grip tiene una MOQ de 20.000 unidades.

**La cantidad mínima para personalizar de la sección es 25.000 unidades.

Costes fijos de impresión por componente...790,00€

Costes fijos de impresión por componente (pedidos de repetición)...445,00€

Costes fijos de impresión para 100.000 unidades...Sin cargo

OTROS CARGOS

Muestras pre-producción (Transporte no incluido)... 129,00 €/pedido*

Disponible para BIC® Writing Instruments (10 unidades), BIC® Lighters (10 unidades), BIC® Flag Booklet (10 unidades) o BIC® Bags (1 unidad).

Cambio del cartucho de tinta si está disponible...0,14 €/unidad

BIC® Sticky Notes: Cargo para un 5º color hecho a medida...105,00 €

Cancelaciones o cambios en los pedidos después de la aprobación del arte final (sujeto a la aceptación de BIC Graphic Europe).

Modificaciones de pedidos después de aprobación del arte final (sujeto a la aceptación por parte de BIC Graphic Europe) por cambio... 70,00 €

britePix™ personalización individual...65,00 €/pedido**

*No disponible para BIC® Sticky Notes y digital lighters con acabados Puffy, Puffy Glitter, Metallic, Glow in the dark, Sandy, Holographic y UV.

**La personalización individual britePix™ le permite cambiar los textos e imágenes de su dibujo, ofreciéndole una impresión personalizada para cada uno de los productos de su pedido. Tanto los textos como la información de cambios de las imágenes se deberían facilitar en una hoja Excel. Si se requieren también cambios en la posición de los textos e imágenes, se aplicará un cargo adicional.

Aplicación de los términos y condiciones de venta, por favor, consulta www.bicgraphic.eu

IT> Facilissimo!

Risparmia tempo quando calcoli il prezzo finale.

Guarda la colonna quantità e hai già il tuo prezzo!

NESSUN COSTO IMPIANTO

Ad eccezione di prodotti con fusto di colore speciale, vedi sotto.

PERSONALIZZAZIONE INCLUSA

Il prezzo comprende la personalizzazione in una posizione eccetto sugli strumenti di scrittura in metallo.

COLORI CUSTOM MADE PER I PARTICOLARI

Una illimitata scelta di colori per il corpo e i particolari delle tue penne per ordini a partire da 10.000 pezzi.

Una penna completamente personalizzata con qualsiasi colore desiderate.

Disponibile su un'ampia gamma di best seller.

Un servizio di grande valore con un solo piccolo aumento dei tempi di spedizione.

Disponibile per fusto e decori di: BIC® Round Stic®, BIC® Media Clic, BIC® Media

Clic Grip®, BIC® Clic Stic, BIC® Super Clip, BIC® Wide Body™**, BIC® XS Finestyle

*MOQ per corpo e grip personalizzati: 20.000 pezzi

**Per la sezione personalizzata l'MOQ è 25.000 unità

Costo di impianto per ordine...790,00€

Costo di impianto per ordine (riassortimenti)...445,00€

Costo di impianto per ordine oltre le 100.000 unità...Gratuito

COSTI AGGIUNTIVI

Campione pre-produzione (Trasporto escluso)... 129,00 €/per ordine*

Disponibile per strumenti di scrittura BIC® (10 unità), accendini BIC® (10 unità),

BIC® Flag Booklet (10 unità) o borse BIC® (1 unità).

Costo cambio colore refill dove possibile. Costo unitario...0,14 €/per unità

BIC® STICKY NOTES: Costo di uno specifico colore personalizzato come quinto

colore...105,00 €

Cancelazione e/o modifiche dopo approvazione della bozza e della conferma, (saranno soggetti all'accettazione di BIC Graphic Europe).

Cambio dell'ordine dopo l'approvazione della bozza grafica, costo unitario per cambio... 70,00 €

Personalizzazione individuale britePix™...65,00 €/per ordine**

*Non disponibile per i BIC® Sticky Notes e gli accendini digitali con finiture in rilievo, Puffy Glitter, Glow in the dark, Sandy, Metallic, Holographic e UV.

**La personalizzazione individuale in britePix™ consente di modificare i testi e le immagini della vostra bozza dando un'impronta personalizzata per ciascuno dei prodotti nel vostro ordine. Entrambi i testi e le informazioni relative alle modifiche di immagini dovrebbero essere forniti in un file Excel. Se avete bisogno anche di cambiamenti nel posizionamento dei testi e delle immagini, è previsto un costo aggiuntivo.

Per termini e condizioni di vendita consultare gentilmente: www.bicgraphic.eu



www.bicgraphic.eu



6,00 €

©2019 BIC Graphic Europe